

USER MANUAL



Laboratory centrifuge **MPW M-BASIC**

Read before use!

Serial number of centrifuges:

For centrifuges with serial no (SN): from 102MB005121







This manual has been prepared with particular care. At any time and without prior notice, MPW MED. INSTRUMENTS can introduce improvements and changes in the manual resulting from noticing typographical errors or improving the device. All rights reserved. No part of this document may be modified, distributed, published or reproduced without the consent of MPW MED. INSTRUMENTS.

You can find the current version of the manual on our website under:

<https://mpw.pl/en/to-download/user-manuals>

Warning signs:

	WARNING! Warning of potential injury or health risk.
	DANGER! Electric shock hazard with possible serious injury or death.
	DANGER! Biohazard with potential for risk to health or death as a consequence.
	DANGER! Risk of explosion with potential for severe injury or death as a consequence.

Content

1. Application	5
2. Technical specification	5
2.1 Environmental conditions	6
3. Installation	6
3.1 Content of package.....	6
3.2 Location.....	7
3.3 Current protection.....	7
4. Safeness	8
4.1 Operating personnel	8
4.2 Safety hints.....	8
4.3 Maintenance conditions	8
4.4 Residual risk	10
5. Operating	10
5.1 Centrifuge description	10
5.2 Control elements.....	10
5.3 Control panel.....	10
5.4 Name plate.....	11
5.5 Inserting the rotor and accessories	12
5.6 Filling the rotor	13
5.7 Control device	14
5.8 Entering parameters	14
5.9 Safety features	14
6. Control elements	15
6.1 Program selection.....	15
6.2 Default settings	15
6.3 Unit selection RPM / RCF	15
6.4 Editing the program	15
6.4.1 <i>Spin time adjustment</i>	16
6.4.2 <i>Spin speed adjustment (RPM)</i>	16
6.4.3 <i>Relative centrifugal force adjustment (RCF)</i>	16
6.5 Advanced program parameters.....	16
6.6 Service menu	17
7. Centrifuging	19
7.1 Centrifuging with set time.....	19
7.2 SHORT mode	21
7.3 Continuous spin mode (HOLD mode)	21
7.4 Cancel the centrifugation.....	21
7.5 Changing parameters during centrifuging.....	22
8. Service life, maintenance and chemical resistance	22
8.1 Service life of equipment	22
8.2 Maintenance of the centrifuge.....	23
8.3 Maintenance of equipment.....	24
8.4 Sterilization	24
8.4.1 <i>Autoclaving</i>	25
8.5 Chemical resistance	26
9. Troubleshooting	27
9.1 Opening the cover after an error.....	27
9.2 Emergency cover release	27
9.3 Unbalance	27
9.4 General errors	28

9.5 Error messages.....	28
10. Guarantee, repairs	29
11. Transport, storage, disposal	29
11.1 Transport and storage	29
11.2 Transport and storage conditions	30
11.3 Disposal.....	30
12. Manufacturer's information.....	31
13. Annexes	31
A. Optional accessories	
B. Declaration of conformity (CE, ROHS 2)	
C. Declaration of decontamination (repair / return)	
D. Dependency nomogram RPM / RCF	

1. Application

MPW M-BASIC centrifuge is a tabletop laboratory centrifuge. The device is designed especially for In Vitro diagnostics (IVD) and is used to separate samples taken from human, animal and plant organisms into components of different densities under the influence of centrifugal force, to provide information about their biological state and for other analytical works.

The design of the centrifuge ensures easy operation, safe operation and a wide range of applications in laboratories for medical, biochemical and other analyzes.

The centrifuge is not biotight.

It is not allowed to centrifuge corrosive, flammable and explosive substances in the centrifuges.

2. Technical specification

Manufacturer	"MPW MED. INSTRUMENTS" SPÓŁDZIELNIA PRACY, Boremlowska 46 Street, 04-347 Warsaw					
Type	MPW M-BASIC					
Main's voltage (L1+N+PE),	230V	100V	110V	115V	120V	127V
	±10%	±5%				
Frequency	50/60Hz					
Device power (max.)	120W					
Current protection	T 2A			T 3,15A		
Capacity (max.)	8x15ml, 2x50ml, 2xPRP(60ml)					
Speed - RPM	300 ÷ 4000 rpm, (step 100 rpm)					
Force - RCF	10 ÷ 2469 x g (displayed 2500 x g) step 10 x g (for value <100) step 100 x g (for value ≥100)					
Running time	1 ÷ 99 min., step 1 min					
Time counting	descending from pressing START / descending from reaching the programmed speed					
Short-time operation mode – SHORT	yes					
Continuous operation mode – HOLD	yes					
Menu languages	English					
User programs	5					
Acceleration (ACEL)	FAST, SOFT					
Deceleration (DECEL)	FAST, SOFT, RUN OUT					
Electromagnetic compatibility	according to EN 61326-2-6:2006					
Degree of protection (according to PN-IEC 34-5)	IP20					
Dimensions:						
Height (H)	300 mm					
Width (W)	365 mm					
Depth (D)	450 mm					
Height with open cover (Hoc)	572 mm					
Noise level	≤ 56 dB					
Weight 230V	approx. 21 kg					
Weight 120V	approx. 23 kg					

2.1 Environmental conditions

- The device may only be used indoors.
- The permissible ambient temperature is 2°C to 40°C.
- Maximum allowed relative humidity 80% at temperature up to 31°C decreasing linearly to 50% relative humidity at 40°C.
- The mains voltage fluctuations must not exceed $\pm 10\%$ of the nominal voltage.
- Maximum altitude 2,000 m above sea level.
- Overvoltage category II.
- Pollution degree 2.

3. Installation

Open the package. Remove the box containing the accessories. Take out centrifuge from the container. Save the box and packing material in case of service shipment. Connect the centrifuge to the power supply and open the cover, then remove the safety locking the rotor by following the pictures below.

1

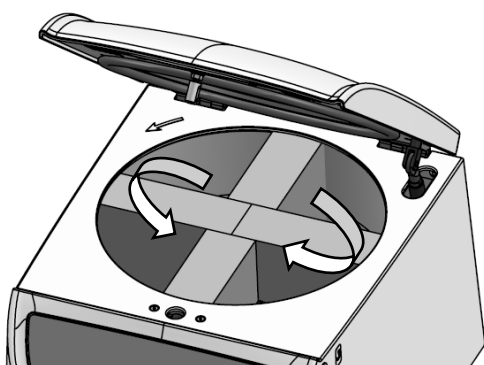

2

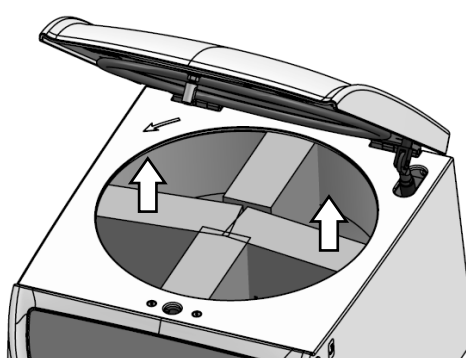

3

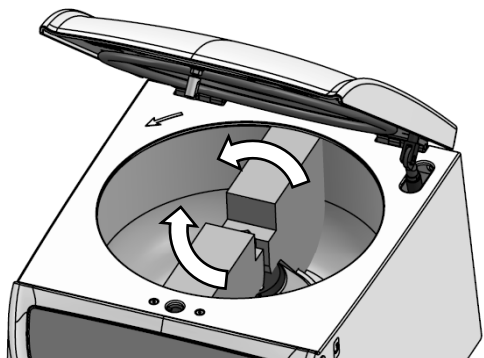

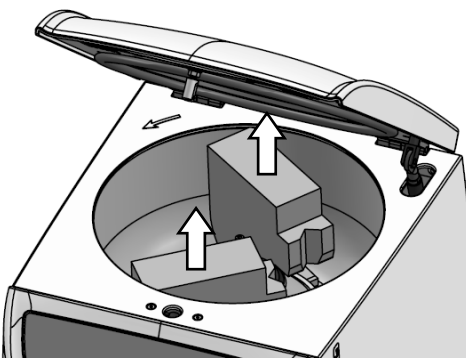

4



3.1 Content of package

Name	pcs.	Catalog no. (REF)
Centrifuge MPW M-BASIC	1	102MB/2-56 (230V 50/60Hz) or 102MB/1-56 (120V 50/60Hz)
Complete clamp	1	18626
Spanner for the rotor	1	18672
Spanner for emergency opening of the cover	1	18640
Power cord 230V or 120V	1	17866 or 17867
Fuse for version 230V 50/60Hz	2	18675
Fuse for version 120V 50/60Hz	2	18676
vaseline 20ml	1	17201
Permanent marker	1	18678
User manual	1	See page 1.

3.2 Location

	<ul style="list-style-type: none">▪ Lifting and carrying the centrifuge by one person may lead to back injuries. There is a risk of injury when lifting and carrying heavy loads.▪ The centrifuge should be lifted and transported with a sufficient number of helpers. Use a transport aid to transport the centrifuge.▪ The device should be lifted by its bottom and placed directly on a suitable laboratory table.▪ The centrifuge should be set so that access to the power switch is not difficult.▪ A safe installation site must be provided.▪ Do not place the centrifuge near heaters and avoid direct sunlight.▪ The table on which the centrifuge is placed should be stable and have a flat, leveled top.▪ Leave a distance of 30 cm around the centrifuge to maintain the ventilation zone. Do not obstruct the ventilation openings (safety requirements in the event of an accident in accordance with EN 61010-020).▪ The laboratory table should be cleaned before placing the centrifuge on it.▪ The given parameters of the centrifuge are maintained for the ambient temperature range given in the technical data table.▪ When changing the place from cold to warm, water vapor condensation will occur inside the centrifuge. It is important to allow sufficient time for drying before restarting the centrifuge (min. 4 hours).
	<ul style="list-style-type: none">▪ The supply voltage must match the voltage specified on the rating plate. Laboratory centrifuges by MPW MED. INSTRUMENTS have a three-wire connection cord with a plug resistant to dynamic loads.▪ The power socket must have a safety pin.▪ It is recommended to install an emergency switch located far from the centrifuge near the exit from the room or outside the room.
	<ul style="list-style-type: none">▪ Before switching on, check whether the centrifuge is connected to power supply correctly. It is obligatory to use only power cord recommended by manufacturer.

3.3 Current protection



	The centrifuge is equipped with a current protection located in the mains power socket on the rear wall of the centrifuge.
---	--

4. Safeness

4.1 *Operating personnel*



	<ul style="list-style-type: none">▪ The laboratory centrifuge may be operated only by qualified laboratory personnel after getting acquainted with the operating manual.▪ The manual is an integral part of the device.▪ The manual should always be kept near the centrifuge.▪ The centrifuge cannot be operated improperly or inconsistently intended.▪ If the centrifuge is used in a manner inconsistent with the manufacturer's guidelines, the safety of the device operation may be impaired.
---	---





4.2 *Safety hints*

	<p>Rotor's maintenance</p> <ul style="list-style-type: none">▪ Lubricate the rotor pins with technical petroleum jelly (supplied with the rotor)▪ Use only accessories in good technical condition.▪ Use accurate preventive maintenance to prevent corrosion of the equipment (see chapter Maintenance).
	<p>Hazardous materials</p> <ul style="list-style-type: none">▪ It is not allowed to centrifuge toxic or infectious materials with damaged hermetic seal of the test tube. Proper disinfection procedures should always be performed if dangerous substances have contaminated the centrifuge or its accessories.

	<p>Explosive, flammable materials</p> <ul style="list-style-type: none">▪ It is not allowed to centrifuge explosive and inflammable materials.▪ Do not centrifuge substances that could react as a result of the application of high energy during centrifugation.▪ The centrifuge cannot work in an environment threatening with explosion.▪ It is not allowed to centrifuge materials that may generate inflammable or explosive mixtures when exposed to air.
---	--

4.3 *Maintenance conditions*

	<p>Centrifuge start-up</p> <ul style="list-style-type: none">▪ Prior to switching the centrifuge on, one shall carefully read all sections of this instruction to ensure smooth operation and avoid damages of this device or its accessories.▪ To protect the centrifuge against unbalance, fill in the test tubes up to the same weight.
	<p>Transport</p> <ul style="list-style-type: none">▪ The centrifuge must never be transported with the rotor installed on the motor axis.▪ Only transport with the transport lock in the chamber (see chapter Installation)

	<p>General hints</p> <ul style="list-style-type: none"> ▪ Only original equipment of centrifuges and spare parts should be used. ▪ In case of a malfunction of the centrifuge, use the MPW MED INSTRUMENTS factory service or its authorized representatives. ▪ It is not allowed to start the centrifuge if it is not installed correctly or the rotor and accessories are not properly mounted.
	<p>Centrifuge's substances</p> <ul style="list-style-type: none"> ▪ It is not allowed to exceed load limit set by the manufacturer. Rotors are intended for fluids of average homogeneous density equal to 1,2 g/cm³ or smaller.
	<p>Inspection procedures carried out by the operator</p> <p>Operator must pay special attention to the fact that the centrifuge parts of key importance due to safety reasons are not damaged. This remark is specifically important as for:</p> <ul style="list-style-type: none"> ▪ Centrifuge accessories and especially structural changes, corrosion, preliminary cracks, abrasion of metal parts. ▪ Screw connections. ▪ Control of execution of the guarantee yearly technical inspection of the centrifuge (after lapse of guarantee). <hr/> <ul style="list-style-type: none"> ▪ It is not allowed to lift or shift the centrifuge during operation and rest on it. ▪ It is not allowed to stay in the safety zone within 30 cm distance around the centrifuge neither leave within this zone any objects, e.g., glass vessels. ▪ It is not allowed to put any objects on the centrifuge. ▪ For centrifugation, only dedicated containers included in the equipment list and centrifuge tubes (commercial vessels made of centrifugal glass and plastic), the diameter, length and strength of which are appropriate, should be used. The use of test tubes outside the list should be agreed with the manufacturer of the centrifuge. ▪ Caution is expressly warned against the use of low-quality components. Breaking the glass or test tubes may cause dangerous vibrations of the centrifuge.
	<p>Inspections conducted by an authorized service</p> <p>The centrifuge should be inspected by an authorized service at least once a year (after the warranty period). For example, a corrosive environment could be the reason for more frequent inspection.</p> <p>The tests should end with issuing a validation protocol specifying the technical condition of the laboratory centrifuge.</p> <p>It is recommended to create a document that records all repairs and inspections. Both these documents should be kept in the place where the centrifuge is used.</p>
	<p>Cover opening</p> <ul style="list-style-type: none"> ▪ It is not allowed to use the emergency opening of the lid during spinning, because it may result in loss of health or life.

	Handling of rotors
	<ul style="list-style-type: none"> ▪ It is not allowed to use containers and round carriers with signs of corrosion or other mechanical damage. ▪ It is not allowed to centrifuge substances of high corrosive aggressiveness, which may damage materials and reduce mechanical properties of the rotor, buckets and round carriers.

4.4 Residual risk

The centrifuge is built according to the state-of-the-art and the recognized safety regulations. Nevertheless, remain some level of residual risk due to improper operation and malfunctions. It is possible to decrease residual risk by strictly applying user manual conditions and correcting malfunction which could threaten safety, immediately.

5. Operating

5.1 Centrifuge description

The MPW M-BASIC laboratory centrifuge is equipped with a modern microprocessor controller, a durable and quiet brushless induction motor and equipment that meets modern user requirements. The housing and cover are made of ABS plastic, the base is made of aluminum sheet. The cover is mounted on steel hinge axes, and from the front it is secured against opening it during rotation with an electromagnetic lock. The spin chamber is made of stainless steel.

5.2 Control elements

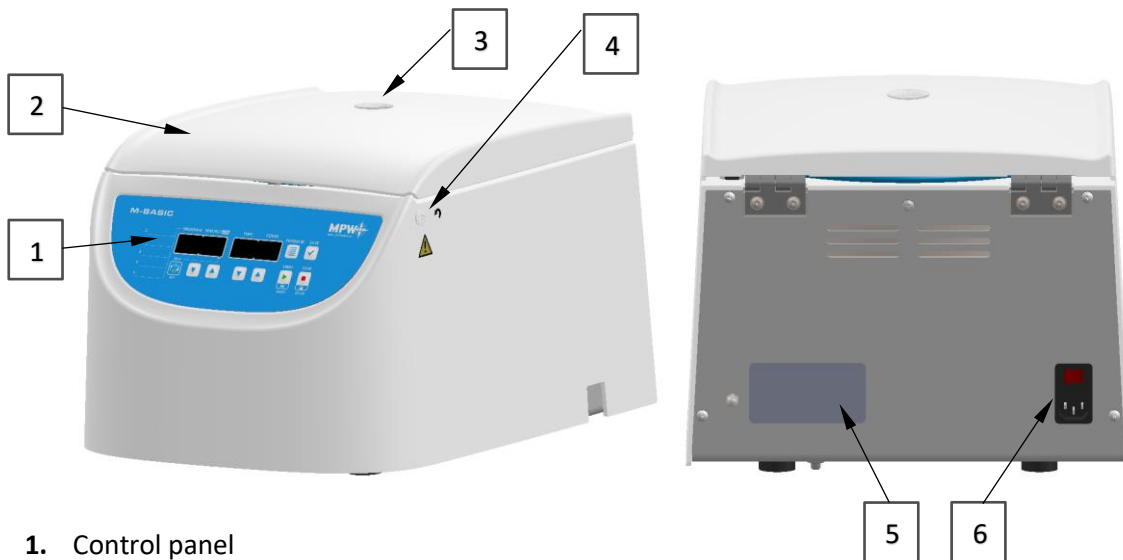

1. Control panel
2. Lid
3. Inspection glass
4. Point of emergency lid opening
5. Name plate
6. Main's switch

5.3 Control panel

The control panel located on the front wall of the housing is used to control the operation of the centrifuge.



	START	start spinning
	SHORT¹	short-term centrifugation
	STOP²	spin stop
	COVER	opening the cover
	SAVE	save the set centrifugation values under the program number / enter the service menu (hold for 8 sec.)
	PROGRAM	program selection / entry to advanced program parameters (hold down)
	UP	increase value / menu navigation
	DOWN	decrease value / menu navigation
	RPM/RCF	change display RPM / RCF
	Fields for the description of programs	It is possible for the user to manually describe the program on the control panel. For this purpose, use the pen included in the kit (catalog number 18678). For cleaning, use a soft cloth moistened with a liquid based on isopropyl alcohol.

¹ hold down the key.

² first press - spin stop with the currently selected deceleration characteristic, second press - the fastest possible stop.

5.4 Name plate

Model	MPW M-BASIC		
REF	102MB/2-56	2020	
n	4000 rpm	Fuse	2 A
AC	230 V	Freq.	50/60 Hz
P	120 W		
SN	102MB000120		
		ul. Boremłowska 46 04-347 Warszawa, POLAND	

Description of symbols on the plate:

Model	Centrifuge model		Product should not be disposed with other waste. Disposal according to national law.
	Catalog number		
	Date of manufacturing		Read user manual
n	Maximum rating		
Fuse	Fuse type		Marking the place of danger
AC	Power supply		QR code of the serial number
Freq.	Power source frequency		
P	Rated power		
	Serial number		
	Information about manufacturer		
	In Vitro laboratory device		
	CE compliance		

5.5 Inserting the rotor and accessories

- Connect the centrifuge to the power supply (mains socket at the back of the centrifuge).
- Turn on the centrifuge (switch on the back of the centrifuge).
- Open the cover of the centrifuge by pressing the **COVER** key . Before installing the rotor, check if the centrifugation chamber is free from contamination, e.g., dust, glass splinters, liquid residues that must be removed.
- Put the rotor on the motor axis by sliding it to the stop on the cone (keeping the axially between the rotor and the motor axis).
- Screw the clamp into the motor shaft (clockwise), then tighten it firmly with the rotor wrench.
- Fill test tubes outside the centrifuge.
- The rotor must be equipped with buckets in all seats. Please note that each container tilts by itself. Container suspension pins should be regularly lubricated with technical petroleum jelly.
- In the event of centrifugation in an angle rotor, test tubes (buckets) must be properly filled to avoid overflowing.
- The test tubes must be filled in such a way that the centrifugal material does not run out of the container during centrifugation.

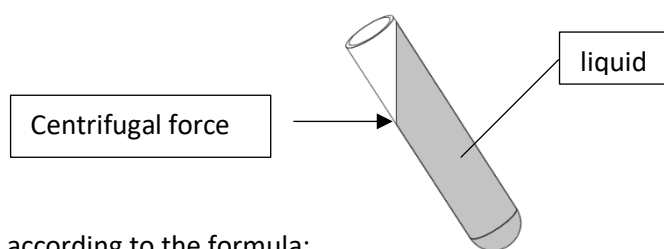

Fill the tubes according to the formula:

$$\text{Max liquid level} < \text{Tube height} - \frac{\text{Internal tube diameter}}{2}$$

Internal tube diameter

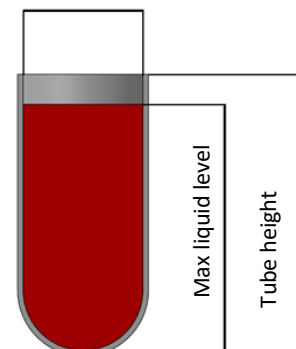



Align the dishes as thoroughly as possible to ensure that they work with minimal vibration.

- In order to ensure correct operation and increase the durability of the rotor, lubricate the rotor pins with technical petroleum jelly, used to suspend the containers and the pin cuts in the containers.
- In order to remove the rotor, remove the test tubes and containers, loosen the rotor clamp with the provided wrench, counterclockwise, and then, using both hands, grasp the rotor on opposite sides and remove it from the motor axis by pulling it upwards.

5.6 Filling the rotor

The M-BASIC centrifuge has a unique rotor that combines the advantages of traditional angular and horizontal rotors. It has two horizontal-angle sockets. This solution enables centrifuging at 45° and 90° without changing the rotor, but only by changing the position of the containers. To do this, remove the hanger and rotate it by 90° around its axis and put it back in the appropriate sockets.

Placing the pendant in the rotor sockets on the pins will result in a horizontal spin, while on the inlets - angular.

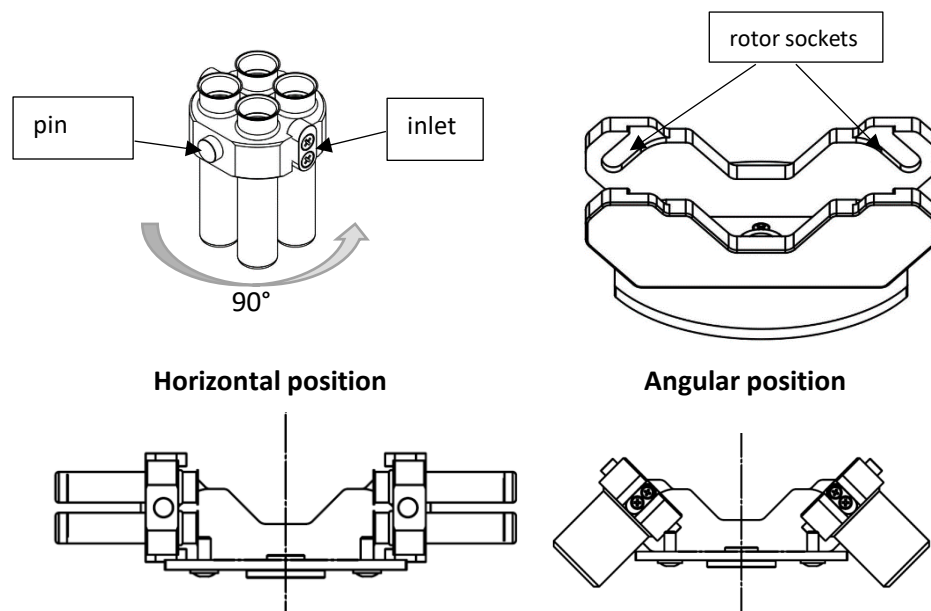

- Fix the rotor on the motor axis.
- **Ensure the balance of the masses!**
- Load opposite containers with the same accessories.
- Centrifugation of test tubes with different dimensions:
 - It is possible to centrifuge test tubes of different sizes simultaneously. However, it is absolutely imperative that the opposite containers and round carriers are the same.
 - Tubes should not only be inserted symmetrically, but also the containers and their suspensions should be evenly loaded.
- The rotor must be equipped with the same buckets in both seats. Please note that each container tilts by itself. Bucket suspension pins and rotor seats should be regularly lubricated with petroleum jelly.

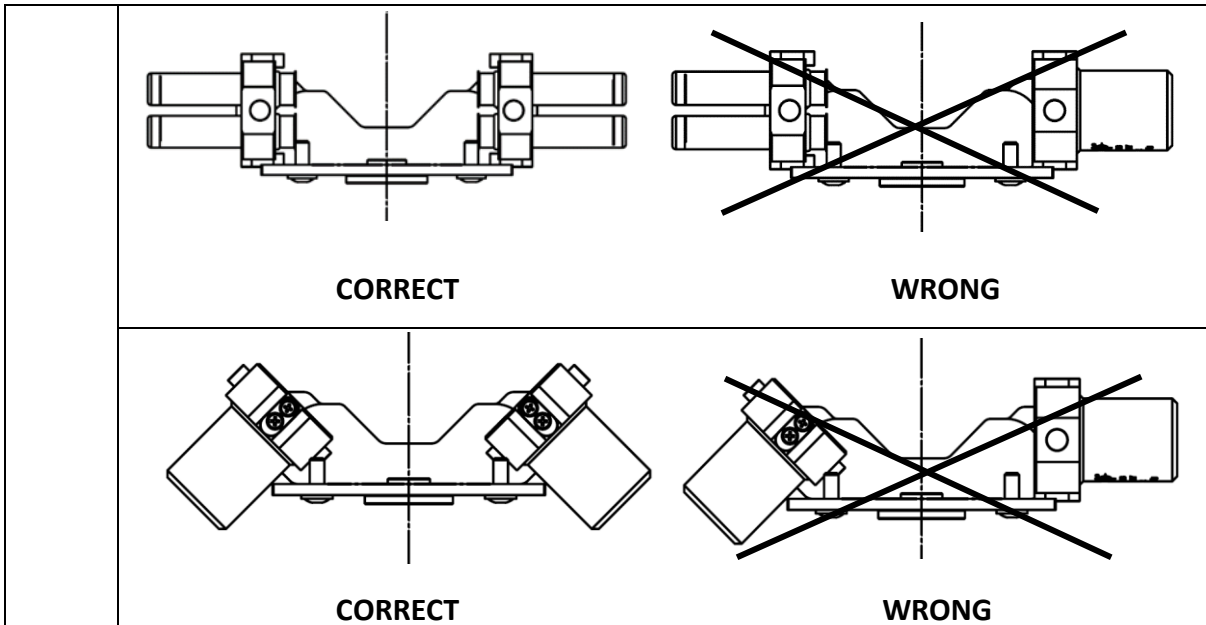

	<p>Filling tubes</p> <ul style="list-style-type: none"> ▪ Fill test tubes outside the centrifuge. ▪ Glass test tubes should be centrifuge tubes. Pay attention to the quality and appropriate thickness of the walls of glass test tubes. ▪ Fill the rotor equipment to the same weight to prevent unbalance of the centrifuge.
---	--

5.7 Control device

The microprocessor control system used in the centrifuge ensures a wide range of setting, implementing and reading operating parameters.

5.8 Entering parameters

The system for setting and reading parameters is a keyboard with clearly accessible control elements and a display. Easily readable indicators signaling the performed operations make it easier for the operator to program and register parameters and the state of the device.

5.9 Safety features



Cover lock

The centrifuge can be started only with properly closed cover. The cover can only be opened when the rotor has stopped. In case of emergency opening of the cover during operation, the centrifuge will immediately start braking to a complete stop.

Unbalance detecting

If an uneven load is detected during the operation of the centrifuge, the drive is turned off. An error message will appear on the display.

Rest state inspection

Opening of the centrifuge's cover with **COVER key**  is possible only with the rotor in the state of rest. Check that the symbol in the COVER field is continuously lit on the screen . Use the visor on the cover to make sure the impeller is not turning. Symbol when rotor brakes  flashes. Emergency opening of the cover during rotor spinning is not allowed.

6. Control elements

6.1 Program selection

The centrifuge has the ability to save 5 programs. Program selection is done by pressing the

PROGRAM key  until the desired program number is obtained.

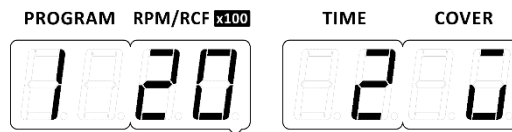

6.2 Default settings

By default, all programs are assigned the following default values:

- **RPM = 2000** – revolutions per minute
- **TIME = 2** [min] – spinning time

Parameters in the **Advanced program parameters** (see section 6.5):

- **ACC. = FAST** – acceleration characteristics
- **DEC. = SOFT** – deceleration characteristic
- **T.C. = SPD** – countdown of time from reaching the set rotational speed
- **COV. = ON** – automatic lid opening after completion of spinning – set on
- **SND. = ON** – sounds on – (the parameter is not saved by the programs)

6.3 Unit selection RPM / RCF

The display of the RPM and RCF units is changed using the **RPM / RCF** button . The currently selected information will be displayed, and then its value.

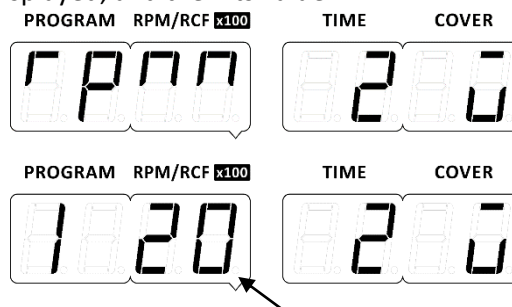

The **RPM** value is displayed without a dot (picture above), while the **RCF** value is shown with a dot as in the image below.

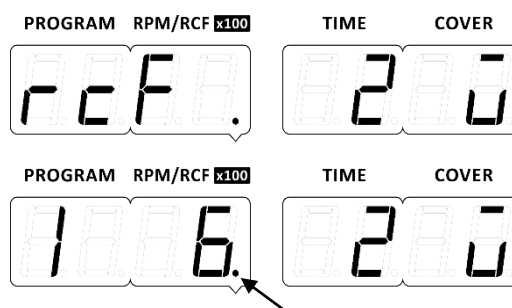

6.4 Editing the program

By changing the speed, time or advanced settings of the program, its edition begins, which is signaled by the flashing of the program number in the **PROGRAM** field.



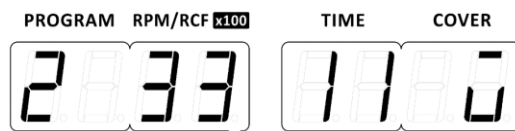

The program is edited with the direction keys ▲ and ▼ under the appropriate set field - (RPM / RCF) / (TIME). After setting the desired parameters, confirm with the **SAVE** button . The program will be saved under the previously selected number.

6.4.1 Spin time adjustment

The spin time can be adjusted from 1 ÷ 99 minutes by using the directional buttons ▲ ▼ below the TIME field. The time change step is 1 min.

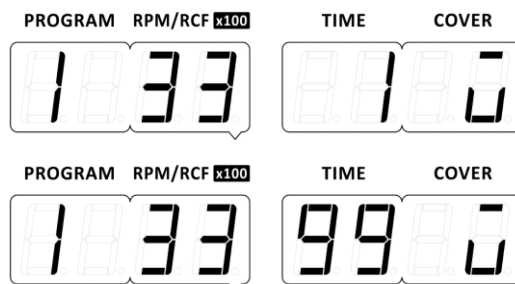

6.4.2 Spin speed adjustment (RPM)

Spinning revolutions can be adjusted in the range of 300 ÷ 4000 RPM using the direction keys ▲ ▼ under the RPM / RCF field. The speed change step is 100 rpm.

The actual spin speed is **100 times** faster than the centrifuge displayed on the screen. The pictures below display **300 RPM** and **4000 RPM**.

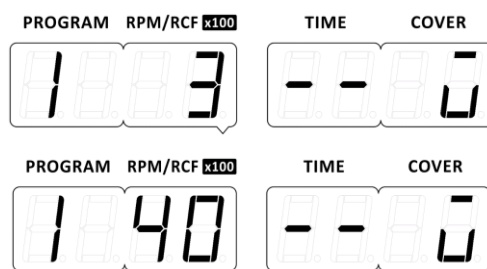



6.4.3 Relative centrifugal force adjustment (RCF)

The relative centrifugal force of the RCF can be adjusted in the range of 10 ÷ 2500 (x g) using the directional keys ▲ ▼ below the RPM / RCF field. The **RCF** value is shown with a dot. The RCF step is 10 (x g) with values below 100, and above 100 the step is 100 (x g).

The actual value is **100 times** greater than the centrifuge displayed on the screen. The pictures below show **10 RCF** and **2500 RCF**.



6.5 Advanced program parameters

Entering the advanced parameters of the program is done by holding down the **PROGRAM** button . Return to the basic settings is done by holding down the **PROGRAM** button .

The possible screens after entering the advanced program parameters are shown in the table below.

Selecting the adjustable parameter is done by pressing the direction keys ▲ ▼ in the RPM / RCF field and changing the value by pressing the direction keys ▲ ▼ in the TIME field.

From the advanced settings you can save the program with the **SAVE** button



Parameter / Value	Description
PROGRAM RPM/RCF x100 TIME COVER 	fast acceleration
PROGRAM RPM/RCF x100 TIME COVER 	soft acceleration
PROGRAM RPM/RCF x100 TIME COVER 	fast deceleration
PROGRAM RPM/RCF x100 TIME COVER 	soft deceleration
PROGRAM RPM/RCF x100 TIME COVER 	run deceleration
PROGRAM RPM/RCF x100 TIME COVER 	automatic opening of the lid after spinning enabled
PROGRAM RPM/RCF x100 TIME COVER 	automatic opening of the lid after spinning disabled
PROGRAM RPM/RCF x100 TIME COVER 	time counting from pressing START
PROGRAM RPM/RCF x100 TIME COVER 	time counting from reaching the set speed
PROGRAM RPM/RCF x100 TIME COVER 	acoustic signals off (not memorized in the program)
PROGRAM RPM/RCF x100 TIME COVER 	acoustic signals on (not memorized in the program)







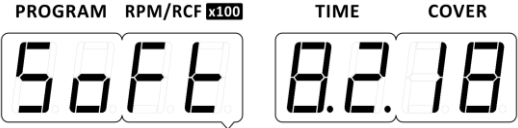
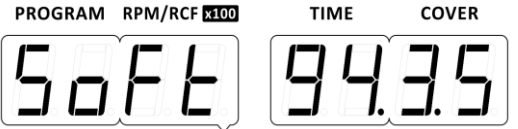

6.6 Service menu

The service menu is displayed by holding the **SAVE** key for **8 seconds** from the main screen level (in the loaded program mode)

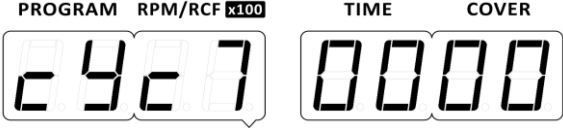

Changing the displayed parameters is done by pressing the direction keys ▲ ▼ (RPM / RCF). Exit and confirmation of selected menu parameters is done by pressing the **SAVE** key .

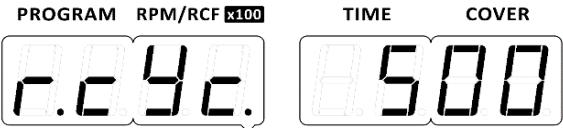
The table below shows the structure of the service menu.

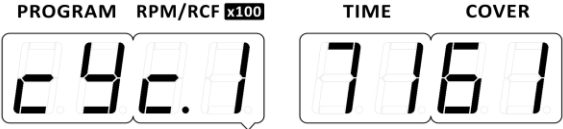
Screen	Description
 	<p>Program version</p> <p>Driver program version</p> <p>Control module version</p>
  	<p>Factory reset</p> <p>When the word "rESEt" appears on the screen, this is the question to which the answer ("YES" or "no") is selected with the direction keys ▲ ▼ (TIME). The SAVE key  confirms the selection and restores the factory settings or returns to the Menu.</p>
  	<p>Rotor cycle counter</p> <p>It is the information to display the message "r.cYc. 500 ". The allowed number of cycles is 70000. The counter counts down from 70000 to 0.</p> <p>The counter can be reset by pressing the SAVE key .</p> <p>Pressing the direction keys ▲ ▼ (PROGRAM) changes the response to "rESEt YES" or "rESEt NO".</p> <p>Pressing SAVE  on the answers "rESEt YES" will return the counter to the value of 70000 cycles, and on "rESEt NO" will return to the display of the counter.</p>
	<p>Centrifuge cycle counter</p> <p>No allowed number of cycles defined; no message associated with this counter. The counter counts the cycles in ascending order from "0".</p> <p>It is not possible to reset the centrifuge cycle counter.</p>

<p>PROGRAM RPM/RCF x100 TIME COVER</p>	<p>Total spin time counter</p> <p>The first value displayed is expressed in hours. After pressing the arrows in the TIME section, the time will be displayed in minutes, which should be added to the display of full hours to obtain the total spin time.</p> <p>In the given example, it is 285h and 50min in total.</p>
<p>PROGRAM RPM/RCF x100 TIME COVER</p>	
<p>PROGRAM RPM/RCF x100 TIME COVER</p>	<p>PCB temperature measurement</p> <p>Temperature information on electronics.</p>
<p>PROGRAM RPM/RCF x100 TIME COVER</p>	<p>Measurement of the DC voltage supplying the inverter</p> <p>Information about voltage on electronics.</p>
<p>PROGRAM RPM/RCF x100 TIME COVER</p>	<p>Measure voltage proportional to the temperature of the inverter power module</p> <p>Information about voltage on electronics.</p>
<p>PROGRAM RPM/RCF x100 TIME COVER</p>	<p>Display and beeps test</p> <p>When you stop at this screen, all possible segments will be shown on both displays and an audible signal will sound to check if it is functioning properly.</p>

7. Centrifuging

7.1 Centrifuging with set time

Start centrifuging



After setting the appropriate spin parameters, described in the section **Control elements**, press

SAVE  and then **START** . The rotor will start to accelerate.

During acceleration, a dot is displayed next to the minutes value (it means waiting for the countdown to start), the symbol in the COVER field starts to spin.





After reaching the set rotational speed, the counter starts counting the time set for spinning. A countdown minute is displayed, along with a blinking dot which represents the seconds, when the last minute is exceeded, seconds are displayed without a dot. During centrifugation, the current value of RPM set for the test is displayed and the symbol in the COVER window is constantly spinning.



Braking

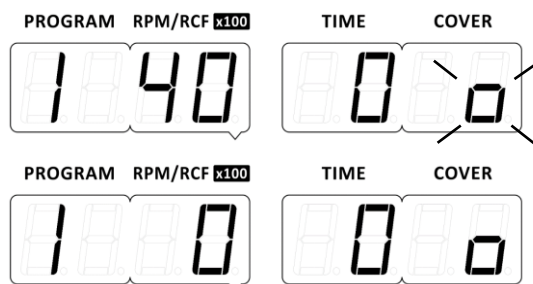

During braking, the rotor starts to brake after the time set for spinning has expired. During braking, the value in the Time field displays the time zero and the symbol flashes .

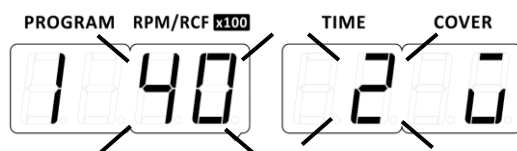

The stop of the rotor from the program is signaled by the simultaneous flashing of the **RPM / RCF** and **TIME** values. Flashing in the picture is marked by dashes deviating from the appropriate parameter. When the speed reaches zero, the lid is automatically opened (if so, set in the advanced options). The **COVER** field displays the symbol of an open cover – .



It is possible to centrifuge with an alternative unit to the centrifugal speed which is the relative centrifugal force RCF. The parameter change is described in section **Unit selection RPM / RCF**.

As in the case of centrifugation with the RPM unit, the centrifugation procedure with RCF parameter is analogous. After setting the appropriate spin parameters, referring to the previous sections of this manual, press the **SAVE** button  and then **START** button . The rotor will start to accelerate. The dot at the value in the RPM / RCF field informs us that the **RCF parameter is set**.

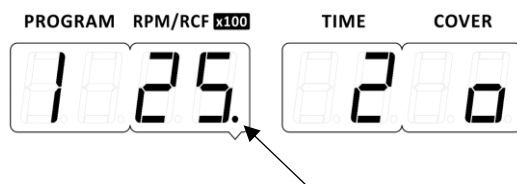



Stop centrifuging

STOP symbol -  displayed continuously means closed cover when rotor is stopped.

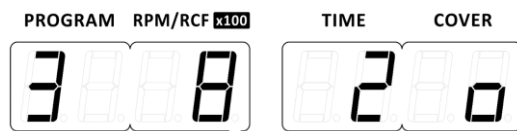
Example below: Third program with closed cover when rotor is stopped:



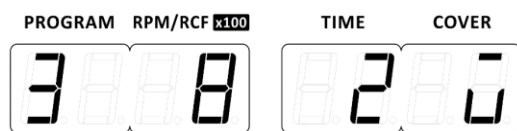

The cover is opened with the **STOP / COVER** button  after the rotor is completely stopped. The symbol  changes to the symbol for the lid open . Example of display below.



7.2 SHORT mode



SHORT mode is activated by pressing and holding the **START / SHORT** key . The difference between SHORT mode and normal operation is that in SHORT mode spinning lasts as long as the user holds the SHORT key. The spin parameters are set as needed, just like during a normal spin.

After pressing and holding the **START / SHORT** key , the centrifuge starts to accelerate, the revolutions from zero begin to increase until the set value is reached and the time in seconds begins to measure. The symbol  starts spinning (picture on the left). When the countdown timer approaches one minute, one minute appears with a blinking dot - seconds. After exceeding one minute, "2." appears, the next values are the next counted minutes (the centrifuge measures the seconds in the background - picture on the right).



7.3 Continuous spin mode (HOLD mode)

The centrifuge has the option of endless time centrifugation. A continuous spin mode - **HOLD** was created for this purpose. It works until the user interrupts it with the **STOP** button . To start centrifugation in the continuous spin mode, set the value in the **TIME** field to two dashes using the

direction keys   under the TIME field and then press the **START** key .

(If you want to save the program in HOLD mode, confirm with the **SAVE** button  before pressing **START**)



7.4 Cancel the centrifugation

If the **STOP** key  is pressed **once** during acceleration or proper centrifugation, the centrifuge will start to brake with the characteristics selected in options, the remaining time will be displayed (minutes without a dot).



Pressing the **STOP** key  **twice** during acceleration or proper spinning, the centrifuge will start to decelerate with the fastest possible characteristic.

Manually cancel the centrifugation causes that the lid does not open automatically (despite such a setting in advanced parameters) and is signaled by alternating blinking of **RPM / RCF** and **TIME** values. Flashing in the picture is marked with dashes deviating from the corresponding symbol.

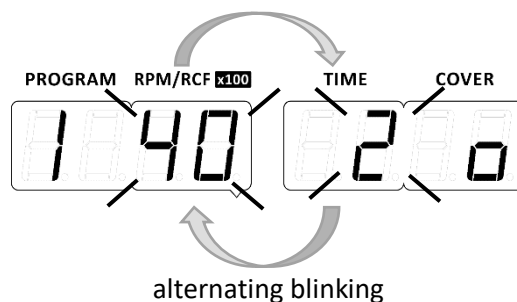

7.5 Changing parameters during centrifuging

During centrifugation, it is possible to change parameters **RPM**, **RCF** and **TIME**, but only when centrifuging from an **unsaved program**.

This is done by entering values with the direction arrows ▲▼. After each change, the centrifuge waits approx. 2 seconds for the next values. After the time has elapsed without pressing any key, the device starts to implement the change, which is signaled by the flashing of the changed values, when the sounds are turned off. On the other hand, when the sounds are turned on, the blink is accompanied by an acoustic signal played at the moment of the blink. Flashing in the picture is marked by dashes deviating from the appropriate parameter.

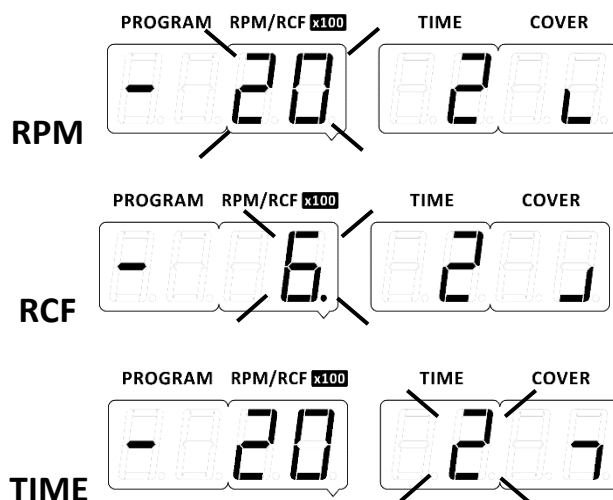

8. Service life, maintenance and chemical resistance

8.1 Service life of equipment

The rotor and containers have a lifetime of **70000 cycles** or **10 years**, whichever comes first.

After exceeding **69500** cycles (from 500 to 0 remaining cycles), each time the device is turned on, a message will be displayed informing about the number of remaining cycles, and additionally, every **50 cycles**, also before starting the centrifugation. When the rotor cycles have run out, the message will be displayed before each spin start.

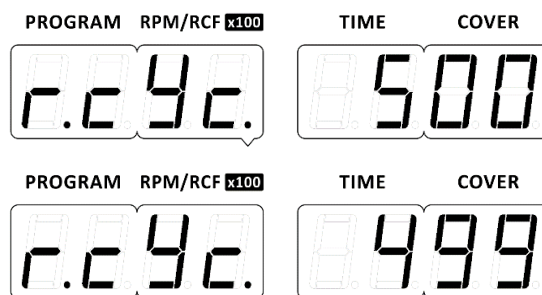

...

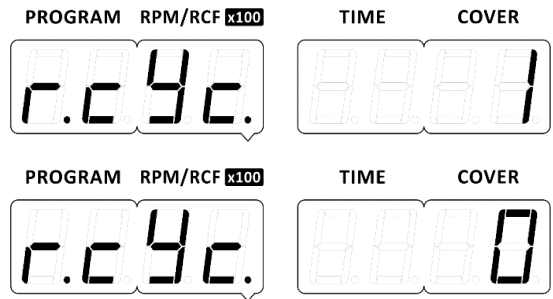

After exceeding 70000 rotor operation cycles (the value of 0 in "r.cYc." will appear) or **10 years** after the purchase of the device or the rotor with accessories, **it is absolutely necessary to replace the rotor and its accessories due to wear.**

After replacing the rotor and accessories with new ones, the "cYc" counter must be reset, referring to the description in the table under the item **Service menu**. The counter will again show the allowed number of cycles as below:

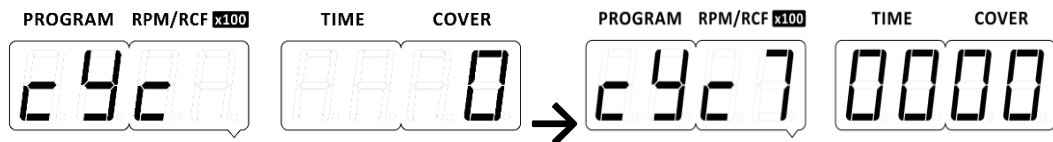

8.2 Maintenance of the centrifuge

Before any activities related to cleaning, maintenance or disinfection of the centrifuge, disconnect the centrifuge from the power supply.

Before using any cleaning, disinfection or maintenance procedures other than those recommended in the instruction manual, contact the manufacturer for information as to whether the procedure in question will not damage the device.

Use **water or other mild**, water-soluble cleaning agents for cleaning.

Aggressive and corrosive substances should be avoided. Do not use alkaline solutions, flammable solvents, or agents containing abrasive particles.

Do not lubricate the centrifuge motor shaft.

The unused centrifuge should be left with the lid open.



Once a day

- Remove water from the centrifugation chamber (water condensation due to temperature differences, or other liquids coming from test tubes) and dirt with a cloth.
- Do not allow any liquid to enter the housing.

Once a month

- Check the condition of the impeller clamp threads. In case of damage, it must be replaced.
- Check the condition of the centrifuging chamber, and in the event of damage being found, contact the authorized service representative of the manufacturer.

8.3 Maintenance of equipment

Cleaning of the equipment

	<p>The equipment must be maintained regularly to ensure safe operation.</p> <ul style="list-style-type: none"> ▪ Rotor, buckets and carriers are constantly subjected to high stresses resulting from the centrifugal force. Chemical reactions and corrosion can destroy metals from which the components of the centrifuge are made. Hard-to-see surface cracks may enlarge and weaken the material without visible symptoms. ▪ In the event of surface damage, crevice or other change, including corrosion, the part (rotor, container, etc.) must be replaced immediately. ▪ The rotor, including the clamp, buckets and round carriers must be regularly cleaned to prevent corrosion. ▪ The equipment should be cleaned outside the centrifuge once a week, and in case of visible dirt, immediately after use. To clean them, use neutral agents with a pH value in the range 6 ÷ 8. Alkaline agents with a pH value > 8 must not be used. Then these parts should be dried with a delicate cloth or in a chamber dryer at a temperature of about 50 ° C. ▪ Keeping the equipment clean significantly extends the operating time and reduces the susceptibility to corrosion. Accurate maintenance increases service life and prevents premature failure of the rotor. ▪ Minimize the time of immersion in each solution according to laboratory standards. ▪ Equipment made of metal (including aluminum) must be protected against corrosive substances. ▪ Corrosion and damage due to insufficient maintenance cannot be the basis of claims against the manufacturer.
---	---

8.4 Sterilization

Plastics – legend to abbreviations

PS	polystyrene	ECTFE	ethylene/chlorotrifluoroethylene
SAN	styrene-acrylonitrile	ETFE	ethylene/tetrafluoroethylene
PMMA	polymethyl methacrylate	PTFE	polytetrafluoroethylene
PC	polycarbonate	FEP	tetrafluoroethylene/perfluoro propylene
PVC	polyvinyl chloride	PFA	tetrafluoroethylene/perfluoroalkyl vinyl
POM	acetal polyoxymethylene	FKM	fluorocarbon rubber
PE-LD	low density polyethylene	EPDM	ethylene propylene diene
PE-HD	high density polyethylene	NR	natural rubber
PP	polypropylene	SI	silicon rubber
PMP	polymethyl pentene		

One can use all standard disinfectants. Centrifuges and devices are made of different materials, one should consider their variety.

	radiation β radiation γ 25 kGy	C ₂ H ₄ O (Ethylene oxide)	formalin, ethanol
PS	●	○	●
SAN	○	●	●
PMMA	●	○	●
PC	●	●	●
PVC	○	●	●
POM	●	●	●
PE-LD	●	●	●
PE-HD	●	●	●
PP	●	●	●
PMP	●	●	●
ECTFE, ETFE	○	●	●
PTFE	○	●	●
FEP, PFA	○	●	●
FKM	○	●	●
EPDM	○	●	●
NR	○	●	●
SI	○	●	●
●	can be used		
○	do not use		

In the centrifuge, disinfectants and cleaning agents generally used in medical care should be used (e.g., Aerodesina-2000, Lysoformin 3000, Melseptol, Melsept SF, Sanepidex, Cutasept F).

8.4.1 Autoclaving

- Rotors, buckets and round carriers can be sterilized in autoclave with temperature 121°C during 20 min (215 kPa), unless otherwise specified in the OPTIONAL ACCESSORY.
- During sterilization (autoclaved) by means of steam one should consider temperature resistance of individual materials.
- Deformation of the accessories (carriers or lids made of plastic) may occur during autoclaving.
- Do not autoclave disposable materials (e.g., tubes, cyto-container).
- The life of the accessory depends on the frequency of autoclaving and use.
- Autoclaving reduces lifespan of plastic and mechanical components. PC tubes can become useless.
- Pressure in closed containers can cause plastic deformation or explosion.
- Prior to autoclaving the rotors and accessories, thoroughly wash and rinse with distilled water.
- Never exceed the permissible autoclaving temperature and time.

Chemical resistance of plastics

	autoclaving 121 °C, 20 min		autoclaving 121 °C, 20 min
PS	○	PMP	●
SAN	○	ECTFE, ETFE	●
PMMA	○	PTFE	●
PC	●	FEP, PFA	●

PVC	○ ¹⁾	FKM	●
POM	●	EPDM	●
PE-LD	○	NR	○
PE-HD	○	SI	●
PP	●		
●	may be used		
○	cannot be used		
1)	except PVC hoses which are resistant to the steam sterilization in the temperature 121 °C.		

8.5 Chemical resistance

Chemical resistance of plastics

	aldehydes	cyclic alcohols	esters	ether	ketones	strong or concentrated acids	weak or diluted acids	oxidizing substances	cyclic hydrocarbons	ahs	haloid hydrocarbons	alkalis
PS	○	●	○	○	○	○/●	○/●	○	○	○	○	●
SAN	○	●	○	○	○	○	○/●	○	○	○	○	●
PMMA	○/●	●	○	○	○	○	○/●	○	○/●	○	○	○
PC	○/●	●	○	○	○	○	○/●	○	○/●	○	○	○
PVC	○	●	○	○	○	●	●	○	●	○	○	●
POM	○/●	●	○	●	●	○	○	○	●	●	●	●
PE-LD		●	●	●	○/●	●	●	○	●	●	●	●
PE-HD	●	●	○/●	○/●	○/●	●	●	○	●	○/●	○/●	●
PP	●	●	○/●	○/●	○/●	●	●	○	●	○/●	○/●	●
PMP	○/●	●	○/●		○/●	●	●	○	○/●	○	○	●
ECTFE, ETFE	●	●	●	●	○	●	●	●	●	●	●	●
PTFE, FEP, PFA	●	●	●	●	●	●	●	●	●	●	●	●
FKM	●	○	○	○	○	○	●	○/●	○/●	○/●	○/●	○/●
EPDM	●	●	○/●	○	○/●	●	●	○/●	○	○	○	●
NR	○/●	●	○/●	○	○	○	○/●	○	○	○	○	●
SI	○/●	●	○/●	○	○	○	○/●	○	○	○	○	○/●
●	very good	Permanent action of the substance for 30 days does not cause damage.										
○/●	good to limited	Continuous action of the substance causes insignificant and partly reversible damage through the period of 7-30 days (e.g., puffing up, softening, reduced mechanical durability, discoloring).										
○	limited	The material should not have the continuous contact with the substance. The immediate occurrence of damage is possible (e.g., the loss of mechanical durability, deformation, discoloring, bursting, and dissolving).										

Standard disinfectants can be used. Centrifuges and accessories are made of a variety of materials, the diversity of which should be considered.

Do not use chlorine bleach to clean the aluminum impellers.

	<p>Danger!</p> <p>To prevent infectious materials from getting inside the centrifuge, it is necessary to use biotight certified test tubes during centrifugation.</p>
---	--



In case of contamination of the rotating chamber or external elements of the centrifuge with hazardous materials, the user is obliged to disinfect it properly. Protective gloves must be worn during the above works.

9. Troubleshooting

9.1 Opening the cover after an error

If the rotor is stopped due to an error, the cover will not open automatically.

If the cover cannot be opened at all, make sure that the symbol  on the display is spinning,

and that after pressing the **STOP / COVER** key  it starts **blinking**. Wait for the rotor to stop and the symbol  to light up continuously.

If the cover still cannot be opened, refer to the section **Emergency opening the cover**.

9.2 Emergency cover release



EMERGENCY COVER RELEASE

Attention! *The cover may be opened in emergency only when the rotor is at rest. Before emergency opening the cover, switch off the mains power switch and disconnect the power cord. Wait 10 min and/or looking through the sight glass, make sure that the rotor is not rotating.*

It is possible to open the cover manually (e.g., in the event of a power failure). There is a plug on the right side, which must be unscrewed counterclockwise using the emergency lid release key (catalog number 18640). Then pull on the cap until the cover is open.

9.3 Unbalance

The centrifuge is equipped with a rotor unbalance sensor. If it is active, the spin process will be stopped by quick braking and an error message will be displayed as shown in the picture below. The symbol in the **COVER** field will be blinking (the blinking in the picture is marked with dashes deviating from the corresponding symbol), the sound signal will alarm the unbalance and the rotor will start to brake.

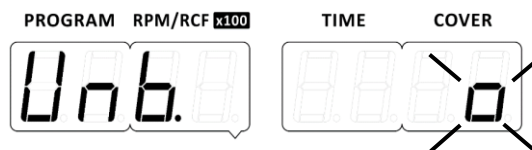

Erasing the error message is possible by pressing the **STOP** key after stopping the rotor. To restart the centrifugation, **it is necessary to open the cover** and make sure that the rotor has been properly loaded - places in the rotor must be equipped with identically filled containers, inserts, test tubes so as to obtain the best possible weight balance (see the section **Filling the rotor**).

Then close the cover and restart the spin cycle.









Unbalance causes noise, vibrations during operation and has a negative effect on the drive system (engine, shock absorbers). The more precisely the process of balancing the feed to the rotor is carried out, the smoother the centrifuge will run and the longer the useful life of the drive system will be. Moreover, an excellent level of separation of the swirl material is achieved, since the already separated components will not be picked up again by vibrations.

9.4 General errors

In the event of an error, messages regarding all errors will be displayed. The presentation method consists in displaying the inscription "Err." along with a numerical value. Error messages do not go out automatically and require user response.

Most errors can be cleared by switching the centrifuge off and on again. After switching the centrifuge on, the parameters of the last used program should appear.

In the event of a **short-term power failure**, the centrifuge completes the cycle with the shortest deceleration characteristic and then displays a power failure message.

Problem	Question	Answer
Centrifuge cannot be started	<i>Is the power cord connected properly?</i>	Connect the power cord.
	<i>Is the power socket switch on?</i>	Turn on the power.
Centrifuge does not start program (No reaction to the START button)	<i>Is the symbol  spinning on the screen?</i>	The spin cycle is running. Press the STOP key or wait for the cycle to end.
	<i>Is the symbol  blinking on the screen?</i>	Rotor brakes, wait for the rotor to stop (the symbol  stops blinking).
	<i>Is the symbol  displayed?</i>	Close the cover, the symbol  changes to  .

9.5 Error messages

The table below lists the possible errors that may occur during operation.

Error number	Error name	Cause	Symptoms	Error removal
Err. 01 or blank screen	No communication with the control panel	Damage to the cable connecting the control panel with the controller.	No response to keys	Reconnection of power or call for service
Err. 02	No signal from the RPM sensor	Mechanical blockage of the rotor, damage to the speed sensor or its cable, damage to the electronics, damage to the motor, the centrifuge may not be level, the centrifuge may not move during operation.	After starting the centrifugation cycle, no speed increase is shown on the display. Long beep	Power up again, open and close the lid, level the device, service repair
Err. 04	Engine overheating	It is created when the sensor detects too high a temperature.	Interruption of the spin cycle, engine shutdown. Coasting braking. Long beep	Reconnection of power or call for service
Err. 06	Exceeding the set speed	When the measured rotor speed is 500 rpm higher than the set speed in the normal cycle or the maximum speed in edit mode during the cycle	Emergency braking (very fast)	Reconnection of power or call for service
Err. 07	Emergency cover opening during spinning	After using the emergency lid release mechanism or in the event of a lock failure	Emergency braking (very fast)	Reconnection of power or call for service
Err. 08	Power failure during cycle	After temporarily turning the power off and on again during the spin cycle	Emergency braking (very fast)	Reconnection of power

10. Guarantee, repairs

The manufacturer provides the buyer with a warranty in accordance with the conditions specified in the warranty card. The buyer loses the right to a warranty repair if the device is not used in accordance with the instructions in the user manual or if it is damaged due to the user's fault.

Repairs of centrifuges should be performed in authorized services of MPW MED.INSTRUMENTS. The centrifuge for repairs should be delivered after disinfection with an attached decontamination declaration.

List of authorized services of MPW MED. INSTRUMENTS is available on the manufacturer's website - <https://mpw.pl/en/contact/contact-details>.

	<ul style="list-style-type: none">▪ The warranty period for the devices is 24 months (unless stated otherwise in the proof of purchase).▪ The warranty conditions are included in the warranty card.▪ The service life of the device is 10 years.▪ After 24 months from the beginning of the warranty period (date of purchase), the technical condition of the centrifuge should be inspected (validated) by the manufacturer's authorized service. Subsequent inspections should be carried out at annual intervals.▪ The permissible period of storage of an unused centrifuge is 1 year. After this period, it should be inspected by an authorized service center.▪ The producent reserves the right to make changes to the manufactured products.
---	--

11. Transport, storage, disposal

11.1 *Transport and storage*

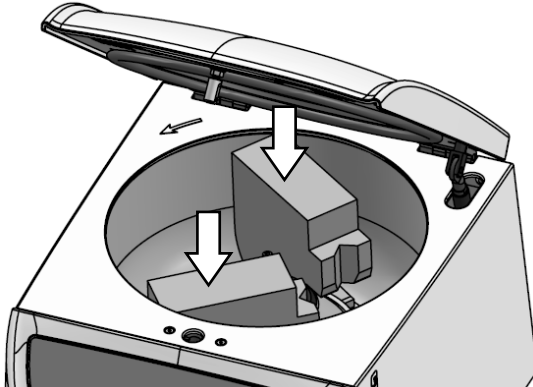
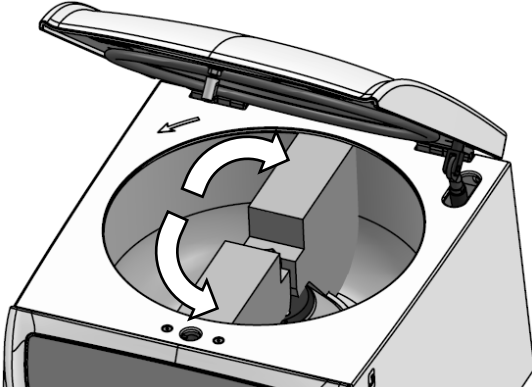

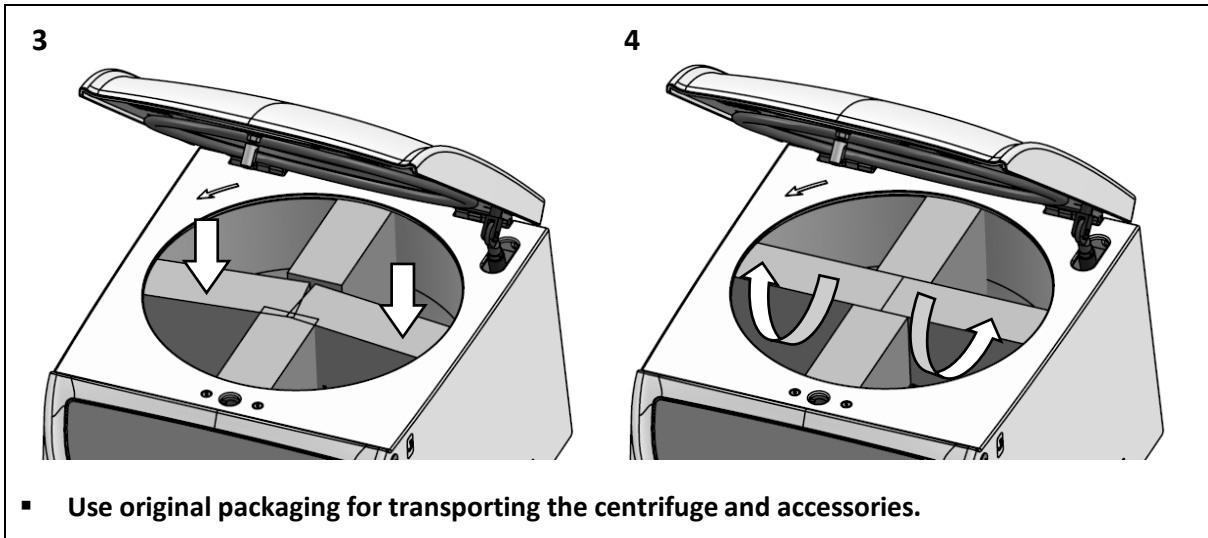
	<p>CAUTION! Due to the high weight of the device, lifting and carrying it may result in back injury. Use the appropriate number of people to lift and carry. Be assisted by a transport device.</p>
<ul style="list-style-type: none">▪ Only store the device in a closed and dry room.▪ Remove the rotor from the centrifuge before transport.▪ Secure the rotor shaft using original transport locks according to the following instructions. <div style="display: flex; justify-content: space-around;"><div data-bbox="252 1507 794 1944"><p>1</p></div><div data-bbox="850 1507 1393 1944"><p>2</p></div></div>	



11.2 Transport and storage conditions

	Storage (In the package)	Storage (Without the package)	Transport
Temperature	-25 ÷ +55 °C	-5 ÷ +45 °C	-25 ÷ +60 °C (general) -20 ÷ +55 °C (air)
Relative humidity	10 ÷ 75 %	10 ÷ 75 %	10 ÷ 75 %
Pressure	70 ÷ 106 kPa	70 ÷ 106 kPa	30 ÷ 106 kPa

11.3 Disposal

 	<p>When you are disposing the device, the respective statutory rules must be observed. Pursuant to guideline 2002/96/EC (WEEE).</p> <p>The device belongs to 8th group (medical devices) and is categorized in business-to-business field.</p> <p>The icon of the crossed-out trash can show that the device may not be disposed as part of domestic waste. The waste disposal guidelines of the individual EC countries might vary. If necessary, contact your supplier.</p>
--	---

12. Manufacturer's information

"MPW MED. INSTRUMENTS" SPÓŁDZIELNIA PRACY

Boremłowska 46 Street

04-347 Warsaw

tel. (+48) 22 610 56 67 (sales department - POLAND)
(+48) 22 879 70 46 (sales department - outside POLAND)
(+48) 22 610 81 07 (service)
fax: (+48) 22 610 55 36
e-mail: mpw@mpw.pl
website: www.mpw.pl

000042924 - entry number in the Waste Database Register

PL/CA01-01782 - identification number given by Office for Registration of Medicinal Products, Medical Devices and Biocidal Products.

Distributor's information

DISTRIBUTOR:

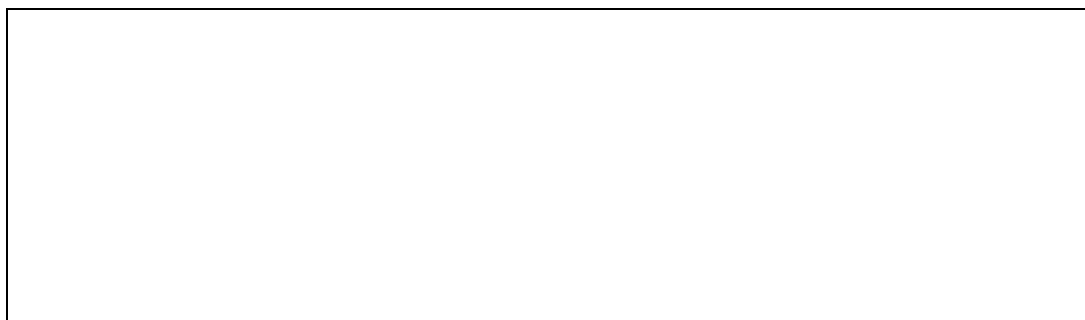

13. Annexes

A. Wyposażenie dodatkowe/Optional accessories**MPW M-BASIC****WIRNIK / ROTOR****PARAMETRY WIRNIKA / ROTOR PARAMETERS****POJEMNIK/BUCKET****WKŁADKA / ADAPTER**[liczba probówek na wirnik/tubes per rotor] **PROBÓWKA / TUBE****12815****RPM 4000, RCF 2469, Rmax 138, α 45/90****13815****14082**

[8]	*	BD Vacutainer® (13 x 100 mm), (4-7 ml)
[8]	*	Greiner Vacuette® (13 x 100 mm), (3,5-6 ml)
[8]	*	Sarstedt S-Monovette® (11 x 92 mm), (4,5; 5 ml)
[8]	*	Sarstedt S-Monovette® (13 x 90 mm), (4,9; 5,6 ml)
[8]	15119	7 ml probówka szklana (12 x 100 mm) 7 ml glass tube (12 x 100 mm)
[8]	*	BD Vacutainer® CPT™ (13 x 100 mm), (4 ml)
[8]	*	Sarstedt V-Monovette urine tube (round base) (13 x 100 mm)
bez wkładki/without adapter		
[8]	*	BD Vacutainer® (16 x 100 mm), (2,5-11 ml)
[8]	*	Greiner Vacuette® (16 x 100 mm), (7-9 ml)
[8]	*	Sarstedt S-Monovette® (15 x 92 mm), (7,5; 8,2; 8,5 ml)
[8]	*	Sarstedt S-Monovette® (16 x 92 mm), (9; 10 ml)
[8]	15046	14 ml probówka z pokrywką (16,8 x 113,7 mm), Sarstedt® 14 ml tube with cap (16,8 x 113,7 mm), Sarstedt®
[8]	15048	15 ml Thermo Nalgene® (16 x 113 mm) 15 ml Thermo Nalgene® (16 x 113 mm)
[8]	15053	10 ml probówka z pokrywką (16 x 106 mm) 10 ml tube with cap (16 x 106 mm)
[8]	15118	10 ml probówka szklana (16 x 100 mm) 10 ml glass tube (16 x 100 mm)
[8]	*	15 ml probówka z dnem stożkowym z zakrętką (17 x 120 mm), Falcon®; [15050], 15ml (17 x 120 mm) 15 ml tube, conical bottom, with cap (17 x 120 mm), Falcon®; [15050] 15ml Sarstedt®(17 x 120 mm)
[8]	*	BD Vacutainer® CPT™ (16 x 125 mm), (8 ml)
[8]	*	Greiner Vacuette® Urine culture (16 x 100 mm), (9,5 ml)
[8]	*	Sarstedt V-Monovette urine tube (round base) (15 x 100 mm)
[8]	*	Sarstedt V-Monovette urine tube (conical base) (15 x 100 mm)
[8]	*	BD urine tube (16 x 100 mm)
[8]	*	Medlab 35-1205-0P (16x105), (12ml)
[8]	*	Medlab 35-1210-0 (16x105), (10ml)
[8]	*	Medlab 35-1210-0P (16x105), (12ml)
[8]	*	TPP conical tube (17 x 120 mm), (15 ml)
[8]	*	TPP round bottom, tissue culture tube (16 x 120 mm), (5-8 ml)
[8]	*	Mini Parasep®SF
14815		
[8]	*	Sarstedt S-Monovette® (15 x 75 mm), (4; 4,3; 5,5 ml)

* probówka niedostępna w ofercie MPW lub dostępny odpowiednik (np:[15050]), patrz kolumna z prawej
tube is not offered by MPW or equivalent is available (e.g. [15050]), see column on the right

A. Wyposażenie dodatkowe/Optional accessories**MPW M-BASIC**

- [8] * 10 ml Thermo Nalgene® Oak Ridge (16 x 81,5 mm)
[8] 15121 10 ml probówka z dnem okrągłym i pokrywką (17 x 70 mm)
10 ml tube, round bottom, with cap (17 x 70 mm)

14082+14815

- [8] * BD Vacutainer® (13 x 75 mm), (1,6-5,3 ml)
[8] * Greiner Vacuette® (13 x 75 mm), (1-4,5 ml)
[8] * Sarstedt S-Monovette® (11 x 66 mm), (1,6; 2; 2,7; 3; 3,1 ml)
[8] * Sarstedt S-Monovette® (13 x 65 mm), (2,6; 2,9; 3,4; 3,8 ml)
[8] * Sarstedt S-Monovette® (13 x 75 mm), (2,7; 3; 4,3 ml)
[8] 15054 6 ml probówka z pokrywką (11,5 x 92 mm), Sarstedt®
6 ml tube with cap (11,5 x 92 mm), Sarstedt®
[8] 15120 5 ml probówka szklana (12 x 75 mm)
5 ml glass tube (12 x 75 mm)
[8] 15419 5 ml probówka z korkiem (12 x 85 mm), Sarstedt®
5 ml tube with cap (12 x 85 mm), Sarstedt®
[8] * Sarstedt V-Monovette urine tube (13 x 75 mm)
[8] * BD urine tube (13 x 75 mm)

RPM 4000, RCF 2290, Rmax 128, 4 45/90**13816****14817+14818**

- [2] * 50 ml probówka z dnem stożkowym z zakrętką (30 x 117 mm), Falcon®; [15052] 50ml (30 x 117mm)
50 ml tube, conical bottom, with cap (30 x 117 mm), Falcon®; [15052] 50ml Sarstedt® (30 x 117 mm)
[2] * 50 ml probówka z dnem stożkowym bez rantu (30 x 115 mm), Greiner®
50 ml tube, conical bottom, without skirt (30 x 115 mm), Greiner®

14820

- [2] * 15 ml probówka z dnem stożkowym z zakrętką (17 x 120 mm), Falcon®; [15050], 15ml (17 x 120 mm)
15 ml tube, conical bottom, with cap (17 x 120 mm), Falcon®; [15050] 15ml Sarstedt®(17 x 120 mm)

14817

- [2] * 50 ml probówka z dnem stożkowym z rantem (30 x 115 mm), Greiner®
50 ml tube, conical bottom, skirted (30 x 115 mm), Greiner®

RPM 4000, RCF 2290, Rmax 128, 4 90**13816****bez wkładki/without adapter**

- [2] * Prolo 30

14817+14816

- [2] * Dr. PRP
[2] * Xerthra 15ml
[2] * Xerthra 20ml

14816

- [2] * Xerthra 30/60ml

Suma końcowa

DECLARATION OF CONFORMITY

Product name: **Laboratory centrifuge
MPW M-BASIC**

Product type: **Laboratory centrifuge**

This declaration of conformity is issued under the sole responsibility of the manufacturer.

Product classification on the basis of the Directive 98/79/EC: **Non classified to list A or B and not for self-testing.**

Product complies with the requirements:

• **Directive 98/79/EC (IVD), including the requirements of harmonized standards:**

EN 15223-1:2016

EN ISO 18113-3:2011

EN 13612:2002

EN 61326-2-6:2006

EN 13612:2002/AC:2002

EN 61010-2-101:2002

EN 13975:2003

EN 62304:2006

EN ISO 14971:2012

EN 62304:2006/AC:2008

EN ISO 18113-1:2011

EN 62366:2008

• **selected harmonized standards of Directive 2014/35/UE (LVD):**

EN 61010-1:2010

EN 61010-2-020:2006

EN 61010-1:2010/A1:2019

EN 61010-1:2010/A1:2019/AC:2019-04

• **Directive 2014/30/UE (EMC)**

• **Directive 2011/65/UE (RoHS 2)**

"MPW MED. INSTRUMENTS"

SPÓŁDZIELNIA PRACY

Warsaw, 46 Boremlowska Street

applies Quality Management System in line with

PN-EN ISO 9001:2015, PN-EN ISO 13485:2016

PREZESA ZARZĄDU

Wojciech Anisiewicz



PREZES ZARZĄDU

mgr Łukasz Szański



ISO 9001



ISO 13485

DECLARATION OF DECONTAMINATION

(repair)

In order to protect our employees please fill out the declaration of decontamination completely before sending centrifuge to the manufacturer (repair).

1. Device:

– type:

– serial No.:

2. Description of decontamination

(see user manual)

.....

.....

.....

.....

3. Decontamination carried out by:

name:

4. Date and signature:

.....

DECLARATION OF DECONTAMINATION

(return)

In order to protect our employees please fill out the declaration of decontamination completely before sending centrifuge to the manufacturer (return).

1. Device:

– type:

– serial No.:

2. Description of decontamination

(see user manual)

.....

.....

.....

.....

3. Decontamination carried out by:

name:

4. Date and signature:

.....

NOMOGRAM

Centrifuging radius [cm]

R.C.F. (x "g")
multiple of
gravitational
acceleration

[r.p.m.]

