

# USER MANUAL



**Laboratory centrifuge MPW-352**  
**Refrigerated laboratory centrifuge MPW-352R**  
**Refrigerated and heated laboratory centrifuge MPW-352RH**

**Read before use!**

Serial number of the centrifuge: .....





For centrifuges with serial no (SN): MPW-352: from 10352085519  
MPW-352R: from 10352R066719  
MPW-352RH: from 10352RH010019

This manual was prepared with special care. MPW MED. INSTRUMENTS may change the manual at any time and without notice because of improvements, typographical errors or improvements to facilities  
All rights reserved. No part of this User Manual may be modified, distributed, published or reproduced without the prior permission of MPW MED. INSTRUMENTS.

You can find the current version of the user manual on our website under:

**www.mpw.pl DOWNLOAD** section (one should choose demanded language version of website).

**Warning signs:**

	<b>WARNING!</b> Warning of potential injury or health risk.
	<b>DANGER!</b> Risk of electric shock with potential for severe injury or death as a consequence.
	<b>DANGER!</b> Biohazard with potential for risk to health or death as a consequence.
	<b>DANGER!</b> Risk of explosion with potential for severe injury or death as a consequence.

# Content

<b>1 APPLICATION</b> .....	<b>5</b>
<b>2 TECHNICAL SPECIFICATION</b> .....	<b>6</b>
<b>3 INSTALLATION</b> .....	<b>7</b>
3.1 CONTENT OF THE PACKAGE .....	7
3.2 LOCATION .....	7
3.3 CURRENT PROTECTION .....	8
<b>4 SAFETY NOTES</b> .....	<b>9</b>
4.1 OPERATING PERSONNEL .....	9
4.2 LOADING THE ROTOR .....	10
4.3 SAFETY HINTS .....	11
4.4 MAINTENANCE CONDITIONS .....	12
4.5 UNBALANCE .....	14
4.6 RESIDUAL RISK .....	14
<b>5 OPERATING</b> .....	<b>15</b>
5.1 CENTRIFUGE OVERVIEW .....	15
5.2 CENTRIFUGE DESCRIPTION .....	15
5.3 CONSTRUCTION .....	16
5.4 NAME PLATE .....	16
5.5 ROTOR AND ACCESSORIES INSTALLATION .....	16
5.6 CONTROL DEVICE .....	17
5.7 SETTING PARAMETERS .....	18
5.8 SAFETY FEATURES .....	18
5.9 INCREASE IN TEMPERATURE (MPW-352 ONLY) .....	18
<b>6 CENTRIFUGING</b> .....	<b>19</b>
6.1 CONTROL PANEL .....	19
6.2 DISPLAY .....	20
6.3 <b>SETTING UP RPM, RCF, TIME, TEMPERATURE</b> .....	21
6.4 <b>USERS PROGRAMS</b> .....	23
6.5 PROGRAMS WITH USER CHARACTERISTICS .....	29
6.6 <b>ROTOR CHOOSING</b> .....	29
6.7 <b>SHORT MODE</b> .....	30
6.8 <b>FINISHING THE CENTRIFUGING</b> .....	30
6.9 TEMPORARILY DISABLED FUNCTIONS .....	31
<b>7 TEMPERATURE CONTROL</b> .....	<b>32</b>
7.1 INITIAL COOLING DURING CENTRIFUGING –FAST COOL .....	32
7.2 INITIAL COOLING OR HEATING WITHOUT CENTRIFUGING – THERMAL CHAMBER .....	33
7.3 COOLING OR HEATING IN “START DELAY – OF TEMPERATURE” MODE .....	33
7.4 COOLING OR HEATING IN „SHORT” MODE .....	33
7.5 COOLING AND HEATING NOTES .....	33
<b>8 PARAMETERS OF CENTRIFUGATION</b> .....	<b>34</b>
8.1 ACCELERATION/DECELERATION – CHANGING CHARACTERISTICS .....	35
8.2 RADIUS .....	35
8.3 SAMPLE DENSITY .....	35
8.4 <b>TEMPERATURE OFFSET</b> .....	36
8.5 THERMAL CHAMBER .....	37
8.6 AUTOMATIC LID OPENING .....	38
8.7 START DELAY - OF TIME .....	38
8.8 START DELAY – OF TEMPERATURE .....	39
8.9 PRINTING REPORT (USB) .....	39
<b>9 MENU</b> .....	<b>46</b>

9.1	SCREEN SAVER.....	47
9.2	VISUAL ALARM .....	47
9.3	TYPES OF MAIN SCREEN.....	47
9.4	ROTATING RUNTIME .....	49
9.5	BUZZER .....	49
9.6	DATE/TIME.....	49
9.7	LANGUAGE .....	50
9.8	OTHER .....	50
9.9	PASSWORD.....	51
9.10	LAST 10 CYCLES .....	53
9.11	WORK TIME .....	53
9.12	ROTOR RUNTIME.....	53
9.13	CONTACT US .....	54
9.14	DIAGNOSTICS .....	54
9.15	FACTORY SETTINGS .....	54
<b>10</b>	<b>MAINTENANCE.....</b>	<b>55</b>
10.1	CLEANING OF THE CENTRIFUGE .....	55
10.2	MAINTENANCE OF CENTRIFUGE ELEMENTS.....	55
10.3	STERILIZATION .....	57
10.4	CHEMICAL RESISTANCE .....	59
<b>11</b>	<b>TROUBLESHOOTING .....</b>	<b>60</b>
11.1	MESSAGES .....	61
11.2	EMERGENCY COVER RELEASE .....	62
<b>12</b>	<b>GUARANTEE .....</b>	<b>63</b>
<b>13</b>	<b>DISPOSAL .....</b>	<b>64</b>
<b>14</b>	<b>MANUFACTURER'S INFO .....</b>	<b>65</b>
	<b>DISTRIBUTOR'S INFO .....</b>	<b>65</b>
<b>15</b>	<b>ANNEXES.....</b>	<b>66</b>

- A. ADDITIONAL ACCESSORIES
- B. DECLARATION OF CONFORMITY CE
- C. DECLARATION OF CONFORMITY ROHS 2
- D. DECLARATION OF DECONTAMINATION (repair / return)
- E. NOMOGRAM RPM / RCF

# 1 Application

The MPW-352/R/RH centrifuges are table top laboratory centrifuge for in vitro diagnostic (IVD). Devices are used for separation samples taken from people's, animal's and plant's components of different densities, under the influence of the centrifugal force, to provide information about their biological state (MPW-352 – ventilated, MPW-352R – with cooling, MPW-352RH – with cooling and heating).

Its construction ensures easy operation, safe work and wide range of applications at laboratories engaged in routine medical analyses, biochemical research works etc.

In the centrifuge, it is prohibited to centrifuge caustic, inflammable and explosive preparations.

## 2 Technical specification

manufacturer	"MPW MED. INSTRUMENTS" SPÓŁDZIELNIA PRACY, Boremlowska 46 Street, 04-347 Warsaw									
type	<b>MPW - 352</b>					<b>MPW - 352R/RH</b>				
mains voltage (L1+N+PE)	230V	100V	110V	120V	127V	230V	100V	110V	120V	127V
	±10%		±5%			±10%		±5%		
mains frequency,	50/60Hz	50Hz/60Hz			50Hz	60Hz	60Hz			
power consumption (max.)	600W					980W				
current protection [A]	T 6,3A	T 10A			T 10A		T 16A			
cooling medium	-					R452A (CFC/HCFC free)				
	<b>MPW - 352</b>					<b>MPW - 352R</b>		<b>MPW - 352RH</b>		
capacity (max.)	1000 ml									
speed – RPM	90 ÷ 18000 rpm (step 1 rpm)									
force – RCF	29703 x g (step 1 x g)					30065 x g (step 1 x g)				
kinetic energy (max.)	19148 Nm									
running time	00:00:01 ÷ 99:59:59 – [hours, min., sec] (step 1s)									
time counting	since start button is pressed / since preselected speed is reached									
short-time operation mode – SHORT	yes									
continuous operation mode – HOLD	yes									
user programs	100									
adjustable temperature	-					-20 ÷ 40°C* (step 1°C)		-20 ÷ 55°C* (step 1°C)		
initial cooling/heating PROG 99 (90 ÷ 2500 RPM)	no/ no					yes / no		yes / yes		
guaranteed temperature with max. rotor speed	-					≤4°C				
cooling/heating without centrifuging	no					yes/ no		yes / yes		
cooling/heating with centrifuging	no					yes /no		yes / yes		
acceleration (ACEL)	10 linear curves									
deceleration (DECEL)	10 linear curves									
programmable non-linear curves:										
acceleration	10									
deceleration	10									
USB communication	yes									
Electromagnetic compatibility	according to PN-EN 61326-1:2006									
ambient conditions	PN-EN 61010-1 (p.1.4.1)									
set-up site	indoors only									
ambient temperature	2° ÷ 40°C									
humidity (maximum relative humidity)	< 80%									
installation category	II					EN 61010-1				
pollution degree	2					EN 61010-1				
safety area	300 mm									
degree of protection	IP21			IP20				IP20		
height (H)	380 mm					380 mm				
width (W)	443 mm					443 mm				
depth (D)	545 mm					695 mm				
height with open cover (H <sub>oc</sub> )	768 mm					768 mm				
noise level	<65 dB									
weight 230V	41,8 kg					64,8 kg		65,7 kg		
weight 120V	45 kg					70,9 kg		71,8 kg		

\*time and possibility of obtaining a set temperature is dependent on multiple factors , including: rotor type, established RPM, ambient temperature; accuracy: ±1°C (for 352R), ±3°C (for 352RH) appropriate for place of temperature sensor

Menu languages: POLISH, ENGLISH, GERMAN, SPANISH, ITALIAN, PORTUGUESE, RUSSIAN, SWEDISH, FRENCH, CZECH.


### 3 Installation

Open the package. Remove the box containing the accessories. Take out centrifuge from the container. Keep the box and packing materials in case of service shipping.


#### 3.1 Content of the package

name	pcs.	cat no. (REF)
centrifuge MPW-352/R/RH	1	10352/2-56 10352/1-56 10352R/2-5 10352R/1-6 10352R/2-6 10352RH/2-5 10352RH/1-6 10352RH/2-6 (type and supply version dependent)
complete clamp	1	17664
spanner for the rotor	1	17665
spanner for emergency opening of the cover	1	17162
power cord 230V / 120V	1	17866/17867
fuse WTA T 6,3A 250V / WTA T10A 250V /WTA T16A 250V	2	17862/17863/17864
Vaseline 20ml	1	17201
USB A-A cable	1	16655
user manual	1	20352/R/RH.EN rev.10


#### 3.2 Location

	<ul style="list-style-type: none"> <li>▪ Ensure safe location.</li> <li>▪ The centrifuge shall not be located near source of heat and shall not be subjected to direct sunlight.</li> <li>▪ Centrifuge should be flat-levelled. Effect of leveling shall be ensure by stable and flat-levelled table top for the centrifuge.</li> <li>▪ Centrifuge should be set horizontally on a rigid base.</li> <li>▪ It is necessary to ensure a ventilation zone of the minimum 30cm round the centrifuge from every direction. Do not veil ventilation holes !</li> <li>▪ Table for centrifuge should posses safety zone of the minimum 30cm round the centrifuge from every direction (safety needs in case of malfunction according to EN 61010-020).</li> <li>▪ Table for centrifuge should be free of containments before locating of centrifuge.</li> <li>▪ Passed parameters of the centrifuge are referring to the above named temperatures (see 2.Technical specification).</li> <li>▪ At the change of the place from cold to warm one, condensation of water will</li> </ul>
---	---

	<p>occur inside the centrifuge. It is important then that sufficient time be provided for drying the centrifuge prior to starting the centrifuge again (min. 4 hours).</p> <ul style="list-style-type: none"> <li>▪ Do not position the centrifuge so that it is difficult to operate the power switch.</li> <li>▪ Supply voltage given on the name plate has to be consistent with local supply voltage. MPW MED INSTRUMENTS laboratory centrifuges are 1st safety class devices and they are provided with the three-core cable with the plug resistant to dynamic loadings. Mains socket have to be provided with the safety pin (protective earth (PE)).</li> <li>▪ It is recommended to install emergency cut-out that shall be located far from the centrifuge, near the exit or beyond the room.</li> </ul>
--	--

	<ul style="list-style-type: none"> <li>▪ <b>Before switching on, check whether the centrifuge is connected to power supply correctly. It is obligatory to use only power cord recommended by manufacturer (17866 for 230V, 17867 for 120V)</b></li> </ul>
---	---


### 3.3 *Current protection*

	<p>The centrifuge is equipped with thermal current protection. Fuse is situated in the plug-in socket unit at back wall of the centrifuge.</p>
---	--



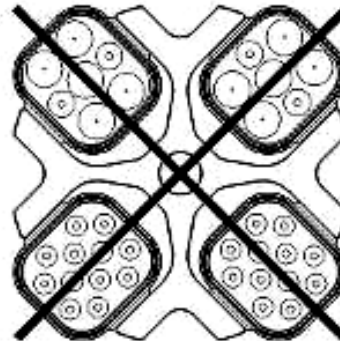
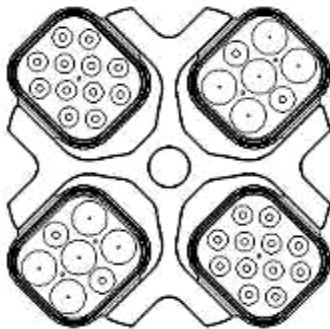
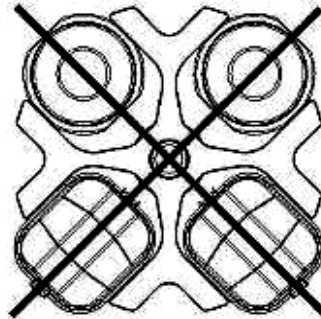
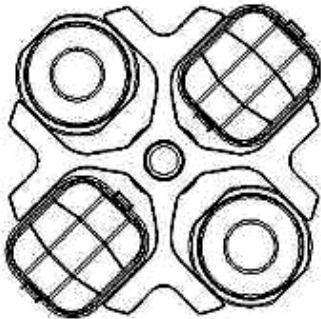
## 4 Safety notes

### 4.1 *Operating personnel*

	<ul style="list-style-type: none"><li>▪ Laboratory centrifuge can be operated by laboratory personnel after getting acquainted with user manual.</li><li>▪ <b>This User Manual is part of the device.</b></li><li>▪ <b>User manual shall be always held near the centrifuge.</b></li><li>▪ The centrifuge can not be misused.</li><li>▪ If the centrifuge is used in a manner not specified by the manufacturer, the protection provided by the device may be impaired.</li></ul>
---	---

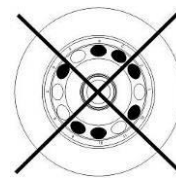
## 4.2 Loading the rotor

- Fix the rotor on the motor axis firmly.
- Avoid unbalance.
- Load opposite buckets with the same accessories.
- Centrifugation of the test tubes of different sizes:
  - There is a possibility to centrifuge test tubes of different sizes; however, it is absolutely necessary in such cases that opposite buckets and round carriers be the same.
  - Mass of different containers with test tubes spun at the same time has to be comparable. Swing-out rotors must be equipped with all ( two or four – dependent to type of rotor) buckets.
- Lubricate the swing-out rotor journal pins.



**CORRECT**


**WRONG**







**CORRECT**

**WRONG**




- It is necessary to insert test tubes symmetrically on the opposite sides.




	<p><b>FILLING TUBES</b></p> <ul style="list-style-type: none"> <li>▪ Fill test tubes outside the centrifuge.</li> <li>▪ Please pay special attention to the quality and proper thickness of the glass test tubes walls. Those shall be test tubes for centrifuges.</li> <li>▪ Fill test tubes outside the centrifuge.</li> </ul>
---	--


### 4.3 Safety hints


	<p><b>ROTORS MAINTENANCE</b></p> <ul style="list-style-type: none"> <li>▪ Lubricate the swing-out rotor journal pins.</li> <li>▪ Use only accessories in good condition.</li> <li>▪ Protect equipment against corrosion using accurate preventive maintenance.</li> </ul>
	<p><b>HS ACCESSORIES MAINTENANCE</b></p> <ul style="list-style-type: none"> <li>▪ Make sure that rubber O-rings are lightly coated with silicone grease. Use high vacuum grease, e.g. type „C” by LUBRINA.</li> </ul>
	<p><b>HAZARDOUS MATERIALS</b></p> <ul style="list-style-type: none"> <li>▪ MPW accessories are not biotight. For centrifuging infectious materials it is necessary to use hermetically closed tubes meeting demands of biotightness, in order to prevent germs migration into the centrifuge and beyond it.</li> <li>▪ It is not allowed to subject to centrifugation toxic or infectious materials with damaged leak proof seals of the rotor or test-tube. Proper disinfection procedures have to be carried out when dangerous substances contaminated the centrifuge or its accessories.</li> </ul>
	<p><b>EXPLOSIVE AND COMBUSTIBLE MATERIALS</b></p> <ul style="list-style-type: none"> <li>▪ It is not allowed to centrifuge explosive and inflammable materials.</li> <li>▪ It is not allowed to centrifuge substances prone to reacting in result of supplying high energy during centrifugation. The centrifuge can not be operated in explosion-endangered areas.</li> <li>▪ It is not allowed to centrifuge materials capable of generating inflammable or explosive mixtures when subjected to air.</li> </ul>


#### 4.4 Maintenance conditions

	<p><b>START-UP</b></p> <ul style="list-style-type: none"> <li>▪ Prior to switching the centrifuge on, one shall read carefully all sections of this user manual in order to ensure smooth operation and avoid damages of this device or its accessories.</li> <li>▪ In order to protect the centrifuge against unbalance, fill in the test tubes up to the same weight.</li> </ul>
	<p><b>TRANSPORTATION</b></p> <ul style="list-style-type: none"> <li>▪ Centrifuge must not be transported with the rotor mounted on the shaft..</li> </ul>
	<p><b>GENERAL HINTS</b></p> <ul style="list-style-type: none"> <li>▪ One must use original rotors, tubes and spare parts only.</li> <li>▪ In case of faulty operation of the centrifuge one shall ask for assistance of service of MPW MED. INSTRUMENTS company or its authorized representatives.</li> <li>▪ It is not allowed to switch the centrifuge on if it is not installed properly or rotor is not fitted correctly.</li> </ul>

	<p><b>CENTRIFUGES SUBSTANCES</b></p> <ul style="list-style-type: none"> <li>▪ It isn't allowed to exceed load limit set by the manufacturer. Rotors are intended for fluids of average homogeneous density equal to <b>1,2 g/cm<sup>3</sup></b> or smaller when centrifugation is carried out at maximum speed. When fluids of higher density shall be used, then it is necessary to change density of centrifuges sample in <b>PARAM/DENSITY</b> field.</li> <li>▪ Observe the limitation on the permissible mass specified on the rotor/ bucket (eg. MAX 15g). If the designation is given on the rotor, it refers to the mass of the sample. If the designation is given on the bucket, it refers to the mass of the entire load, i.e. adapter+ tube + sample.</li> </ul> <p><b>Examples:</b></p> <div style="display: flex; justify-content: space-around; align-items: flex-start;"> <div style="text-align: center;"> <p><b>Rotor</b></p>  <p><b>2,4g</b> – maximal mass of tube content</p> </div> <div style="text-align: center;"> <p><b>Bucket</b></p>  <p><b>290g</b> – maximal mass of elements inside bucket</p> </div> </div>
---	--

	<p style="text-align: center;"><b>INSPECTION PROCEDURES CARRIED OUT BY THE OPERATOR</b></p> <p>Operator has to pay special attention to the fact that the centrifuge parts of key importance due to safety reasons are not damaged. This remark is specifically important as for:</p> <ul style="list-style-type: none"> <li>▪ Centrifuge accessories and especially structural changes, corrosion, preliminary cracks, abrasion of metal parts.</li> <li>▪ Screw connections.</li> <li>▪ Inspection of seals of the buckets if such are used. Special attention must be paid to all of the rubber (seals) parts. In the case of damage or visible structural changes defective parts must be replaced for new immediately (Set of seals Cat. No. 18591 available from the manufacturer).</li> <li>▪ Control of execution of the guarantee yearly technical inspection of the centrifuge (after lapse of guarantee).</li> <li>▪ Only the manufacturer-specified buckets, included in the equipment list, as well as centrifuge tubes, which diameter, length and durability are suitable, should be used for spinning in this centrifuge. The use of equipment made by other manufacturers should be consulted with the manufacturer of the centrifuge.</li> <li>▪ It is not allowed to lift or shift the centrifuge during operation, and rest on it.</li> <li>▪ It is nor allowed to stay in the safety zone within 30 cm distance around the centrifuge neither leave within this zone some things, e.g. glass vessels.</li> <li>▪ It is not allowed to put any objects on the centrifuge</li> </ul>
---	---

	<p><b>COVER OPENING</b></p>
	<ul style="list-style-type: none"> <li>▪ It is not allowed to open the cover manually in emergency procedure when rotor is still turning.</li> </ul>


	<b>ROTORS</b>
	<ul style="list-style-type: none"> <li>▪ It is not allowed to use the rotors and round carriers with signs of corrosion or other mechanical defects.</li> <li>▪ It is not allowed to centrifuge highly corrosive substances which may cause material impairment and lower mechanical properties of rotor and round carriers.</li> <li>▪ It is not allowed to use rotors and accessories not admitted by the manufacturer. Let to use commercial glass and plastic test tubes, which are destined to centrifuging in this laboratory centrifuge. One should absolutely not use poor quality elements. Cracking of glass vessels and test tubes could result in dangerous vibration of the centrifuge.</li> <li>▪ It is not allowed to carry out centrifugation with the rotor caps taken off or not driven tight.</li> </ul>

#### 4.5 *Unbalance*

The centrifuge is provided with the rotor unbalance sensor and when it will be activated, centrifugation process will be stopped through fast braking and at the same time an error message will be displayed. Cancellation of this error is possible only through pressing **BACK** key after stopping of the rotor.

One must check if rotor was correctly loaded, close the cover and once more start the program. In order to protect the rotor against improper work, it has to be provided with identically filled buckets, carriers, test-tubes etc. for getting the best balance possible (see section 4.3).

Then close the cover and restart the program.

	<p>Unbalance causes noise and vibrations during operation, and adversely affects power transmission system (motor, shock absorbers). The better balance, the smoother will be the centrifuge operation and therefore longer life of usage of the driveline. Moreover, the ideal separation level is then obtained, as already separated constituents would not be moved up by vibration.</p>
---	--

#### Emergency stop

In any moment of centrifuging it is possible interrupt the process and fast stop the rotor. Single-time pressing of the **STOP** key will make centrifuging stop with acceleration characteristics set in the program (after pressing the **SET** or **STOP** key, the device returns to the main screen). Pressing and holding it up to 1s will make the centrifuging stop with the most strict characteristic.

#### 4.6 *Residual risk*

The centrifuge is built according to the state-of-the-art and the recognized safety regulations. Nevertheless, still remain some level of residual risk due to improper operation and malfunctions. It is possible to decrease residual risk by strictly applying user manual conditions and correcting malfunction which could threaten safety, immediately.

# 5 Operating

## 5.1 Centrifuge overview

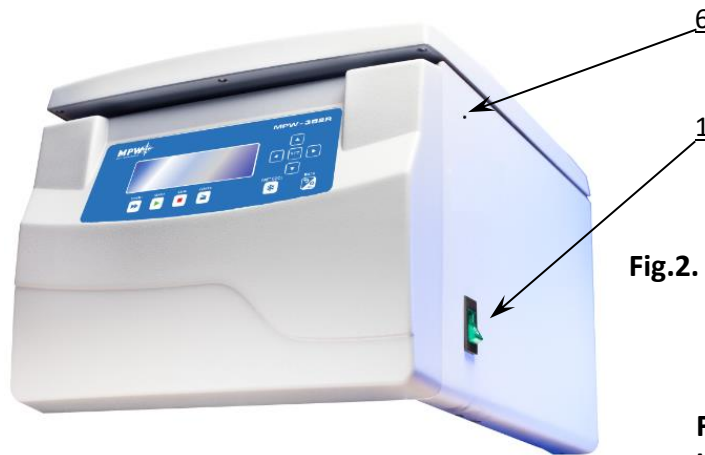
New generation of MPW MED. INSTRUMENTS laboratory centrifuges is provided with state-of-the-art microprocessor control systems, very durable and quiet asynchronous brushless motors and accessories consistent with requirements of the present-day user.

## 5.2 Centrifuge description

- 1. Power switch
- 2. USB
- 3. Control panel
- 4. Cover
- 5. Inspection glass
- 6. Point of emergency lid opening

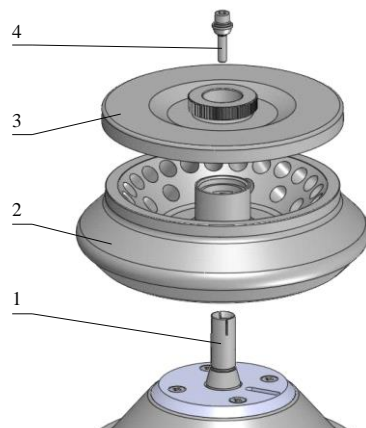


**Fig.1. General view**



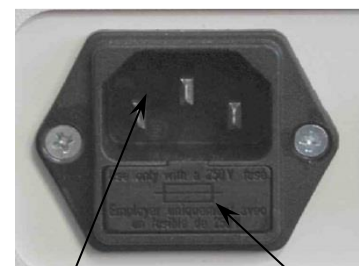
**Fig.2. Right side of centrifuge**

- 1. Motor axle
- 2. Rotor
- 3. Rotor lid
- 4. Complete clamp



**Fig.3. Assembly of angle rotor**

**Fig.4. Mains socket back of the centrifuge**

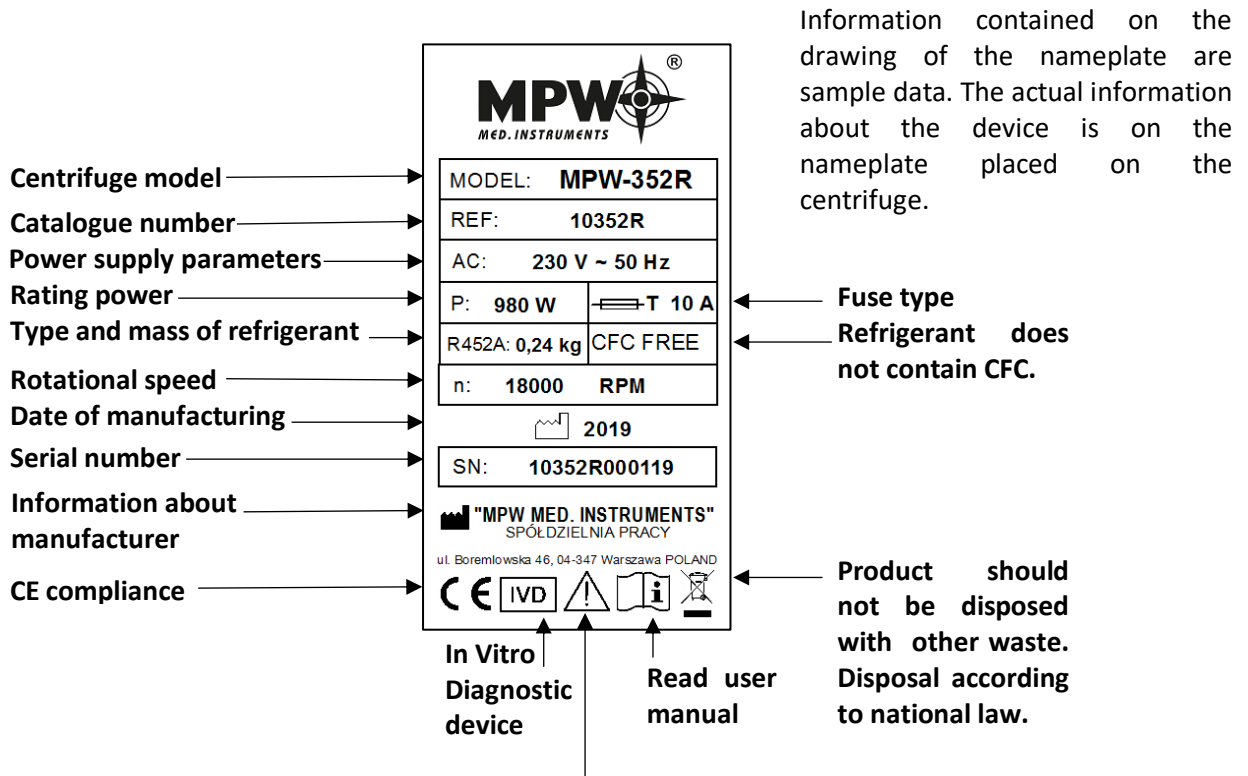


- 1. Plug-in socket
- 2. Fuse socket

### 5.3 Construction

The centrifuge has rigid self-supporting structure. Housing was made of sheet aluminum, back made of steel sheet. Front and cover was made of ABS type plastic. Cover is fixed on steel axles of hinges and from the front it is locked with electromagnetic lock blocking possibility of opening during centrifugation. Rotation chamber casing was made of thick steel sheet. The rotation chamber is made of stainless steel sheet.

### 5.4 Name plate



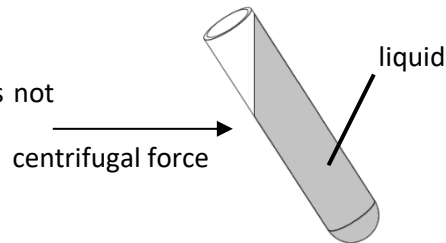
### 5.5 Rotor and accessories installation

- Connect the centrifuge to the mains (master switch on the back side of the centrifuge).
- Turn on the centrifuge (button on the side of the centrifuge).
- Open the cover of the centrifuge by pressing the **COVER** key (see section Centrifuging/Control Panel). Prior to putting the rotor in, one has to check if the rotating chamber is free of impurities, e.g. such as dust, glass splinters, residues of fluids that must be taken away.
- One shall fit the rotor on the motor shaft driving it home on the cone.
- Screw-in the clamp for fixing the rotor (clockwise) and screw it tightly home with the supplied spanner for the rotor.
- Swing-out rotors have to be provided with the buckets in all seats. One should remember that every buckets swings individually. Bucket suspension studs should be lubricated periodically with petroleum jelly.



- In case of rotors designed with the cover they must not be used without it. Rotor covers must be closed exactly. Rotor covers ensure smaller drags of the rotors, proper setting of the test-tubes and airtight sealing.
- One should use only buckets intended for selected types of the rotor.
- Fill test tubes outside the centrifuge.
- In case of centrifuging in an angle rotor, test tubes (buckets) have to be filled properly in order to prevent from pouring fluids during centrifuging.

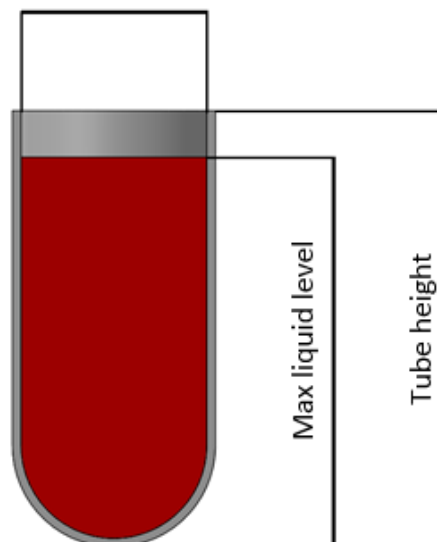
Tubes must be filled so that the material does not escape.



- One shall fill tubes according to formula:

$$\text{Max liquid level} < \text{Tube height} - \frac{\text{Internal tube diameter}}{2}$$

Internal tube diameter



Additionally observe the manufacturer's restrictions about the filling of the test tube.



**It is recommended to equalize vessels loads as much as possible in order to ensure minimal vibrations during operation.**

- In order to prolong lifetime of the rotor and gaskets rotors shall be lubricated with the maintenance oil, while gaskets and threaded parts shall be lubricated with the petroleum jelly.
- For replacement of the rotor one shall unscrew clamp and then grab the rotor with both hands at opposite sides, taking it away from drive shaft by pulling it up.

## 5.6 Control device

The microprocessor control unit of the centrifuge ensures broad possibilities of providing, realization and reading of work parameters.

## **5.7 Setting parameters**

Data setting and read-out system forms hermetically closed keyboard with distinctly accessible operation points. Easily readable displays signalling individual performed operations facilitate operator's programming and recording of parameters and condition of the centrifuge.

The centrifuge is provided with the USB interface that enables connection of the centrifuge to external PC unit with the printer and recording the centrifugation parameters.

## **5.8 Safety features**

### ***Cover lock***

The centrifuge can be started only with properly closed cover. While, the cover can be opened only after stopping the rotor. In case of emergency opening of the cover during operation, the centrifuge drive will be immediately switched-off and the rotor will brake till complete stopping.

### ***Unbalance detecting***

When loads of opposite buckets or carriers in rotors are unbalanced, the drive will be switched-off during acceleration or operation of the centrifuge – and the error message will be displayed.

### ***Rotor verification and checking compatibility with loaded program***

Directly after starting centrifuging, a unit verifies the type of the rotor applied and in the case of its incompatibility with the type indicated in the application or absence of the rotor, the spinning process shall be stopped with simultaneous displaying the error message. The conformity of the type of the rotor is signalled with a single audible signal. In case autoidentification (see 9.8 Other) option is checked, proper rotor will be automatically chosen, without user engagement.

### ***Rest state inspection***

Opening of the centrifuge's cover by **COVER** button is possible only when the rotor in the state of rest. Use inspection glass in cover for be sure if rotor is in the rest state. When the rotor is being stopped, braking symbol (see 6.2) is visible and goes off when it is stopped. Emergency cover opening during rotor running is prohibited.

### ***Checking of excessive temperature***

If temperature in rotation chamber exceeds 50°C (MPW-352) / 65°C (MPW-352R/RH) caused by, for example, malfunction of cooling system, drive will be switched off and error message will be displayed. The reboot is only possible after chilling device.

## **5.9 Increase in temperature (MPW-352 only)**

In uncooled centrifuges, the temperature in the rotor chamber, rotor and sample can increase to above 40°C, based on the run time, g-force (rcf)/speed and ambient temperature.

## 6 Centrifuging

Power switching ON/OFF is carried out with master switch situated on the right side wall of the centrifuge. All settings on the centrifuge are done by means of the control panel.

### 6.1 Control panel

The control panel placed on the front casing serves the purpose of controlling centrifuge operation.



**Control panel**

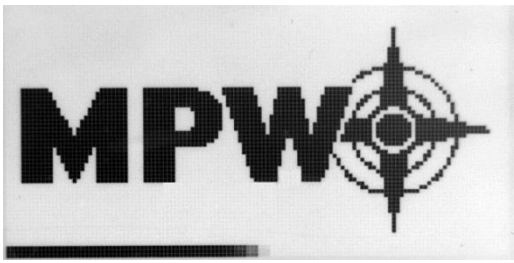


	SHORT <sup>1</sup>	short-time centrifuging
	START	start centrifugation run
	STOP <sup>2</sup>	end centrifugation run
	COVER	cover opening
	FAST COOL	start fast cooling mode (MPW-352R and MPW-352RH only)
	BACK/ OPTIONS	exit the current menu / enter to submenu of options (keep held down within 1 s.)
	UP	navigation in menu / increasing values
	DOWN	navigation in menu / decreasing values
	LEFT	navigation in menu
	RIGHT	navigation in menu
<b>SET</b>	SET	changing parameters / confirming changes

<sup>1</sup> the centrifuge is working as long as the key is pressed









<sup>2</sup> first-time pressing press – will make stopping centrifuging with acceleration characteristics set in the current program, second-time pressing – will make the centrifuging as fast as possible (quickest characteristic). During setting of the parameters, it serves for exiting zones on the primary screen without introducing changes.

















## 6.2 Display

The display is located in the centre of the control panel. The main screen variants are presented below. In the user manual exemplary screens from MPW-352R/352RH are shown. For MPW-352 (without refrigeration) temperature is not shown. Blinking of field on display mean it is ready to set. Blinking of field is visualised as highlighted in the user manual.

	<p>After switching on centrifuge, welcome screen appear. After disappearing the welcome screen it is possible to setting up parameters.</p>
	<p><b>Simplified</b> display mode is set as default, there is possible to switch to <b>normal</b> (see chapter 9.3).</p>
	<p><b>Normal</b> display contains an expanded number of settings visible during operation.</p>
<p>Detailed information on display modes is provided in chapter 9.3.</p>	

<b>SPEED</b>	rotor speed	assigned/measured
<b>RCF</b>	relative centrifugal force	assigned/measured
<b>TIME</b>	centrifuging time	assigned/measured
<b>TEMP</b>	temperature	assigned/measured
<b>PRG</b>	program no.	
<b>11199</b>	rotor no.	
<b>PARAM</b>	parameters of the centrifuge	
<b>MENU</b>	configuration menu	

	changing values		
	user multi sections curve		
	density > 1,2 g/cm <sup>3</sup>		
	centrifuging radius changed		
	counting time down (decreasing)		counting time up (increasing)
	cooling to assigned temperature		
	FAST COOL mode cooling		




	centrifuging		centrifuging (with automatic cover opening)
	rotor stopped / closed cover		rotor stopped / opened lid
	braking		fastest decelerating
	rotor identification		
	thermal chamber		
	temperature delay		
	time delay		
	drop-down list		
	temporarily disabled		
	locked		
	time counting (blinking)		
	disabled option		active option

### 6.3 Setting up RPM, RCF, time, temperature




On the main screen, it is possible to set:

rotating speed - RPM	<b>SPEED</b>
relative centrifugal force (multiple of g-force)	<b>RCF</b>
centrifuging time	<b>TIME</b>
centrifuging temperature	<b>TEMP</b>




Exemplary change of **SPEED** setting:


	<ul style="list-style-type: none"> <li>▪ Press <b>SET</b> (to enter edit mode) –  appears.</li> <li>▪ Via <b>▲▼◀▶</b> keys mark <b>SPEED</b> field (blinking).</li> <li>▪ Press <b>SET</b> –  blinking.</li> <li>▪ Via <b>◀▶</b> choose order of magnitude of changing value (blinking).</li> <li>▪ With <b>▲▼</b> choose demanded value.</li> <li>▪ Repeat above two steps for other orders of magnitude.</li> <li>▪ Confirm settings by pressing <b>SET</b>.</li> <li>▪ Press <b>BACK</b>.</li> </ul>
<ul style="list-style-type: none"> <li>▪ When RPM is changed, RCF is automatically corrected.</li> </ul>	



Exemplary change of **RCF** setting:

 <p>The screenshot shows the control panel with the following fields: SPEED 2000, RCF 300, TIME 00:02:00, TEMP 20°C +20, and PROG: -- 11199/----- PARAM+ MENU+. The RCF field is highlighted with a grey background.</p>	<ul style="list-style-type: none"> <li>▪ Press <b>SET</b> (to enter edit mode) -  appears.</li> <li>▪ Via <b>▲▼◀▶</b> keys mark <b>RCF</b> field (blinking).</li> <li>▪ Press <b>SET-</b> blinking.</li> <li>▪ Via <b>◀▶</b> choose order of magnitude of changing value (blinking).</li> <li>▪ With <b>▲▼</b> choose demanded value.</li> <li>▪ Repeat above two steps for other orders of magnitude.</li> <li>▪ Confirm settings by pressing <b>SET</b>.</li> <li>▪ Press <b>BACK</b>.</li> </ul>
<ul style="list-style-type: none"> <li>▪ When RCF is changed, RPM is automatically corrected.</li> </ul>	


Exemplary change of **TIME** setting::



 <p>The screenshot shows the control panel with the following fields: SPEED 2000, RCF 300, TIME 00:02:00, TEMP 20°C +20, and PROG: -- 11199/----- PARAM+ MENU+. The TIME field is highlighted with a grey background.</p>	<ul style="list-style-type: none"> <li>▪ Press <b>SET</b> (to enter edit mode) -  appears.</li> <li>▪ Via <b>▲▼◀▶</b> keys mark <b>TIME</b> field (blinking).</li> </ul>
<p style="text-align: center;"><b>0 0 : 0 2 : 0 0</b></p> <p style="text-align: center;">[hh : mm : ss]</p> <p>e.g.:</p> <p>centrifuging time – 2 minutes 00 seconds</p>	<ul style="list-style-type: none"> <li>▪ Press <b>SET-</b> blinking.</li> <li>▪ Via <b>◀▶</b> choose order of magnitude of changing value (blinking).</li> <li>▪ With <b>▲▼</b> choose demanded value.</li> <li>▪ Repeat above two steps for other orders of magnitude.</li> <li>▪ Confirm settings by pressing <b>SET</b>.</li> <li>▪ Exit edit mode by pressing <b>BACK</b>.</li> </ul>
<p style="text-align: center;"><b>00:02:00</b></p>	<p>set value</p>
<p style="text-align: center;"><b>02:00</b></p>	<p>current value (most significant digits)</p>

<b>HOLD mode</b>	continuous run mode
	<ul style="list-style-type: none"> <li>To run centrifuging in <b>HOLD</b> mode set <b>00:00:00</b> time.</li> <li>To end centrifuging in HOLD mode press <b>STOP</b>.</li> </ul>

Exemplary change of <b>TEMP</b> setting:	
	<ul style="list-style-type: none"> <li>Press <b>SET</b> (to enter edit mode) –  appears.</li> <li>Via <b>▲▼◀▶</b> keys mark <b>TEMP</b> field (blinking).</li> <li>Press <b>SET</b> key.</li> <li>With <b>▲▼</b> choose demanded value.</li> <li>Confirm settings by pressing <b>SET</b>.</li> <li>Press <b>BACK</b>.</li> </ul>


#### 6.4 Users programs

	<p>After switching centrifuge on, program that was used in previous session is being loaded. If any program was not used in previous session, centrifuge resume the last chosen parameters.</p>
---	---

Program choosing:	
Entering the program selection mode for the <b>simplified display</b> :	
	<ul style="list-style-type: none"> <li>Press and hold  by 1 second.</li> <li>Choose <b>PROG</b> with <b>▲▼</b></li> <li>Press <b>SET</b>.</li> </ul>

Entering the program selection mode for the **normal display**:



- Press **SET** key –  appears.
- Via **▲▼◀▶** keys mark **PRG-** field (highlighted)
- Press **SET** key – list of programs is visible.

Program selection mode tab:

No	SPEED	RCF	TIME	TEMP	ACC	DEC	ROT
0	4590	2826	HOLD	20	0	0	11740
1	4590	2826	00:01:00	20	0	0	11740
▶ 2	5090	3476	00:02:00	20	0	0	11740
3							
4							

- Via **▲▼** choose demanded program.
- Confirm with **SET** key.

No	SPEED		C	DEC	ROT
0	4590	LOAD SAVE DELETE CURVES ----- NEW PROGRAM	0	0	11740
▶ 1	4590		0	0	11740
2	5090		0	0	11740
3			0	0	11740

**LOAD, SAVE, DELETE, NEW PROGRAM**  
 refer choosen program which is marked by ▶.

No	SPEED		C	DEC	ROT
0	4590	SAVE ? ----- YES NO	0	0	11740
▶ 1	4590		0	0	11740
2	5090		0	0	11740
3			0	0	11740

**SAVE** – save settings as a program (confirm by selecting **YES** and pressing **SET**)

No	SPEED		C	DEC	ROT
0	4590	DELETE ? ----- YES NO	0	0	11740
▶ 1	4590		0	0	11740
2	5090		0	0	11740
3			0	0	11740

**DELETE** – delete program (confirm by selecting **YES** and pressing **SET**)

No	SPEED		C	DEC	ROT
0	4590	LOAD SAVE DELETE CURVES ----- NEW PROGRAM	0	0	11740
▶ 1	4590		0	0	11740
2	5090		0	0	11740
3			0	0	11740

**NEW PROGRAM**– enter to create new program mode (as below)



Creating a new program:

		<ul style="list-style-type: none"> <li>Press <b>SET</b> key.</li> <li>Via ▲▼◀▶ keys mark <b>PROG</b> field (blinking).</li> <li>Press <b>SET</b> key. List of programs is visible, choose demanded position (number of program).</li> <li>Press <b>SET</b> key- menu of program settings will appear.</li> <li>Choose <b>NEW PROGRAM</b> press <b>SET</b> and <b>BACK</b>, and then set demanded parameters of centrifuging (look chapter 6. Centrifuging).</li> <li>In case you want to register new program, back to the <b>PROG</b> menu and save it as described before.</li> </ul>

▪ **Changing parameters during centrifuging**

There is a possibility to change parameters: **SPEED, RCF, TIME, TEMP** during centrifuging. Such modifications inactivate currently running program. When program was set, modification during run is represented by **PROG --** symbol (instead of the program number).

<p>User multi-section <b>acceleration/deceleration</b> characteristics</p>	<p><b>CURVES</b> – create acceleration or deceleration characteristics</p>
	<ul style="list-style-type: none"> <li>With ▲▼ keys choose saved program for which you intend to create the acceleration or deceleration characteristics (marked with symbol ▣).</li> <li>Press <b>SET</b>.</li> <li>With ▲▼ keys choose <b>CURVES</b>.</li> <li>Press <b>SET</b> - the selection frame is displayed.</li> </ul>

	<ul style="list-style-type: none"> <li>With ▲▼ keys choose <b>ACCELERATION</b> to create acceleration characteristics or <b>DECELERATION</b> to create deceleration characteristics</li> <li>Confirm selection by pressing <b>SET</b>.</li> </ul>
--	---

<b>Acceleration</b> characteristic	PROG / CURVES / <b>ACCELERATION</b>	
<p>After choosing <b>PROG → CURVES → ACCELERATION</b> the window of the characteristics wizard will be displayed:</p> <p><b>Current acceleration characteristic connected with the loaded program will be displayed on the screen.</b></p>		
	<b>NO.</b>	section no. (max. 4)
	<b>TIME</b>	total acceleration time
	<b>SPEED</b>	final RPM
	<b>ACC:12</b>	characteristic's no. (10-19)

In the first moment, the **EXIT** field is marked (the message is blinking). Pressing the **SET** key will cause returning to the **PROG → CURVES** fold, without making changes in the acceleration characteristics. Press ▲ to start programming "1" section.


### „1" SECTION

- Press **SET**.
- With ▲▼ choose time for section, press **SET**.
- With ▲▼ choose speed for section, press **SET**.

**The set speed value is limited by the maximum speed of the rotor connected with the edited program. After the end of programming the speed, the graphical displaying of the section (of all sections) will occur TIME+SPEED of the user's acceleration characteristics.**

After programming the section 1, there is a possibility to program the next section, number 2. It is possible also to abandon the programming: with UP/DOWN keys choose the **EXIT** option (it will blink) and save (press the **SET**) only the acceleration characteristics of 1 section with **TIME/SPEED** parameters described in the line 1.


## „2” SECTION

NO	TIME	SPEED	5090
1	0:00:33	5090	
2	0:00:00	5090	
ACC:12   EXIT			0:00:33

Programming of new section possible (the whole line 2 is blinking). Programming as in the case of section 1. It is possible also to abandon the programming: with UP/DOWN keys choose the **EXIT** option (it will blink) and save (press the **SET**) only the acceleration characteristics of 1 section with **TIME/SPEED** parameters described in the line 1.


The minimal speed of the next section of acceleration characteristics is equal to the speed of the already programmed previous section.

## „3” SECTION

NO	TIME	SPEED	5090
1	0:00:33	5090	
2	0:00:46	5090	
3	0:00:00	5090	
ACC:12   EXIT			0:01:19

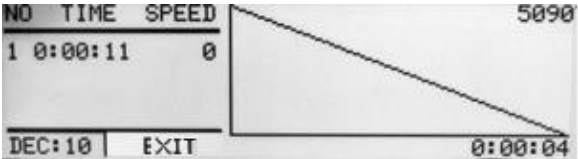
Programming of new section possible (the whole line 3 is blinking). Programming as in the case of section 1. It is possible also to abandon the programming: with ▲▼ keys choose the **EXIT** option (it will blink) and save (press the **SET**) only the acceleration characteristics of 2 section with **TIME/SPEED** parameters described in the line 1 and 2.

## „4” SECTION

NO	TIME	SPEED	5300
1	0:00:33	5090	
2	0:00:46	5090	
3	0:01:00	5300	
4	0:00:00	5300	
ACC:12   EXIT			0:02:19

Programming of new section possible (the whole line 4 is blinking). Programming as in the case of section 1. It is possible also to abandon the programming: with ▲▼ keys choose the **EXIT** option (it will blink) and save (press the **SET**) only the acceleration characteristics of 3 section with **TIME/SPEED** parameters described in the line 1, 2 and 3.

Repeated attempt to program already programmed sections of the acceleration characteristics will cause beginning of programming of the whole acceleration characteristics once again (with settings of the program loaded to edition).

Deceleration characteristic:	PROG / CURVES / DECELERATION		
<p>After choosing <b>PROG</b> → <b>CURVES</b> → <b>DECELERATION</b> the window of the characteristics wizard will be displayed:</p> <p><b>Default deceleration characteristics connected with the loaded program will be displayed on the screen. Creating of deceleration characteristics takes place a little differently than acceleration characteristics.</b></p>			
	<b>NO.</b>	section no. (max. 4)	
	<b>TIME</b>	total acceleration time	
	<b>SPEED</b>	final RPM	
	<b>DEC:10</b>	characteristic's no. (10-19)	

In the first moment, the **EXIT** field is marked (the message is blinking). Pressing the **SET** key will cause returning to the **PROG** → **CURVES**, without making changes in the deceleration characteristics. Press **▲** to start programming "1" section.

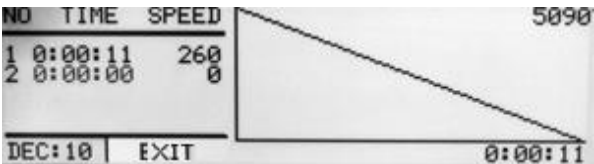
### „1" SECTION

- Press **SET**.
- With **▲ ▼** choose time for section, press **SET**.
- With **▲ ▼** choose speed for section, press **SET**.

**In order to complete the creation of the deceleration curve it is necessary for the speed of the last of programmed sections of the curve to be equal = 0. Otherwise the curves wizard will not enable the end of programming (it will be impossible to select the EXIT option).**

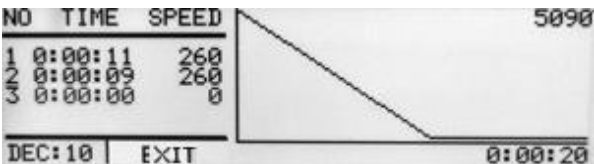
After programming the section 1, there is a possibility to program the next section, number 2. You can opt out of the following sections by pressing **EXIT**.

### „2" SECTION

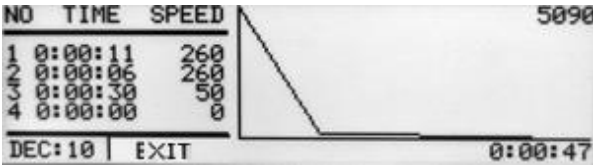
	<p>New section programming possible (the whole line 2 is blinking). Programming as in the case of the section 1. To stop creating the deceleration curve at the stage of two sections, it is necessary to set the speed in section 2 to 0 and press the <b>SET</b> key and then choose <b>EXIT</b> and press <b>SET</b>.</p>
---	--

**The maximum speed of the next section of deceleration characteristic is equal to the speed programmed already of the previous section.**

### „3" SECTION

	<p>New section programming possible (the whole line 3 is blinking). Programming as in the case of the section 1. To stop creating the deceleration curve at the stage of three sections, it is necessary to set the speed in section 3 to 0 and press the <b>SET</b> key and then choose <b>EXIT</b> and press <b>SET</b>.</p>
---	--



## „4” SECTION

	<p>New section programming possible (the whole line 4 is blinking). Programming as in the case of the section 1. If speed of the last section=0, it is possible to save the created characteristics by choosing the <b>EXIT</b> option with ▲▼ keys and pressing the <b>SET</b> key and then choose <b>EXIT</b> and press <b>SET</b>.</p>
---	---

Repeated attempt to program already programmed sections of the acceleration characteristics will cause beginning of programming of the whole deceleration characteristics once again (with settings of the program loaded to edition).





### 6.5 Programs with user characteristics

Loading a modified program in the **CURVES** fold is signalled by the icon on the main screen:

	<p>Icon  signals that program with user acceleration/deceleration characteristics are loaded.</p>
--	---

A change in any parameter entails the deactivation of the multi-sections curves mode.

### 6.6 Rotor choosing


<p><b>Simplified display mode</b></p>	
	<ul style="list-style-type: none"> <li>▪ Press and hold  by 1 second.</li> <li>▪ Choose rotor number (exemplary <b>11199/-----</b>) with ▲ ▼.</li> <li>▪ Press <b>SET</b>.</li> <li>▪ Execute points described follow (below <b>Normal display mode</b> description)</li> </ul>
<p><b>Normal display mode</b></p>	
	<ul style="list-style-type: none"> <li>▪ Press <b>SET</b>— appears.</li> <li>▪ Via ▲▼◀▶ mark rotor choosing field.</li> </ul>

NO	ROTOR	BUCKET	SPEED	RCF	RMAX	RMIN
1	11199	-----	18000	24270	67	35
2	11210	-----	5000	3997	143	60
3	11211	-----	5500	4498	133	87
4	11213	-----	5500	4227	125	79
5	11259	-----	15000	24400	97	65
6	11273	-----	12000	14006	87	54







- Press **SET** (Rotor list will appear).
- Via ▲ ▼ keys mark demanded rotor number
- Confirm by press **SET**.
- Press **BACK**.

It is possible to set **AUTOMATIC ROTOR IDENTIFICATION**.  
The procedure is described in subsection **9.8**.

## 6.7 SHORT mode

	<ul style="list-style-type: none"> <li>The <b>SHORT</b> mode is activated by pressing and holding ►►(SHORT).</li> <li>In <b>SHORT</b> mode the centrifuge is working as long as the <b>SHORT</b> key is pressed or when set time is over.</li> </ul>
---	--

## 6.8 Finishing the centrifuging

	When preselected time is reached, centrifugation will end automatically.
	
 x1	<ul style="list-style-type: none"> <li>Before lapse preselected time one may stop centrifugation. Pressing <b>STOP</b> for the first time will stop centrifuging with the characteristic set in loaded program.  symbol will be shown.</li> </ul>
 x2	<ul style="list-style-type: none"> <li>Pressing <b>STOP</b> second time will stop centrifuging with the fastest characteristic.  symbol will be shown.</li> </ul>
	
	<ul style="list-style-type: none"> <li>The message about cancel of centrifuging can be delete with the <b>STOP, SET, COVER, ▲ ▼ ◀ ▶</b> or <b>BACK</b> key.</li> </ul>

## 6.9 Temporarily disabled functions

Functions written below can be temporarily disabled.

active	SPEED	RCF	TIME	TEMP	PROG —	—— / ——	PARAM	MENU
THERMAL CHAMBER	●	●	●	○	●	●	●	●
STANDARD CENTRIFUGING	●	●	●	●	●	○	●	○

- available
- disabled


## 7 Temperature control




MPW-352R and MPW-352RH only

Centrifuge is equipped with ecological refrigerating system with temperature control. During centrifugation, there may appear differences in temperature on the display and temperature of the samples in the rotor. It depends on thermal conductivity of the rotor, and samples and centrifugation time, initial temperature of rotor and samples.

Exemplary change of **TEMP** setting:




	<ul style="list-style-type: none"> <li>▪ Press <b>SET</b> (to enter edit mode)  – appears.</li> <li>▪ Via <b>▲▼◀▶</b> keys mark <b>TEMP</b> field (blinking).</li> <li>▪ Press <b>SET</b> key.</li> <li>▪ With <b>▲▼</b> choose demanded value (from -20°C to 40°C for 352R, from -20°C to 55°C for 352RH).</li> <li>▪ Confirm settings by pressing <b>SET</b>.</li> <li>▪ Press <b>BACK</b>.</li> </ul>
--	---

	<ul style="list-style-type: none"> <li>▪ Cooling is indicated by a symbol  (blinking).</li> </ul>
--	--

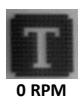
### 7.1 Initial cooling during centrifuging –**FAST COOL**

	<ul style="list-style-type: none"> <li>▪ The parameters allowable to change at <b>FAST COOL</b> mode:             <ul style="list-style-type: none"> <li>▪ temperature (lower than current temperature shown by centrifuge)</li> </ul> </li> <li>▪ In order to centrifuging reduced temperature samples (eg. storage in the external refrigerator) centrifuge chamber, rotor and centrifuge container must be pre-cooling to the predetermined temperature. It cause minimalization of temperature differences.</li> <li>▪ Initial cooling may be activated by <b>FAST COOL</b> key (lid must be closed – rotor is spinning at <b>FAST COOL</b> mode)</li> <li>▪ When <b>FAST COOL</b> mode is active, cooling system automatically set proper parameters to obtain demanded temperature the fastest way.</li> </ul>
--	--




	<p><b>FAST COOL</b> mode is marked by symbol  blinking in the right upper side of display.</p>
	<p>It is possible to exit <b>FAST COOL</b> mode at any time by pressing <b>STOP</b> key.</p> <p>Interruption of the function is signaled by a message.</p>


## 7.2 Initial cooling or heating without centrifuging – THERMAL CHAMBER

	PARAM → <b>THERMAL CHAMBER</b>
	<ul style="list-style-type: none"> <li>There is possible to run centrifuge in THERMAL CHAMBER mode - cooling for R, cooling and heating for RH (rotor is at standstill).</li> <li>How to enable <b>THERMAL CHAMBER</b> is described in Parameters of centrifugation chapter.</li> </ul>

## 7.3 Cooling or heating in “START DELAY – OF TEMPERATURE” mode

	PARAM → <b>START DELAY – OF TEMPERATURE</b>
	<ul style="list-style-type: none"> <li>Centrifuging process will start, when preselected temperature is reached.</li> <li>How to enable run <b>START DELAY – OF TEMPERATURE</b> function is described in Parameters of centrifugation chapter.</li> </ul>




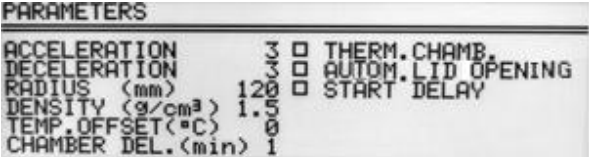
## 7.4 Cooling or heating in „SHORT” mode

	<ul style="list-style-type: none"> <li>Cooling and heating features are available in SHORT mode.</li> <li>How to enable run centrifugation in <b>SHORT mode</b> is described in Centrifugation/SHORT mode.</li> </ul>
---	---

## 7.5 Cooling and heating notes

Centrifuges with cooling (MPW-352R and MPW-352RH) are equipped with an efficient cooling system. It allows obtaining selected temperatures in the chamber even at maximum spin speed or fast obtaining desired temperatures (e.g. 4°C and 36°C). Note that time and possibility of obtaining a set temperature is dependent on multiple factors, including: the power of the cooling system, the shape of the rotor, the rotor speed, ambient temperature, etc. The accuracy of the temperature stability of  $\pm 1^\circ\text{C}$  (for 352R),  $\pm 3^\circ\text{C}$  (for 352RH) is determined by the installation place of the temperature sensor.

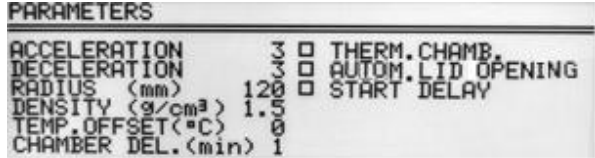
## 8 Parameters of centrifugation

Simplified display	
	<ul style="list-style-type: none"> <li>Press and hold  by 1 second.</li> <li>Choose <b>PARAM.</b> with ▲ ▼</li> <li>Press <b>SET.</b></li> <li>Execute points described follow (below <b>Normal display mode</b> description)</li> </ul>
Normal display	
	<ul style="list-style-type: none"> <li>Press <b>SET.</b></li> <li>With ▲ ▼ ◀ ▶ keys select <b>PARAM.</b></li> <li>Press <b>SET.</b></li> </ul>
	

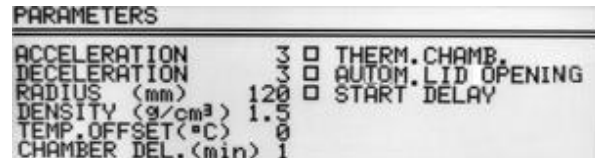


<b>ACCELERATION</b>	chosen acc. characteristic (0-the fastest, 9-the slowest)
<b>DECELERATION</b>	chosen dec. characteristic (0-the fastest, 9-the slowest)
<b>RADIUS [mm]</b>	current rotor radius [mm]
<b>DENSITY (g/cm<sup>3</sup>)</b>	sample density [g/cm <sup>3</sup> ]
<b>TEMP. OFFSET (°C)</b>	value of temperature correction
<b>CHAMBER DEL. (min)</b>	delay between set thermal chamber mode and start it

<b>THERMAL CHAMBER</b>	cooling of the chamber without centrifuging
<b>AUTOM. LID OPENING</b>	opening cover after centrifuging automatically
<b>START DELAY</b>	starting delayed (after pressing START)

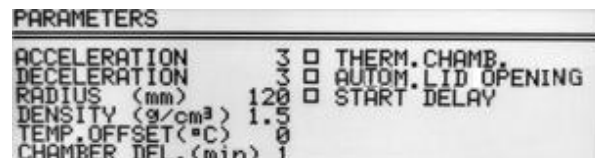
## 8.1 Acceleration/deceleration – changing characteristics



 <pre> PARAMETERS ----- ACCELERATION      3  □ THERM.CHAMB. DECELERATION      3  □ AUTOM.LID OPENING RADIUS (mm)      120 □ START DELAY DENSITY (g/cm³)  1.5 TEMP.OFFSET(°C)   0 CHAMBER DEL.(min) 1           </pre>	<ul style="list-style-type: none"> <li>With ▲▼ keys select <b>ACCELERATION</b> or <b>DECELERATION</b>.</li> <li>Press <b>SET</b>.</li> <li>With ▲▼ keys select demanded number of characteristic.</li> <li>Press <b>SET</b>.</li> <li><b>ACCELERATION</b> –10 (0 ÷ 9), linear accelerating characteristics assigned to every rotor. 0-the fastest acceleration, 9-the slowest acceleration.</li> <li><b>DECELERATION</b> – 10 (0 ÷ 9), linear decelerating characteristics assigned to every rotor. 0-the fastest deceleration, 9-the slowest deceleration.</li> </ul>
--	--

## 8.2 Radius

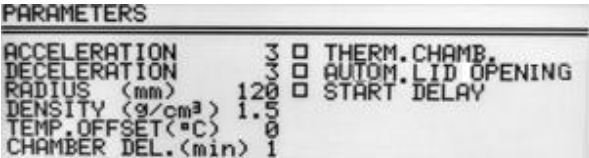
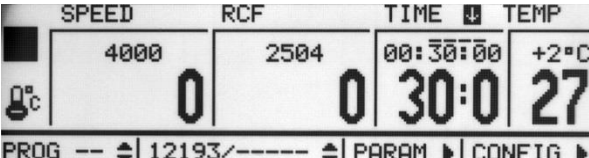


 <pre> PARAMETERS ----- ACCELERATION      3  □ THERM.CHAMB. DECELERATION      3  □ AUTOM.LID OPENING RADIUS (mm)      120 □ START DELAY DENSITY (g/cm³)  1.5 TEMP.OFFSET(°C)   0 CHAMBER DEL.(min) 1           </pre>	<ul style="list-style-type: none"> <li><b>RADIUS [mm]</b> - control of the radius of the rotor within the range from <math>R_{min}</math> to <math>R_{max}</math>. Available values depends on chosen rotor. Radius correction serve for more precise control RCF, exemplary when user need to know real RCF in half length of test tube.</li> <li>To change the rotor radius select <b>RADIUS [mm]</b> with ▲▼ keys.</li> <li>Press <b>SET</b>.</li> <li>Set demanded value by pressing ▲▼.</li> <li>Press <b>SET</b>.</li> </ul>
 <pre> SPEED 2000 0 RCF 496 0 TIME 00:02:00 00:02:00 TEMP 12°C +20 PROG: -- 11740/----- PARAM+ MENU+           </pre>	<p>When radius correction is activated,  symbol is visible on the screen.</p> <p>Reducing of the rotor radius resulting change of displayed RCF value.</p>

## 8.3 Sample density

 <pre> PARAMETERS ----- ACCELERATION      3  □ THERM.CHAMB. DECELERATION      3  □ AUTOM.LID OPENING RADIUS (mm)      120 □ START DELAY DENSITY (g/cm³)  1.5 TEMP.OFFSET(°C)   0 CHAMBER DEL.(min) 1           </pre>	<ul style="list-style-type: none"> <li><b>DENSITY (g/cm<sup>3</sup>)</b> – default density is set to 1,2 g/cm<sup>3</sup></li> </ul> <p>To change the density (possible values 1,2÷9,9 g/cm<sup>3</sup>):</p>
--	---

	<ul style="list-style-type: none"> <li>▪ Via ▲ ▼ keys select <b>DENSITY (g/cm<sup>3</sup>)</b></li> <li>▪ Press <b>SET</b>.</li> <li>▪ Set demanded value by pressing ▲ ▼.</li> <li>▪ Press <b>SET</b>.</li> </ul>
	<p>When density is changed,  symbol is visible on the screen.</p> <p>Changing of <b>DENSITY</b> value is obligatory when density of sample placed into rotor is higher than 1.2 g/cm<sup>3</sup>. Change of <b>DENSITY</b> value lead to decreasing maximum value of accessible speed.</p>

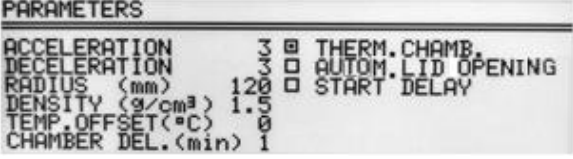

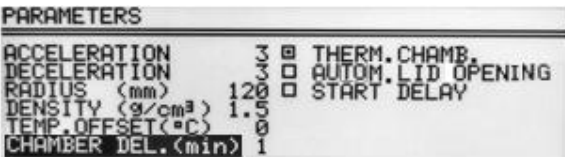
#### 8.4 Temperature offset

	<p>Temperature offset serve for more precise control of real sample temperature. It can be helpful in case high/low initial temperature samples or high volume samples.</p> <ul style="list-style-type: none"> <li>▪ With ▲ ▼ keys select <b>TEMP. OFFSET</b>.</li> <li>▪ Press <b>SET</b>.</li> <li>▪ Use the ▲ ▼ keys to select the difference between the temperature that the cooling system will aim for, and set temperature. Confirm selection by pressing <b>SET</b>.</li> </ul> <p><b>Attention!</b> The use of the offset can not extend the temperature range achieved by the centrifuge.</p> <p><b>Function description</b></p> <p>At a set temperature of 20°C and the set offset value equal to -5°C, cooling system will actually strive to reach 15°C. With a setpoint temperature of 20°C and a set offset value of 5°C the system will actually try to reach 25°C.</p> <p>The temperature displayed on the main screen is corrected for offset value.</p> <p>Offset can be selected range from -20°C to 20°C.</p>
	<p>Activation of the function is signaled on the main screen with  or  depending on the offset value sign.</p>

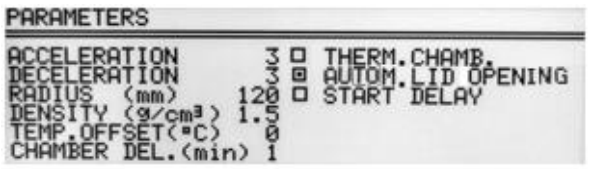
## 8.5 Thermal chamber





MPW-352R and MPW-352RH only


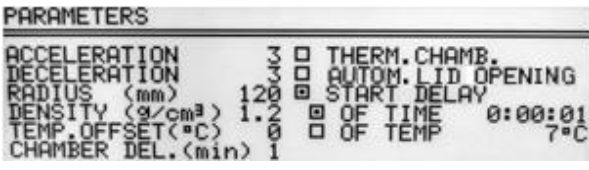


Cooling without centrifuging.	<b>THERMAL CHAMBER</b>
	<ul style="list-style-type: none"> <li>▪ With ▲▼◀▶ keys select <b>THERMAL CHAMBER</b>.</li> <li>▪ Press <b>SET</b> (to turn on/off).</li> <li>▪ With ▲▼ keys select temperature value. Set demanded value (0°C÷40°C) by pressing ▲▼. Confirm selection by pressing <b>SET</b>. Attention, in the centrifuge without heating, do not set the thermal chamber to a value higher than currently indicated by the centrifuge.</li> </ul>
	<ul style="list-style-type: none"> <li>▪ When THERMAL CHAMBER function is activated, <b>T</b> symbol is visible on the screen.</li> <li>▪ Changing temperature from the main screen is not possible.</li> <li>▪ Opening cover terminates THERMAL CHAMBER function (closing cover back turns it on).</li> </ul>
	<ul style="list-style-type: none"> <li>▪ Thermal chamber is activated with delay. Set time of delaying by select <b>CHAMBER DEL.</b></li> <li>▪ Press <b>SET</b>.</li> <li>▪ With ▲▼ keys select demanded value (1-5 min).</li> <li>▪ Press <b>SET</b>.</li> </ul>
<ul style="list-style-type: none"> <li>▪ If <b>THERMAL CHAMBER</b> is turned on (in <b>PARAM</b>) and centrifugation completes, THERMAL CHAMBER will activate itself.</li> <li>▪ <b>THERMAL CHAMBER</b> can be only activated when any other program is not running.</li> </ul>	

## 8.6 Automatic lid opening

Automatic lid opening	<b>AUTOMATIC LID OPENING</b>
	<ul style="list-style-type: none"> <li>When centrifuge process is finished, cover will be opened automatically for set option AUTOM. LID OPENING.</li> <li>When centrifuging is terminated by pressing <b>STOP</b>, opening cover is possible by pressing <b>COVER</b>.</li> </ul>

	<ul style="list-style-type: none"> <li> symbol means that OPEN LID AFTER RUN is active.</li> </ul>
---	---

## 8.7 Start delay - of time

	Start centrifuging since preselected delay is reached.	<b>START DELAY / OF TIME</b>
	<ul style="list-style-type: none"> <li>With <b>▲▼</b> keys select START DELAY. Press <b>SET</b>.</li> <li>Start delay can be set from 0 : 0 0 : 0 1 to 9 : 5 9 : 5 9.</li> <li>With <b>▲▼</b> keys select OF TIME. Press <b>SET</b> and <b>▶</b> and then <b>SET</b>.</li> <li>With <b>▲▼</b> keys set demanded value.</li> <li>Confirm by pressing <b>SET</b>.</li> <li>Press <b>BACK</b> to escape edit mode.</li> </ul>	
	<ul style="list-style-type: none"> <li>When START DELAY function is activated,  symbol is visible on the screen.</li> </ul>	
<p>START DELAY / <b>OF TIME</b> function cannot be run when START DELAY / <b>OF TEMP.</b> is activated.</p>		

## 8.8 Start delay – of temperature

	<b>MPW-352R and MPW-352RH only</b>	
	Start centrifuging time counting since preselected temperature is reached.	<b>START DELAY / OF TEMP.</b>
		<ul style="list-style-type: none"> <li>▪ With ▲▼◀▶ keys mark <b>START DELAY</b>.</li> <li>▪ Press <b>SET</b>.</li> <li>▪ With ▲▼◀▶ keys mark <b>OF TEMP</b>.</li> <li>▪ Press <b>SET</b>.</li> <li>▪ Press ▶, press <b>SET</b>.</li> <li>▪ With ▲▼ keys set demanded value of temperature.</li> <li>▪ Press <b>SET</b>.</li> <li>▪ Exit edit mode by press <b>BACK</b>.</li> </ul>
		<ul style="list-style-type: none"> <li>▪ When START DELAY – OF TEMPERATURE is turned on,  symbol is visible on the screen.</li> </ul>
<p>When the function is active, the speed can be reduced to the optimum values for the <b>FAST COOL</b> function, when the set speed is lower than the optimum value, the rotor rotates at the set by user speed.</p>		
<p>START DELAY / <b>OF TEMP</b>. function cannot be run when START DELAY / <b>OF TIME</b> is activated.</p>		

## 8.9 Printing report (USB)

When the centrifuging process is finished there is a possibility to obtain report. Report can be transferred to PC or printed.

### PC (USB)

The elements needed to make connecting your computer via USB:

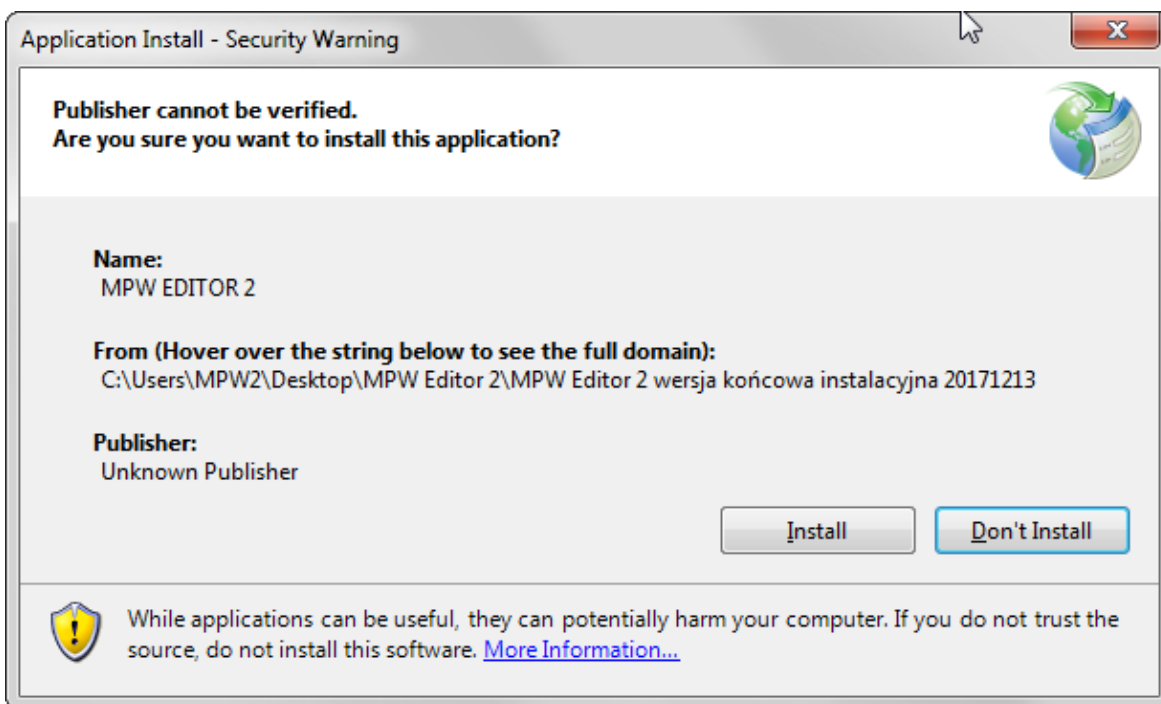
name	quantity (pcs.)	cat. No.
USB A-A cable	1	16655
<b>MPW Editor 2</b> application	1	to downloaded from the website: <a href="http://www.mpw.pl">www.mpw.pl</a>

Operating System Requirements: **Microsoft Windows 10 (64bit).**

The Manufacturer does not guarantee that the program will work correctly with other operating systems.

### Preparation

- Download installation file from website at [www.mpw.pl](http://www.mpw.pl).
- Unzip the file and run **setup.exe**.
- Install **MPW Editor 2** application on the computer, press **Install**.

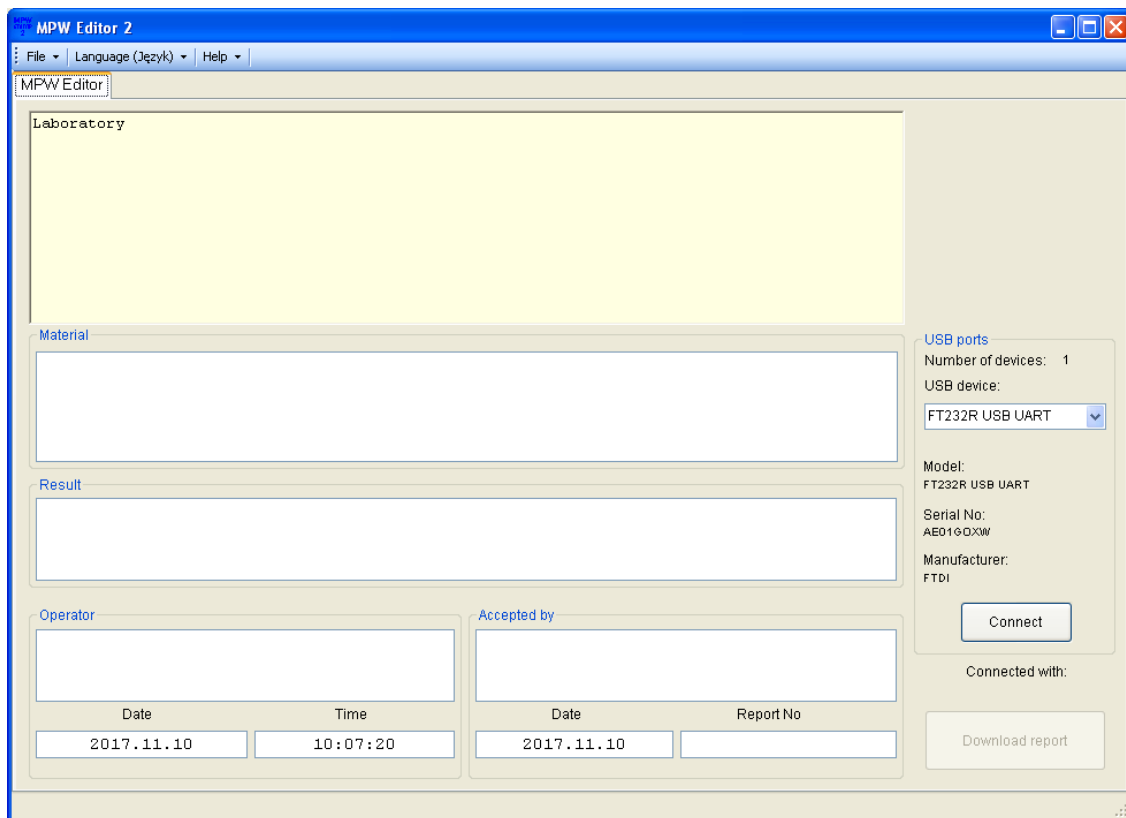


- If necessary install **FTDI USB drivers** and **.NET Framework 4.0** library (download with manufacturer's website: [www.mpw.pl](http://www.mpw.pl)).

### Centrifuging and printing

- Run **MPW Editor 2** application.
- Choose **Język\English**



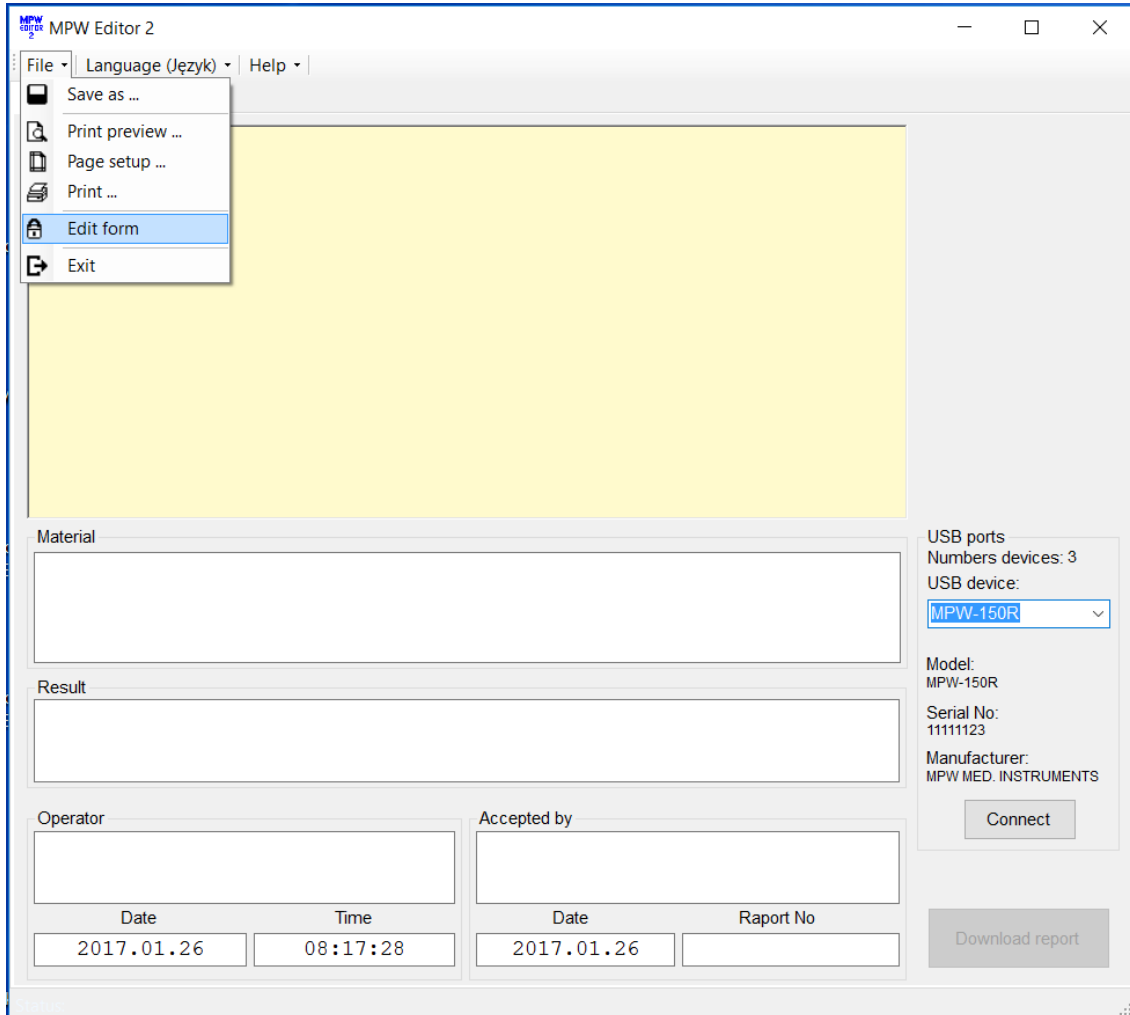


- Connect centrifuge to the PC in accordance with the „**Connection scheme**”
- Choose port assigned to the centrifuge (it will appear after connecting USB cable).

**Attention:**

If the interface has not been programmed: name, serial number and manufacturer's name, the device will be identified by Windows and MPW Editor 2 with the data programmed by FTDI (manufacturer USB integrated circuit) for example FT232R USB UART.

- Choose **File\Edit form**



- In the „Tytuł (Title)” field, you can place any text, for example name of the laboratory, for later use in the report template.

MPW Editor 2

File ▾ | Language (Język) ▾ | Help ▾ |

MPW Editor

Tytuł (Title)

Material  
Próbka (Sample)

Result  
Wynik (Result)

Operator  
Wykonał (Examined by)

Accepted by  
Zaakceptowane (Approved by)

Date Time Date Report No

2017.01.26 08:20:27 2017.01.26 123456

USB ports  
Numbers devices: 3  
USB device:  
MPW-150R ▾

Model:  
MPW-150R  
Serial No:  
1111123  
Manufacturer:  
MPW MED. INSTRUMENTS

Connect

Download report

- Choose **File\Save form**.
- Ensure that USB device is selected from the list of devices.
- Press **Connect**. After successful communication, "PC" appears in the display.

MPW Editor 2

File | Language (Język) | Help

MPW Editor

Tytuł (Title)

Material  
Próbka (Sample)

Result  
Wynik (Result)

Operator  
Wykonał (Examined by)

Accepted by  
Zaakceptowane (Approved by)

Date Time  
Date Raport No  
2017.01.26 123456

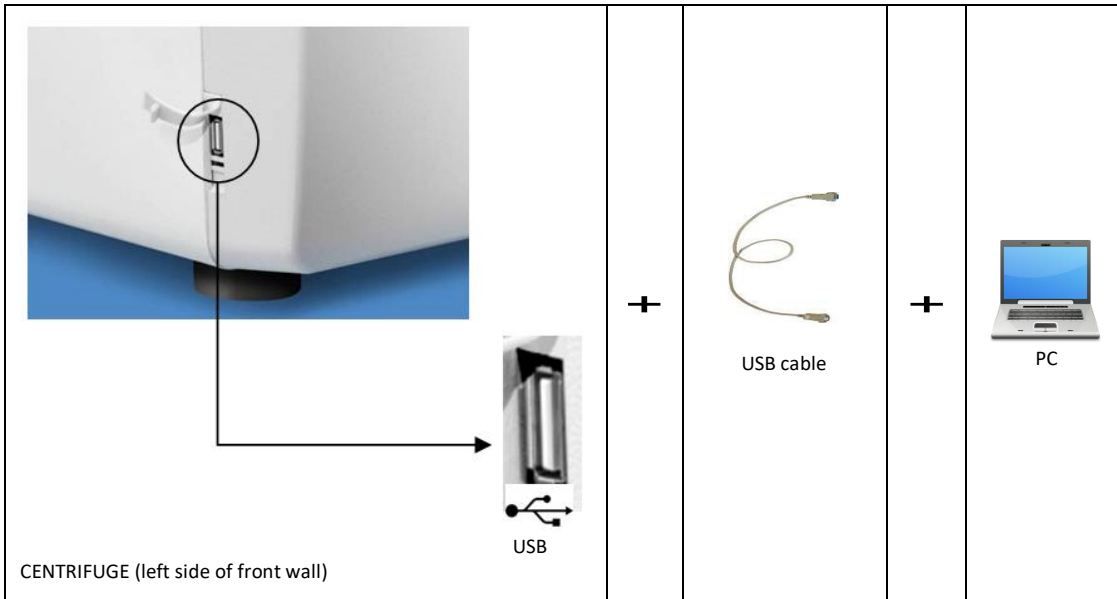
USB ports  
Numbers devices: 3  
USB device: MPW-150R  
Connected with  
Model: MPW-150R  
Serial No: 11111123  
Manufacturer: MPW MED. INSTRUMENTS

Disconnect





Download report

- Fill folds: „Material”, „Result”, „Operator”, „Accepted by”, „Raport no” (optionally).
- When the centrifuging process is finished, press **Download the report**.
- When centrifuging process is completed, report will appear.
- Save report (**File/Save as**) or print it (**File/Print**).
- In order to get another report, press New test and press Download the report.
- After finishing the work, press **Disconnect** button (the "PC" disappears from the display of the centrifuge) and then closes MPW Editor 2.

# Connection diagram




## 9 Menu


Simplified display	
	<ul style="list-style-type: none"> <li>Press and hold  by 1 second.</li> <li>Choose <b>MENU</b> with ▲ ▼</li> <li>Press <b>SET</b>.</li> <li>Execute points described follow (below <b>Normal display mode</b> description)</li> </ul>
Normal display	
	<ul style="list-style-type: none"> <li>Press <b>SET</b>.</li> <li>With ▲ ▼ ◀ ▶ keys select <b>MENU</b>.</li> <li>Press <b>SET</b>.</li> </ul>
	<ul style="list-style-type: none"> <li>To navigate in <b>MENU</b> use ▲ ▼ ◀ ▶ keys. To enter menu press <b>SET</b>.</li> </ul>

<b>CONFIGURATION</b>	centrifuge configuration
<b>PASSWORD</b>	password protection
<b>LAST 10-CYCLES</b>	10 last centrifugation cycles history
<b>CYCLES</b>	total working time of centrifuge, total number of working cycles counter
<b>ROTOR RUNTIME</b>	counting time of work and cycles amount for each rotor
<b>CONTACT US</b>	manufacturer's details
<b>DIAGNOSTICS</b>	error codes (service field)
<b>FACTORY SETTINGS</b>	restore factory settings

### 9.1 Screen saver

Setting time of screen saver	MENU/ CONFIGURATION / <b>SCREEN</b>
	<ul style="list-style-type: none"> <li>With ▲▼◀▶ keys select <b>SCREENSAVER</b>.</li> <li>Press <b>SET</b> and then ▼ and <b>SET</b> .</li> <li>With ▲▼ keys select demanded value from 1 to 60 minutes.</li> <li>Mark selection by pressing <b>SET</b>.</li> <li>Leave the menu by pressing <b>BACK</b>.</li> </ul>

### 9.2 Visual alarm

Visual alarm	MENU/CONFIGURATION/ <b>SCREEN</b>
	<ul style="list-style-type: none"> <li>Via ▲▼ keys choose <b>VISUAL ALARM</b></li> <li>Mark it by pressing <b>SET</b>.</li> </ul> <p><b>VISUAL ALARM</b> cause blinking screen after ending of centrifuging or after message occurring.</p>

### 9.3 Types of main screen



To ensure optimal adaptation to the user's preferences, work is possible in two basic screen modes.

**NORMAL DISPLAY** - contains an expanded number of parameters visible on the display.

**SIMPLIFIED DISPLAY** - contains only the most important parameters visible on the display.



For each of the above modes, you can choose priority RPM display or RCF.

By default, the **SIMPLIFIED DISPLAY** is set


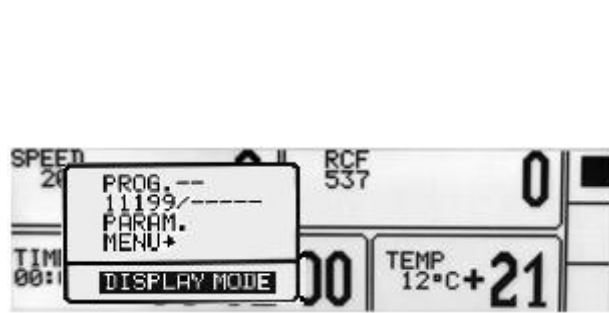
Types of main screen	
NORMAL DISPLAY	SIMPLIFIED DISPLAY
	
Switch between the <b>SPEED</b> (RPM) and <b>RCF</b> display priority modes	

<ul style="list-style-type: none"> <li>▪ In the <b>NORMAL DISPLAY</b> mode, selecting the <b>SPEED</b> or <b>RCF</b> display mode is obtained by pressing and holding <b>BACK</b> for 1 sec.</li> <li>▪ then use the <b>▲ ▼</b> buttons to select the desired mode (<b>SPEED</b> or <b>RCF</b>) and press <b>SET</b>.</li> </ul>	<ul style="list-style-type: none"> <li>▪ In the <b>SIMPLIFIED DISPLAY</b> mode, the selection of the <b>SPEED</b> or <b>RCF</b> display mode is obtained by pressing and holding the <b>BACK</b> key for 1 second.</li> <li>▪ then use <b>▲ ▼</b> keys to select <b>DISPLAY MODE</b>, press <b>SET</b>, and then use <b>▲ ▼</b> keys to select the desired mode (<b>SPEED</b> or <b>RCF</b>) and press <b>SET</b>.</li> </ul>
--	---

**9.3.1 Switching the normal display to simplified display**

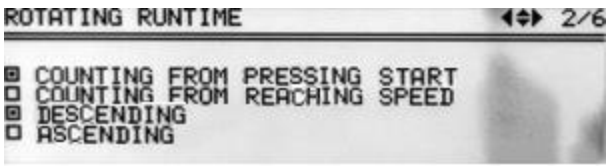
	<ul style="list-style-type: none"> <li>▪ Press the <b>BACK</b> button for 1 sec. then:</li> <li>▪ Via <b>▲ ▼</b> keys select <b>SIMPLIFIED DISPLAY</b>.</li> <li>▪ Press <b>SET</b>.</li> </ul>
	

**9.3.2 Switching the simplified screen to normal display**


	<p>Press the <b>BACK</b> button for <b>1 sec.</b> then:</p>
	<ul style="list-style-type: none"> <li>▪ Via <b>▲ ▼</b> keys select <b>DISPLAY MODE</b> (blinking).</li> <li>▪ Press <b>SET</b>.</li> <li>▪ Then choose <b>NORMAL DISPLAY</b> and press <b>SET</b>.</li> </ul>



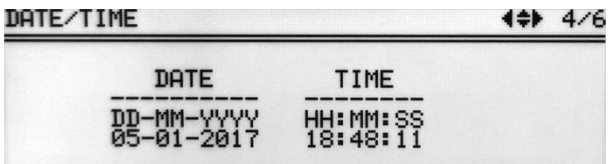
## 9.4 Rotating runtime

Way of time counting	MENU/CONFIGURATION/ <b>ROTATING RUNTIME</b>
	<ul style="list-style-type: none"> <li>Via ▲▼ choose demanded option.</li> <li>Mark it by pressing <b>SET</b>.</li> </ul>
<b>Counting from:</b> Pressing start → Reaching speed →	COUNTING SINCE ROTOR IS IDENTIFIED COUNTING FROM ASSIGNED SPEED
<b>Presenting mode:</b> Descending → Ascending →	COUNTING DOWN COUNTING UP

## 9.5 Buzzer

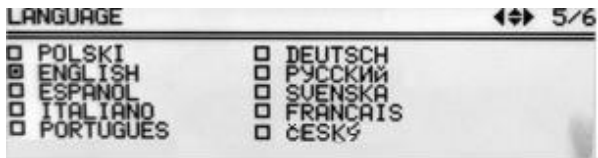
Switching ON/OFF short audible signals accompanying every pressing of any key. Switching ON/OFF signals after centrifuging.	MENU/ CONFIGURATION / <b>BUZZER</b>
	<ul style="list-style-type: none"> <li>With ▲▼ keys select demanded option.</li> <li>Mark selection by pressing <b>SET</b>.</li> </ul> <p>A continuous alarm means the emission of short beeps after the end of the spin, until the message about the end of the work cycle is deleted.</p>
<b>Warning signals are always switched on.</b>	

## 9.6 Date/time

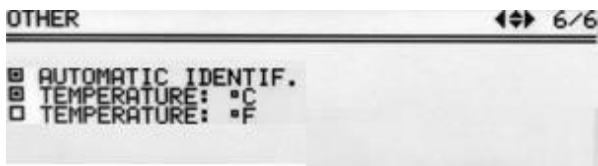
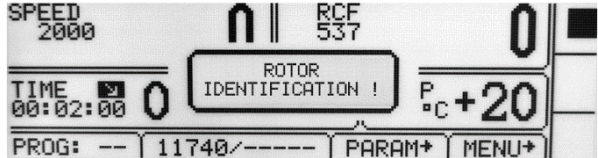
Settiing up time and date	MENU/ CONFIGURATION / <b>DATE/TIME</b>
	<ul style="list-style-type: none"> <li>Press <b>SET</b>.</li> <li>Via ◀▶ <b>keys</b> choose demanded value.</li> <li>Via ▲▼ keys change choosen value.</li> </ul>

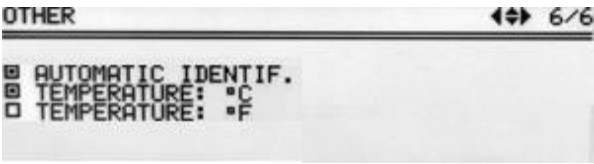
	<ul style="list-style-type: none"> <li>▪ Confirm by pressing <b>SET</b>.</li> <li>▪ Repeat above steps for other values.</li> <li>▪ Press <b>BACK</b>.</li> </ul>
Set date and time are still active even after restart of centrifuge.	



## 9.7 Language

Changing menu language	MENU / CONFIGURATION / <b>LANGUAGE</b>
	<ul style="list-style-type: none"> <li>▪ Via ▲▼ keys choose demanded menu language</li> <li>▪ Mark it by pressing <b>SET</b>.</li> </ul>

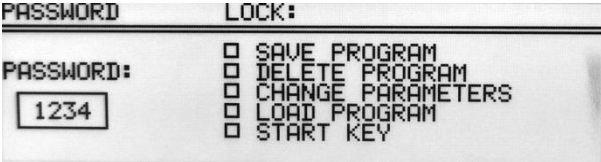
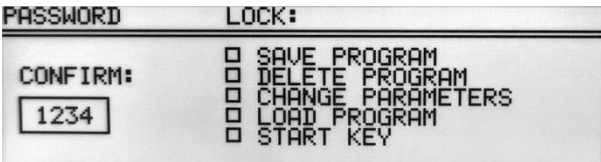
## 9.8 Other

Rotor automatic identification	MENU / CONFIGURATION / <b>OTHER</b>
 	<p>Thanks to the automatic rotor identification, the centrifuge automatically identifies the rotor in the chamber. Rotor identification is indicated by the message.</p> <p>When the function is deactivated, it is necessary to manually select the desired rotor as described in "6.7 Choosing rotors".</p> <p>The AUTOMATIC IDENTIF. is turned on by default.</p> <p>To enable/unable the function:</p> <ul style="list-style-type: none"> <li>▪ Via ▲▼ keys choose</li> <li>▪ <input type="checkbox"/> AUTOMATIC IDENTIF.</li> <li>▪ Press <b>SET</b> (<input type="checkbox"/> change to <input checked="" type="checkbox"/> or conversely) .</li> </ul> <p>Autoidentification is not active for work in the loaded program mode.</p>

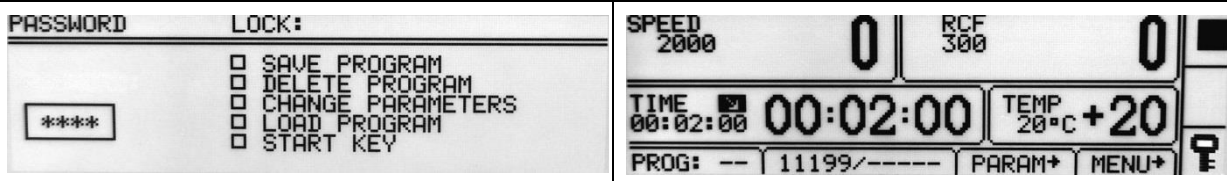
Choice of temperature unit	MENU / CONFIGURATION / OTHER
	<p>The TEMPERATURE in °C is turned on by default.</p> <p>To change the temperature unit:</p> <ul style="list-style-type: none"> <li>Via ▲▼ keys select unit</li> <li>Confirm by pressing SET.</li> </ul>

TEMPERATURE IN °C	TEMPERATURE IN °F
	

## 9.9 Password

Setting up password	MENU / PASSWORD
<p>To prevent from an unauthorized use, a <b>PASSWORD</b> can be set.</p> <p><b>Note:</b> No PASSWORD is set by default.</p> <p>The PASSWORD can be set as follows when the rotor is at a standstill.</p>	
	<ul style="list-style-type: none"> <li>Press the ▲▼ keys until "PASSWORD:" blinks.</li> <li>Press SET.</li> <li>Press ►</li> <li>With ◀▶ keys set the valid place of the PASSWORD. With ▲▼ keys set correct value.</li> <li>Repeat above steps for all places.</li> <li>Press SET.</li> </ul>
	<ul style="list-style-type: none"> <li>As a confirmation repeat instructions described above.</li> </ul>

When the **PASSWORD** is set, the Key sign is displayed in the **CODE** zone. It is also displayed in the main menu (lower right corner of the screen).



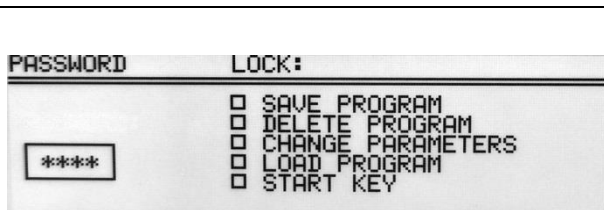
From then on, access to the **MENU** is possible after entering the password.

In case of incorrect password, it will show message: **ACCESS DENIED!**

To delete the **PASSWORD**, "0000" must be set.

If the **PASSWORD** is forgotten, the emergency code "7654" should be used to clear password and remove all locks.

### Setting up locks



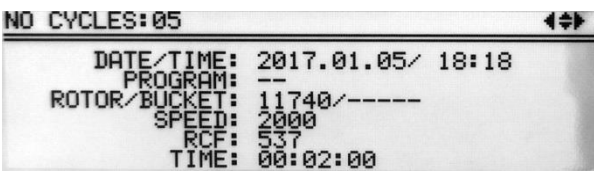
- With ▲▼ keys choose a lock.
- Mark a lock by pressing **SET**.
- Repeat above steps for desired locks.
- Leave menu with **BACK** key.

	Disabled*	description
<b>SAVE PROGRAM</b>	<b>SAVE</b> button	<ul style="list-style-type: none"> <li>▪ no programs can be saved</li> </ul>
<b>DELETE PROGRAM</b>	<b>DELETE</b> button	<ul style="list-style-type: none"> <li>▪ no programs can be deleted</li> <li>▪ saving programs on position where one was already stored is disabled</li> </ul>
<b>CHANGE PARAMETERS</b>	fields: 	<ul style="list-style-type: none"> <li>▪ parameters can not be modified</li> </ul>
<b>LOAD PROGRAM</b>	<b>LOAD</b> button	<ul style="list-style-type: none"> <li>▪ no programs can be called up</li> </ul>

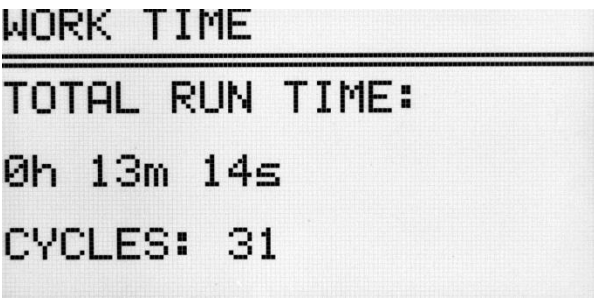
START KEY	START key	<ul style="list-style-type: none"> <li>centrifugation can not be started</li> </ul>
-----------	-----------	---

\* Executing disabled procedures is only possible after entering the correct

### 9.10 Last 10 cycles

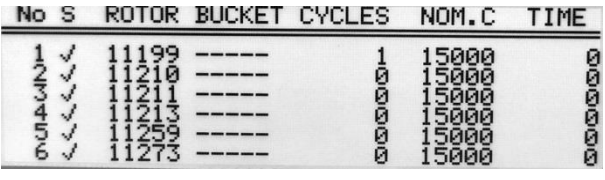
Information concerning parameters of last 10 centrifuging cycles.	MENU / LAST 10 CYCLES
	<ul style="list-style-type: none"> <li>Number of cycle can be changed by ◀▶ keys.</li> <li>The list can be scrolled using ▲▼ keys.</li> <li>To exit press SET/BACK key</li> </ul>

### 9.11 Work time

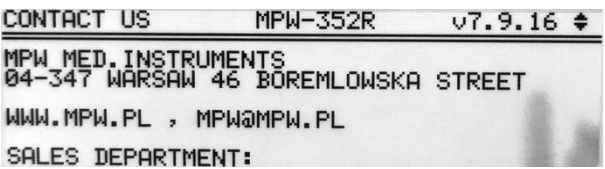
Total working time of centrifuge, and quantity of working cycles.	MENU / WORK TIME
	<p>In the <b>WORK TIME</b> menu the following statistics are displayed:</p> <ul style="list-style-type: none"> <li>total working (centrifugation) time</li> <li>working cycles counter</li> </ul>

### 9.12 Rotor runtime

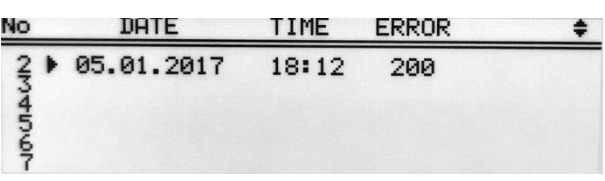
Information about the time of centrifuging and of the quantity of the working cycles of each rotor. The table also contains icons warning of the duty of execution of validation.	MENU / ROTOR RUNTIME
---	----------------------

 <pre> No S  ROTOR  BUCKET  CYCLES  NOM.C  TIME ----- 1 ✓  11199  -----  1    15000  0 2 ✓  11210  -----  0    15000  0 3 ✓  11211  -----  0    15000  0 4 ✓  11213  -----  0    15000  0 5 ✓  11259  -----  0    15000  0 6 ✓  11273  -----  0    15000  0 </pre>	<ul style="list-style-type: none"> <li>▪ The list can be scrolled using ▲▼ keys.</li> <li>▪ To exit press <b>BACK</b> key.</li> </ul> <p>Symbols:</p> <ul style="list-style-type: none"> <li>✓ – more than 100 cycles left</li> <li>! – less than 100 cycles left</li> <li>■ – worn rotor</li> </ul>
---	--

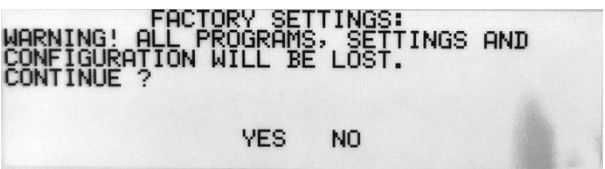
### 9.13 Contact us

Information about the type of the centrifuge, firmware version, and contact details.	MENU / <b>CONTACT US</b>
 <pre> CONTACT US      MPW-352R      v7.9.16 ----- MPW MED. INSTRUMENTS 04-347 WARSAW 46 BOREMLOWSKA STREET WWW.MPW.PL , MPW@MPW.PL SALES DEPARTMENT: </pre>	<ul style="list-style-type: none"> <li>▪ The list can be scrolled using ▲▼ keys.</li> <li>▪ To exit press <b>BACK</b> key.</li> </ul>

### 9.14 Diagnostics


Information about errors arisen in working of the centrifuge (for service).	MENU / <b>DIAGNOSTICS</b>
 <pre> No  DATE      TIME      ERROR ----- 2  05.01.2017  18:12    200 </pre>	<p><b>Intended for service purposes!</b></p>

### 9.15 Factory settings


Restoring factory settings.	MENU/ <b>FACTORY SETTINGS</b>
<b>All settings of user programs will be deleted.</b>	
 <pre> FACTORY SETTINGS: WARNING! ALL PROGRAMS, SETTINGS AND CONFIGURATION WILL BE LOST. CONTINUE ?  YES  NO </pre>	<ul style="list-style-type: none"> <li>▪ Via ◀▶ keys choose <b>YES</b> or <b>NO</b>.</li> <li>▪ Confirm by pressing <b>SET</b>.</li> </ul>

## 10 Maintenance


### 10.1 *Cleaning of the centrifuge*

	<ul style="list-style-type: none"><li>▪ <b>Pull the mains plug before cleaning.</b></li><li>▪ <b>Before any cleaning or decontamination process other than that is recommended by the manufacturer, the user has to ask the manufacturer if the planned process does not damage the device</b></li><li>▪ For cleaning, water with soap or other water soluble <b>mild detergent</b> shall be used.</li><li>▪ One should avoid corrosive and aggressive substances. It is prohibited to use alkaline solutions, inflammable solvents or agents containing abrasive particles.</li><li>▪ Do not lubricate the centrifuge motor shaft.</li><li>▪ The unused centrifuge should have cover opened.</li></ul> <p><b>Once a week</b></p> <ul style="list-style-type: none"><li>▪ Using wiping cloth, remove condensate or residues of the products from the rotor chamber.</li></ul> <p><b>Once a month</b></p> <ul style="list-style-type: none"><li>▪ Check the rotor clamping thread. In case of damage, replaced it.</li><li>▪ Check the centrifuging chamber whether it is damaged. In case of damage it can not be longer put into operation. Notify authorized service workshop.</li></ul>
---	--

### 10.2 *Maintenance of centrifuge elements*


	<ul style="list-style-type: none"><li>▪ The rotor pins shall be always lubricated with petroleum jelly.</li><li>▪ In this way, the uniform deflection of the buckets and quiet centrifuge operation is ensured.</li></ul>
---	---

#### **Cleaning of the accessories**

	<ul style="list-style-type: none"><li>▪ In order to ensure safe operation one shall carry out in <b>regular</b> way periodical maintenance of the accessories.</li><li>▪ Rotors, buckets and round carriers have to withstand high stresses originating from the centrifugal force. Chemical reactions as well as corrosion (combination of variable pressure and chemical reactions) can cause destruction of metals. Hard to observe surface cracks increase gradually and weaken material without visible symptoms.</li></ul>
---	--

	<ul style="list-style-type: none"> <li>▪ In case of observation of surface damage, crevice or other change, as well as the corrosion, the given part (rotor, bucket, etc.) shall be immediately replaced.</li> <li>▪ Clamping rotor, containers and reducer inserts must be cleaned regularly to prevent corrosion.</li> <li>▪ Cleaning of the accessories shall be carried out outside of the centrifuge <b>once every week</b> or still better after each use. For cleaning them one should use neutral agent of pH value 6÷8. It is forbidden to use alkaline agent of <b>pH &gt; 8</b>. Then, those parts shall be dried using soft fabric or in the chamber drier at ca. 50°C.</li> <li>▪ Angle rotor should be placed on a fabric with holes facing down, for effective drying.</li> <li>▪ Do not use bleach on plastic parts of the rotor.</li> <li>▪ In this way, the useful service life of the device is substantially increased and susceptibility to corrosion is diminished. Accurate maintenance increases the service life as well and protects against premature rotor failures.</li> </ul> <p>Do not use bleach on plastic parts of the rotor.</p> <p>According to laboratory standards, minimize the immersion time in each solution.</p> <ul style="list-style-type: none"> <li>▪ Especially prone to the corrosion are parts made of aluminium.</li> <li>▪ Corrosion and damages resulting from insufficient maintenance could not be subject of claims lodged against the manufacturer.</li> <li>▪ The unused rotor should have the lid removed.</li> </ul>
--	--

- **HS** accessories maintenance.

	<ul style="list-style-type: none"> <li>▪ Check the general condition of seals.</li> <li>▪ Make sure that rubber O-rings are lightly coated with silicone grease. Use high vacuum grease, e.g. type „C” by LUBRINA.</li> <li>▪ In order to maintain hermetic sealing, it is recommended to replace the sealing rings after each autoclaving.</li> <li>▪ Store hermetically sealed rotors and buckets with the lids removed.</li> </ul>
---	---



### 10.3 Sterilization

#### Plastics - legend to abbreviations

<b>PS</b>	polystyrene	<b>ECTFE</b>	ethylene/chlorotrifluoroethylene
<b>SAN</b>	styrene-acrylonitrile	<b>ETFE</b>	ethylene/tetrafluoroethylene
<b>PMMA</b>	polymethyl methacrylate	<b>PTFE</b>	polytetrafluoroethylene
<b>PC</b>	polycarbonate	<b>FEP</b>	tetrafluoroethylene/perfluoropropylene
<b>PVC</b>	polyvinyl chloride	<b>PFA</b>	tetrafluoroethylene/perfluoroalkylvinylether
<b>POM</b>	acetal polyoxymethylenel	<b>FKM</b>	fluorcarbon rubber
<b>PE-LD</b>	low density polyethylene	<b>EPDM</b>	ethylene propylene diene
<b>PE-HD</b>	high density polyethylene	<b>NR</b>	natural rubber
<b>PP</b>	polypropylene	<b>SI</b>	silicon rubber
<b>PMP</b>	polymethylpentene		

One can use all standard disinfectants. Centrifuges and devices are made of different materials, one should consider their variety.

	radiation $\beta$ radiation $\gamma$ 25 kGy	$C_2H_4O$ (ethylene oxide)	formalin, ethanol
<b>PS</b>	●	○	●
<b>SAN</b>	○	●	●
<b>PMMA</b>	●	○	●
<b>PC</b>	●	●	●
<b>PVC</b>	○	●	●
<b>POM</b>	●	●	●
<b>PE-LD</b>	●	●	●
<b>PE-HD</b>	●	●	●
<b>PP</b>	●	●	●
<b>PMP</b>	●	●	●
<b>ECTFE, ETFE</b>	○	●	●
<b>PTFE</b>	○	●	●
<b>FEP, PFA</b>	○	●	●
<b>FKM</b>	○	●	●
<b>EPDM</b>	○	●	●
<b>NR</b>	○	●	●
<b>SI</b>	○	●	●

- may be used
- cannot be used

In the centrifuge, disinfectants and cleaning agents generally used in medical care should be used (e.g. Aerodesina-2000, Lysoformin 3000, Melseptol, Melsept SF, Sanepidex, Cutasept F).

### 10.3.1 Autoclaving

- Rotors, buckets and round carriers can be sterilized in autoclave with temperature 121°C during 20 min (215 kPa), unless otherwise specified in the OPTIONAL ACCESSORY.
- During sterilization (autoclaved) by means of steam one should to consider temperature resistance of individual materials.
- Deformation of the accessories (carriers or lids made of plastic) may occur during autoclaving.
- Do not autoclave disposable materials (e.g. tubes, cyto-container).
- The life of the accessory depends on the frequency of autoclaving and use.
- Autoclaving reduce lifespan of plastic components. They should be replaced if any signs of damage are visible, including a change in colour or shape or when leakage etc.
- Pressure in closed containers can cause plastic deformation or explosion.
- Prior to autoclaving the rotors and accessories, thoroughly wash and rinse with distilled water.
- Never exceed the permissible autoclaving temperature and time.
- If you want to keep the hermetic seals, replace the sealing rings after each autoclave.

#### Chemical resistance of plastics

	autoclaving 121 °C, 20 min		autoclaving 121 °C, 20 min
PS	○	PMP	●
SAN	○	ECTFE, ETFE	●
PMMA	○	PTFE	●
PC	●	FEP, PFA	●
PVC	○ <sup>1)</sup>	FKM	●
POM	●	EPDM	●
PE-LD	○	NR	○
PE-HD	○	SI	●
PP	●		

- may be used
- cannot be used

1) Except PVC hoses which are resistant to the steam sterilization in the temperature 121°C.

## 10.4 Chemical resistance



### Chemical resistance of plastics

	aldehydes	cyclic alcohols	esters	ether	ketones	strong or concentrated acids	weak or diluted acids	oxidizing substances	cyclic hydrocarbons	ahs	haloid hydrocarbons	alkalis
PS	○	●	○	○	○	○/●	○/●	○	○	○	○	●
SAN	○	●	○	○	○	○	○/●	○	○	○	○	●
PMMA	○/●	●	○	○	○	○	○/●	○	○/●	○	○	○
PC	○/●	●	○	○	○	○	○/●	○	○/●	○	○	○
PVC	○	●	○	○	○	●	●	○	●	○	○	●
POM	○/●	●	○	●	●	○	○	○	●	●	●	●
PE-LD		●	●	●	○/●	●	●	○	●	●	●	●
PE-HD	●	●	○/●	○/●	○/●	●	●	○	●	○/●	○/●	●
PP	●	●	○/●	○/●	○/●	●	●	○	●	○/●	○/●	●
PMP	○/●	●	○/●		○/●	●	●	○	○/●	○	○	●
ECTFE	●	●	●	●	○	●	●	●	●	●	●	●
ETFE												
PTFE		●										
FEP	●		●	●	●	●	●	●	●	●	●	●
PFA												
FKM	●	○	○	○	○	○	●	○/●	○/●	○/●	○/●	○/●
EPDM	●	●	○/●	○	○/●	●	●	○/●	○	○	○	●
NR	○/●	●	○/●	○	○	○	○/●	○	○	○	○	●
SI	○/●	●	○/●	○	○	○	○/●	○	○	○	○	○/●

●	very good	Permanent action of the substance does not cause damage through 30 days. The material is able to be resistant through years
○/●	good to limited	Continuous action of the substance causes insignificant and partly reversible damage through the period of 7-30 days (e.g. puffing up, softening, reduced mechanical durability, discolouring).
○	limited	The material should not have the continuous contact with the substance. The immediate occurrence of damage is possible (e.g. the loss of mechanical durability, deformation, discolouring, bursting, dissolving).








Rubber inserts shall be exactly cleaned or possibly replaced. Centrifuges and accessories are made of different materials.

Do not use bleach on plastic parts of the rotor.

	<b>DANGER!</b> MPW accessorises are not biotight. For centrifuging infectious materials it is necessary to use hermetically closed tubes meeting demands of biotightness, in order to prevent germs migration into the centrifuge and beyond it.
	User is responsible for proper disinfections of the centrifuge, if some dangerous material was spilled inside or outside of the centrifuge. During the above mentioned works one must wear safety gloves.

## 11 Troubleshooting

Majority of faults could be removed by switching the centrifuge OFF and then ON. After switching the centrifuge ON, there shall be displayed parameters of the recently implemented program and sound signals comprising four successive tones shall be generated. In case of short-duration power failure the centrifuge terminates the cycle and displays PROGRAM ERROR code.

problem	question	remedy
<b>Centrifuge does not start</b>	<i>Is supply cable plugged into mains?</i>	<i>Plugs supply cable correctly.</i>
	<i>Is master switch ON?</i>	<i>Switch ON power supply.</i>
<b>Motor error is displayed</b>		Call service.
<b>Centrifuge does not start</b>  (indications are proof for cycle in progress and motor does not start)	<i>Is  symbol displayed?</i>	Wait till rotor stops and the  symbol goes off.
	<i>Is  symbol displayed?</i>	Close cover.  symbol must switch off.
	<i>Is  symbol blinking?</i>	Centrifugation cycle in progress, press STOP key or wait till cycle ends.
<b>Centrifuge does not accelerate</b>  (unbalance error)	<i>Unequal rotor load.</i>	Centrifuge load shall be balanced.
	<i>Inclined centrifuge.</i>	Centrifuge shall be levelled.
	<i>Faulty drive (mechanical damage).</i>	Call service.
	<i>Was centrifuge displaced during operation.</i>	Switch ON the centrifuge again after opening and closing the cover.
<b>(motor error)</b>	<i>After stopping error rotor message is displayed</i>	Check if rotor number in started program is consistent with the number of the rotor installed in the centrifuge.  Check rotor status (if there are coding magnets inserted)
	<i>Centrifuge does not recognize the rotor and does not stop.</i>	Switch the centrifuge OFF, then ON and check correctness of loaded program
<b>It is not possible to open the cover</b>	<i> symbol on the display is blinking, after pressing COVER key single tone is audible</i>	Rotor is still rotating. Wait for stopping of the rotor and displaying of the  symbol.
	<i>The sensor is connected correctly, and the error is still applying.</i>	Call service.
<b>Mains failure during run</b>	<i>The message will be displayed on the display about the decay of tension.</i>	Wait for stopping of the rotor, clear the error by pressing the SET key.
<b>Temperature sensor error</b>	<i>The overheating message will be displayed.</i>	Switch the centrifuge OFF, then ON.
		Call service.
<b>Error of the exceeding the temperature (50°C) in the chamber</b>	<i>The overheating message will be displayed.</i>	Call service.

## 11.1 Messages

Screen messages that may occur during operation.	
MESSAGE	EXPLANATION
"SPEED OF ROTOR" "IDENTIFICATION <> 90 RPM"	Please try start centrifuging again, if error still occur, contact manufacturer's authorized service.
"IMBALANCE FAST STOP !" "PLEASE REMOVE CAUSE" "THEN RESTART"	Rotor is not balanced correctly, please balance rotor.
"NO ROTOR OR IDENTIFICATION" "SENSOR DAMAGED !"	Make sure, is rotor mounted in the centrifuge chamber. If it is right contact manufacturer's authorized service.
"INCORRECT ROTOR NUMBER !"	Change rotor number in centrifuge settings or use autoidentification.
"WRONG DIRECTION OF ROTATION" "OR UNKNOWN ROTOR !"	Make sure if correct rotor for centrifuge is mounted. List of accessories is described in chapter 15.
"PLEASE CLOSE THE LID" "HAND !"	Necessity of manually closing the lid.
"ROTOR STOPPING !" "Please wait..."	Initializing after mains failure with rotating rotor, wait until rotor stop.

MESSAGE
"OVERHEATING MOTOR !" "INVERTER ERROR !"
"INVERTER SERIAL BUS ERROR !"
"TEMPERATURE SENSOR ERROR"
"PRESSURE CONTROL FAILURE!"
"OPENING COVER in RUN!"
"SPEED METER ERROR"
"I2C BUS ERROR"
"OVERHEATING CENTRIFUGE !"
"ROTOR OVERSPEED !"
"COVER LOCK MALFUNCTION !"

## 11.2 Emergency cover release



### EMERGENCY COVER RELEASE

You can manually open the lid (eg. in case of power failure). To do this, insert the key into the emergency opening of the cover (Cat. No. 17162) into the hole on the right side of the chassis and then push it until you release the lock of the lock and open the cover.

**CAUTION!** *The cover can be open the emergency only when the rotor is at rest. You should check this by see inside the centrifuge using the viewfinder provided in the lid.*

## 12 Guarantee

Manufacturer grants to the Buyer the guarantee on conditions specified in the Guarantee Certificate. Buyer forfeits the right to guarantee repair when using the device inconsistently with the User manual provisions, when damage results from the User's fault.

Repairs should be carried out in authorized service workshops, granted with the MPW Certificate.

The centrifuge shall be sent to repair after decontaminating disinfections. Information about authorized service workshops could be obtained from the Manufacturer.



- Guarantee period amounts to 24 months (unless otherwise specified in the purchase documents).
- Guarantee conditions are described in guarantee card..
- The service life of the centrifuge specified by the manufacturer amounts to 10 years.
- After 24 months from the start of the warranty period (date of purchase), a technical inspection of the centrifuge should be carried out (validation) by an authorized service of the manufacturer. Subsequent inspections should be carried out at annual intervals.
- Maximum period of storage of not used centrifuge amounts to 1 year. After this period, a service authorized by manufacturer should carry out technical inspection of the centrifuge.
- Manufacturer reserves the right to make technical changes in manufactured products.

## 13 Disposal



- When you are disposing the device, the respective statutory rules must be observed.
- Pursuant to guideline 2002/96/EC (WEEE), all devices supplied after August 13, 2005, may not be disposed as part of domestic waste.
- The device belongs to 8th group (medical devices) and is categorized in business to business field.
- The icon of the crossed-out trash can shows that the device may not be disposed as part of domestic waste. The waste disposal guidelines of the individual EC countries might vary. If necessary, contact your supplier.



## 14 Manufacturer's info

"MPW MED. INSTRUMENTS" SPÓŁDZIELNIA PRACY

Boremlowska 46 Street

04-347 Warsaw

tel. (+48) 22 610 56 67 (sales department - POLAND)  
(+48) 22 879 70 46 (sales department - outside POLAND)  
(+48) 22 610 81 07 (service)

fax: (+48) 22 610 55 36

e-mail: mpw@mpw.pl

website: www.mpw.pl

E0008530W - registration number given by Chief Inspectorate Of Environmental Protection

PL/CA01-01782 - identification number given by Office for Registration of Medicinal Products, Medical Devices and Biocidal Products.

## Distributor's info

**DISTRIBUTOR:**



## 15 ANNEXES

**A. Wyposażenie dodatkowe/Optional accessories****MPW-352/R/RH****WIRNIK / ROTOR****PARAMETRY WIRNIKA / ROTOR PARAMETERS****POJEMNIK/BUCKET****WKŁADKA / ADAPTER**

[liczba probówek na wirnik/tubes per rotor] PROBÓWKA / TUBE

**11199****RPM 18000, RCF 24270, Rmax 67,  $\alpha$  45****bez pojemnika/without bucket****14084**[12] 15127 0,5 ml probówka PCR (7,8 x 31 mm)  
0,5 ml PCR tube (7,8 x 31 mm)**14126**[12] 15124 0,4 ml probówka PCR (5,7 x 48,6 mm)  
0,4 ml PCR tube (5,7 x 48,6 mm)**14133**[12] 15125 0,2 ml probówka PCR (6 x 21,6 mm)  
0,2 ml PCR tube (6 x 21,6 mm)**bez wkładki/without adapter**[12] \* 2-1,5 ml probówka (10,8x41,8 mm), Eppendorf®; [15011], 2 ml (10,8x41,8 mm); [15128], 1,5ml (10,8x40,5 mm)  
2-1,5 ml tube (10,8x41,8 mm), Eppendorf®; [15011], 2 ml (10,8x41,8 mm); [15128], 1,5ml (10,8x40,5 mm)**11210****RPM 5000, RCF 3997, Rmax 143,  $\alpha$  30****13080****14082**

[24] \* BD Vacutainer® (13 x 100 mm), (4-7 ml)

[24] \* Greiner Vacuette® (13 x 100 mm), (3,5-6 ml)

[24] \* Sarstedt S-Monovette® (11 x 92 mm), (4,5; 5 ml)

[24] 15054 6 ml probówka z pokrywką (11,5 x 92 mm), Sarstedt®  
6 ml tube with cap (11,5 x 92 mm), Sarstedt®[24] 15119 7 ml probówka szklana (12 x 100 mm)  
7 ml glass tube (12 x 100 mm)**bez wkładki/without adapter**

[24] \* BD Vacutainer® (16 x 100 mm), (2,5-11 ml)

[24] \* Greiner Vacuette® (16 x 100 mm), (7-9 ml)

[24] \* Sarstedt S-Monovette® (15 x 92 mm), (7,5; 8,2; 8,5 ml)

[24] \* Sarstedt S-Monovette® (16 x 92 mm), (9; 10 ml)

[24] 15046 14 ml probówka z pokrywką (16,8 x 113,7 mm), Sarstedt®  
14 ml tube with cap (16,8 x 113,7 mm), Sarstedt®

[24] 15048 15 ml Thermo Nalgene® (16 x 113 mm)

15 ml Thermo Nalgene® (16 x 113 mm)

[24] 15053 10 ml probówka z pokrywką (16 x 106 mm)  
10 ml tube with cap (16 x 106 mm)[24] 15118 10 ml probówka szklana (16 x 100 mm)  
10 ml glass tube (16 x 100 mm)[24] \* 15 ml probówka z dnem stożkowym z zakrętką (17 x 120 mm), Falcon®; [15050], 15ml (17 x 120 mm)  
15 ml tube, conical bottom, with cap (17 x 120 mm), Falcon®; [15050] 15ml Sarstedt®(17 x 120 mm)

**A. Wyposażenie dodatkowe/Optional accessories****13081****14082**

[24]	*	BD Vacutainer® (13 x 75 mm), (1,6-5,3 ml)
[24]	*	Greiner Vacuette® (13 x 75 mm), (1-4,5 ml)
[24]	*	Sarstedt S-Monovette® (11 x 66 mm), (1,6; 2; 2,7; 3; 3,1 ml)
[24]	*	Sarstedt S-Monovette® (13 x 65 mm), (2,6; 2,9; 3,4; 3,8 ml)
[24]	*	Sarstedt S-Monovette® (13 x 75 mm), (2,7; 3; 4,3 ml)
[24]	15120	5 ml probówka szklana (12 x 75 mm) 5 ml glass tube (12 x 75 mm)
<b>bez wkładki/without adapter</b>		
[24]	*	Sarstedt S-Monovette® (15 x 75 mm), (4; 4,3; 5,5 ml)
[24]	*	10 ml Thermo Nalgene® Oak Ridge (16 x 81,5 mm)
[24]	15121	10 ml probówka z dnem okrągłym i pokrywką (17 x 70 mm) 10 ml tube, round bottom, with cap (17 x 70 mm)

**11211****RPM 5500, RCF 4498, Rmax 133,  $\alpha$  30****13276****14035**

[10]	15046	14 ml probówka z pokrywką (16,8 x 113,7 mm), Sarstedt® 14 ml tube with cap (16,8 x 113,7 mm), Sarstedt®
[10]	15048	15 ml Thermo Nalgene® (16 x 113 mm) 15 ml Thermo Nalgene® (16 x 113 mm)
[10]	15053	10 ml probówka z pokrywką (16 x 106 mm) 10 ml tube with cap (16 x 106 mm)
[10]	15118	10 ml probówka szklana (16 x 100 mm) 10 ml glass tube (16 x 100 mm)

**14036**

[10]	*	BD Vacutainer® (13 x 100 mm), (4-7 ml)
[10]	*	Greiner Vacuette® (13 x 100 mm), (3,5-6 ml)
[10]	15054	6 ml probówka z pokrywką (11,5 x 92 mm), Sarstedt® 6 ml tube with cap (11,5 x 92 mm), Sarstedt®
[10]	15119	7 ml probówka szklana (12 x 100 mm) 7 ml glass tube (12 x 100 mm)

**14043**

[10]	*	Greiner Vacuette® (13 x 75 mm), (1-4,5 ml)
[10]	*	Sarstedt S-Monovette® (13 x 75 mm), (2,7; 3; 4,3 ml)
[10]	*	Sarstedt S-Monovette® (13 x 90 mm), (4,9; 5,6 ml)
[10]	15120	5 ml probówka szklana (12 x 75 mm) 5 ml glass tube (12 x 75 mm)
[10]	15419	5 ml probówka z korkiem (12 x 85 mm), Sarstedt® 5 ml tube with cap (12 x 85 mm), Sarstedt®

**14071**

[10]	*	28 ml Thermo Nalgene® Oak Ridge (25,4 x 101,8 mm)
[10]	15055	30 ml probówka z pokrywką (25,4 x 103,2 mm) 30 ml tube with cap (25,4 x 103,2 mm)
[10]	15056	30 ml Thermo Nalgene® Oak Ridge (25,5 x 94,3 mm) 30 ml Thermo Nalgene® Oak Ridge (25,5 x 94,3 mm)
[10]	15117	25 ml probówka szklana (25 x 100 mm) 25 ml glass tube (25 x 100 mm)
[10]	15424	30 ml probówka z pokrywką (25,5 x 94 mm), Nalgene® 30 ml tube with cap (25,5 x 94 mm), Nalgene®

**14073**

[10]	*	Greiner Vacuette® (16 x 100 mm), (7-9 ml)
[10]	*	Sarstedt S-Monovette® (15 x 92 mm), (7,5; 8,2; 8,5 ml)
[10]	*	BD Vacutainer® (16 x 100 mm), (2,5-11 ml)
[10]	*	Sarstedt S-Monovette® (16 x 92 mm), (9; 10 ml)
[10]	15046	14 ml probówka z pokrywką (16,8 x 113,7 mm), Sarstedt® 14 ml tube with cap (16,8 x 113,7 mm), Sarstedt®
[10]	15053	10 ml probówka z pokrywką (16 x 106 mm) 10 ml tube with cap (16 x 106 mm)
[10]	15118	10 ml probówka szklana (16 x 100 mm) 10 ml glass tube (16 x 100 mm)

**14089**

[10]	*	15 ml probówka z dnem stożkowym z zakrętką (17 x 120 mm), Falcon®; [15050], 15ml (17 x 120 mm) 15 ml tube, conical bottom, with cap (17 x 120 mm), Falcon®; [15050] 15ml Sarstedt®(17 x 120 mm)
------	---	--

<b>A. Wyposażenie dodatkowe/Optional accessories</b>	
<b>14248</b>	
[10]	15055 30 ml probówka z pokrywką (25,4 x 103,2 mm) 30 ml tube with cap (25,4 x 103,2 mm)
[10]	15117 25 ml probówka szklana (25 x 100 mm) 25 ml glass tube (25 x 100 mm)
<b>14089+14868</b>	
[10]	* 5 ml probówka z korkiem wciskany (17 x 54,2 mm), Eppendorf® 5 ml tube with snap cap (17 x 54,2 mm), Eppendorf®
[10]	* 5 ml probówka z korkiem zakręcany (17 x 66 mm), Eppendorf® 5 ml tube with screw cap (17 x 66 mm), Eppendorf®
<b>bez wkładki/without adapter</b>	
[10]	15051 50 ml Thermo Nalgene® Oak Ridge (28,8 x 106,7 mm) 50 ml Thermo Nalgene® Oak Ridge (28,8 x 106,7 mm)
[10]	* 50 ml probówka z dnem stożkowym z zakrętką (30 x 117 mm), Falcon®; [15052] 50ml (30 x 117mm) 50 ml tube, conical bottom, with cap (30 x 117 mm), Falcon®; [15052] 50ml Sarstedt® (30 x 117 mm)
[10]	* 50 ml probówka z dnem stożkowym bez rantu (30 x 115 mm), Greiner® 50 ml tube, conical bottom, without skirt (30 x 115 mm), Greiner®
[10]	* 50 ml probówka Advanced Oak Ridge (29x102 mm), Herolab® nr 25 32 11 50 ml tube, Advanced Oak Ridge (29 x 102 mm), Herolab® no. 25 32 11
<b>13278C</b>	
<b>14035</b>	
[10]	15046 14 ml probówka z pokrywką (16,8 x 113,7 mm), Sarstedt® 14 ml tube with cap (16,8 x 113,7 mm), Sarstedt®
[10]	15048 15 ml Thermo Nalgene® (16 x 113 mm) 15 ml Thermo Nalgene® (16 x 113 mm)
[10]	15053 10 ml probówka z pokrywką (16 x 106 mm) 10 ml tube with cap (16 x 106 mm)
[10]	15118 10 ml probówka szklana (16 x 100 mm) 10 ml glass tube (16 x 100 mm)
<b>14036</b>	
[10]	15054 6 ml probówka z pokrywką (11,5 x 92 mm), Sarstedt® 6 ml tube with cap (11,5 x 92 mm), Sarstedt®
[10]	15119 7 ml probówka szklana (12 x 100 mm) 7 ml glass tube (12 x 100 mm)
<b>14043</b>	
[10]	* Greiner Vacuette® (13 x 75 mm), (1-4,5 ml)
[10]	15120 5 ml probówka szklana (12 x 75 mm) 5 ml glass tube (12 x 75 mm)
[10]	15419 5 ml probówka z korkiem (12 x 85 mm), Sarstedt® 5 ml tube with cap (12 x 85 mm), Sarstedt®
<b>14071</b>	
[10]	* 28 ml Thermo Nalgene® Oak Ridge (25,4 x 101,8 mm)
[10]	15055 30 ml probówka z pokrywką (25,4 x 103,2 mm) 30 ml tube with cap (25,4 x 103,2 mm)
[10]	15056 30 ml Thermo Nalgene® Oak Ridge (25,5 x 94,3 mm) 30 ml Thermo Nalgene® Oak Ridge (25,5 x 94,3 mm)
[10]	15117 25 ml probówka szklana (25 x 100 mm) 25 ml glass tube (25 x 100 mm)
[10]	15424 30 ml probówka z pokrywką (25,5 x 94 mm), Nalgene® 30 ml tube with cap (25,5 x 94 mm), Nalgene®
<b>14073</b>	
[10]	* Greiner Vacuette® (16 x 100 mm), (7-9 ml)
[10]	* Sarstedt S-Monovette® (15 x 92 mm), (7,5; 8,2; 8,5 ml)
[10]	* BD Vacutainer® (16 x 100 mm), (2,5-11 ml)
[10]	* Sarstedt S-Monovette® (16 x 92 mm), (9; 10 ml)
[10]	15046 14 ml probówka z pokrywką (16,8 x 113,7 mm), Sarstedt® 14 ml tube with cap (16,8 x 113,7 mm), Sarstedt®
[10]	15053 10 ml probówka z pokrywką (16 x 106 mm) 10 ml tube with cap (16 x 106 mm)
[10]	15118 10 ml probówka szklana (16 x 100 mm) 10 ml glass tube (16 x 100 mm)
<b>14089</b>	
[10]	* 15 ml probówka z dnem stożkowym z zakrętką (17 x 120 mm), Falcon®; [15050], 15ml (17 x 120 mm) 15 ml tube, conical bottom, with cap (17 x 120 mm), Falcon®; [15050] 15ml Sarstedt®(17 x 120 mm)
<b>14248</b>	
[10]	15055 30 ml probówka z pokrywką (25,4 x 103,2 mm) 30 ml tube with cap (25,4 x 103,2 mm)
[10]	15117 25 ml probówka szklana (25 x 100 mm) 25 ml glass tube (25 x 100 mm)
<b>14089+14868</b>	
[10]	* 5 ml probówka z korkiem wciskany (17 x 54,2 mm), Eppendorf® 5 ml tube with snap cap (17 x 54,2 mm), Eppendorf®

\* probówka niedostępna w ofercie MPW lub dostępny odpowiednik (np:[15050]), patrz kolumna z prawej  
tube is not offered by MPW or equivalent is available (e.g. [15050]), see column on the right

<b>A. Wyposażenie dodatkowe/Optional accessories</b>	
<b>bez wkładki/without adapter</b>	
[10] 15051	50 ml Thermo Nalgene® Oak Ridge (28,8 x 106,7 mm) 50 ml Thermo Nalgene® Oak Ridge (28,8 x 106,7 mm)
[10] *	50 ml probówka z dnem stożkowym z zakrętką (30 x 117 mm), Falcon®; [15052] 50ml (30 x 117mm) 50 ml tube, conical bottom, with cap (30 x 117 mm), Falcon®; [15052] 50ml Sarstedt® (30 x 117 mm)
[10] *	50 ml probówka z dnem stożkowym bez rantu (30 x 115 mm), Greiner® 50 ml tube, conical bottom, without skirt (30 x 115 mm), Greiner®
[10] *	50 ml probówka Advanced Oak Ridge (29x102 mm), Herolab® nr 25 32 11 50 ml tube, Advanced Oak Ridge (29 x 102 mm), Herolab® no. 25 32 11
<b>11213</b>	
<b>RPM 5500, RCF 4227, Rmax 125, <math>\alpha</math> 30</b>	
<b>13276</b>	
<b>14035</b>	
[8] 15046	14 ml probówka z pokrywką (16,8 x 113,7 mm), Sarstedt® 14 ml tube with cap (16,8 x 113,7 mm), Sarstedt®
[8] 15048	15 ml Thermo Nalgene® (16 x 113 mm) 15 ml Thermo Nalgene® (16 x 113 mm)
[8] 15053	10 ml probówka z pokrywką (16 x 106 mm) 10 ml tube with cap (16 x 106 mm)
[8] 15118	10 ml probówka szklana (16 x 100 mm) 10 ml glass tube (16 x 100 mm)
<b>14036</b>	
[8] *	BD Vacutainer® (13 x 100 mm), (4-7 ml)
[8] *	Greiner Vacuette® (13 x 100 mm), (3,5-6 ml)
[8] 15054	6 ml probówka z pokrywką (11,5 x 92 mm), Sarstedt® 6 ml tube with cap (11,5 x 92 mm), Sarstedt®
[8] 15119	7 ml probówka szklana (12 x 100 mm) 7 ml glass tube (12 x 100 mm)
<b>14043</b>	
[8] *	Greiner Vacuette® (13 x 75 mm), (1-4,5 ml)
[8] *	Sarstedt S-Monovette® (13 x 75 mm), (2,7; 3; 4,3 ml)
[8] *	Sarstedt S-Monovette® (13 x 90 mm), (4,9; 5,6 ml)
[8] 15120	5 ml probówka szklana (12 x 75 mm) 5 ml glass tube (12 x 75 mm)
[8] 15419	5 ml probówka z korkiem (12 x 85 mm), Sarstedt® 5 ml tube with cap (12 x 85 mm), Sarstedt®
<b>14071</b>	
[8] *	28 ml Thermo Nalgene® Oak Ridge (25,4 x 101,8 mm)
[8] 15055	30 ml probówka z pokrywką (25,4 x 103,2 mm) 30 ml tube with cap (25,4 x 103,2 mm)
[8] 15056	30 ml Thermo Nalgene® Oak Ridge (25,5 x 94,3 mm) 30 ml Thermo Nalgene® Oak Ridge (25,5 x 94,3 mm)
[8] 15117	25 ml probówka szklana (25 x 100 mm) 25 ml glass tube (25 x 100 mm)
[8] 15424	30 ml probówka z pokrywką (25,5 x 94 mm), Nalgene® 30 ml tube with cap (25,5 x 94 mm), Nalgene®
<b>14073</b>	
[8] *	BD Vacutainer® (16 x 100 mm), (2,5-11 ml)
[8] *	Greiner Vacuette® (16 x 100 mm), (7-9 ml)
[8] *	Sarstedt S-Monovette® (15 x 92 mm), (7,5; 8,2; 8,5 ml)
[8] *	Sarstedt S-Monovette® (16 x 92 mm), (9; 10 ml)
[8] 15046	14 ml probówka z pokrywką (16,8 x 113,7 mm), Sarstedt® 14 ml tube with cap (16,8 x 113,7 mm), Sarstedt®
[8] 15053	10 ml probówka z pokrywką (16 x 106 mm) 10 ml tube with cap (16 x 106 mm)
[8] 15118	10 ml probówka szklana (16 x 100 mm) 10 ml glass tube (16 x 100 mm)
<b>14089</b>	
[8] *	15 ml probówka z dnem stożkowym z zakrętką (17 x 120 mm), Falcon®; [15050], 15ml (17 x 120 mm) 15 ml tube, conical bottom, with cap (17 x 120 mm), Falcon®; [15050] 15ml Sarstedt®(17 x 120 mm)
<b>14248</b>	
[8] 15055	30 ml probówka z pokrywką (25,4 x 103,2 mm) 30 ml tube with cap (25,4 x 103,2 mm)
[8] 15117	25 ml probówka szklana (25 x 100 mm) 25 ml glass tube (25 x 100 mm)
<b>14089+14868</b>	
[8] *	5 ml probówka z korkiem wciskany (17 x 54,2 mm), Eppendorf® 5 ml tube with snap cap (17 x 54,2 mm), Eppendorf®
[8] *	5 ml probówka z korkiem zakręcany (17 x 66 mm), Eppendorf® 5 ml tube with screw cap (17 x 66 mm), Eppendorf®

\* probówka niedostępna w ofercie MPW lub dostępny odpowiednik (np:[15050]), patrz kolumna z prawej  
tube is not offered by MPW or equivalent is available (e.g. [15050]), see column on the right

<b>A. Wyposażenie dodatkowe/Optional accessories</b>	
<b>bez wkładki/without adapter</b>	
[8]	15051 50 ml Thermo Nalgene® Oak Ridge (28,8 x 106,7 mm) 50 ml Thermo Nalgene® Oak Ridge (28,8 x 106,7 mm)
[8]	* 50 ml probówka z dnem stożkowym z zakrętką (30 x 117 mm), Falcon®; [15052] 50ml (30 x 117mm) 50 ml tube, conical bottom, with cap (30 x 117 mm), Falcon®; [15052] 50ml Sarstedt® (30 x 117 mm)
[8]	* 50 ml probówka z dnem stożkowym bez rantu (30 x 115 mm), Greiner® 50 ml tube, conical bottom, without skirt (30 x 115 mm), Greiner®
[8]	* 50 ml probówka Advanced Oak Ridge (29x102 mm), Herolab® nr 25 32 11 50 ml tube, Advanced Oak Ridge (29 x 102 mm), Herolab® no. 25 32 11
<b>13278C</b>	
<b>14035</b>	
[8]	15046 14 ml probówka z pokrywką (16,8 x 113,7 mm), Sarstedt® 14 ml tube with cap (16,8 x 113,7 mm), Sarstedt®
[8]	15048 15 ml Thermo Nalgene® (16 x 113 mm) 15 ml Thermo Nalgene® (16 x 113 mm)
[8]	15053 10 ml probówka z pokrywką (16 x 106 mm) 10 ml tube with cap (16 x 106 mm)
[8]	15118 10 ml probówka szklana (16 x 100 mm) 10 ml glass tube (16 x 100 mm)
<b>14036</b>	
[8]	15054 6 ml probówka z pokrywką (11,5 x 92 mm), Sarstedt® 6 ml tube with cap (11,5 x 92 mm), Sarstedt®
[8]	15119 7 ml probówka szklana (12 x 100 mm) 7 ml glass tube (12 x 100 mm)
<b>14043</b>	
[8]	* Greiner Vacuette® (13 x 75 mm), (1-4,5 ml)
[8]	15120 5 ml probówka szklana (12 x 75 mm) 5 ml glass tube (12 x 75 mm)
[8]	15419 5 ml probówka z korkiem (12 x 85 mm), Sarstedt® 5 ml tube with cap (12 x 85 mm), Sarstedt®
<b>14071</b>	
[8]	* 28 ml Thermo Nalgene® Oak Ridge (25,4 x 101,8 mm)
[8]	15055 30 ml probówka z pokrywką (25,4 x 103,2 mm) 30 ml tube with cap (25,4 x 103,2 mm)
[8]	15056 30 ml Thermo Nalgene® Oak Ridge (25,5 x 94,3 mm) 30 ml Thermo Nalgene® Oak Ridge (25,5 x 94,3 mm)
[8]	15117 25 ml probówka szklana (25 x 100 mm) 25 ml glass tube (25 x 100 mm)
[8]	15424 30 ml probówka z pokrywką (25,5 x 94 mm), Nalgene® 30 ml tube with cap (25,5 x 94 mm), Nalgene®
<b>14073</b>	
[8]	* BD Vacutainer® (16 x 100 mm), (2,5-11 ml)
[8]	* Greiner Vacuette® (16 x 100 mm), (7-9 ml)
[8]	* Sarstedt S-Monovette® (15 x 92 mm), (7,5; 8,2; 8,5 ml)
[8]	* Sarstedt S-Monovette® (16 x 92 mm), (9; 10 ml)
[8]	15046 14 ml probówka z pokrywką (16,8 x 113,7 mm), Sarstedt® 14 ml tube with cap (16,8 x 113,7 mm), Sarstedt®
[8]	15053 10 ml probówka z pokrywką (16 x 106 mm) 10 ml tube with cap (16 x 106 mm)
[8]	15118 10 ml probówka szklana (16 x 100 mm) 10 ml glass tube (16 x 100 mm)
<b>14089</b>	
[8]	* 15 ml probówka z dnem stożkowym z zakrętką (17 x 120 mm), Falcon®; [15050], 15ml (17 x 120 mm) 15 ml tube, conical bottom, with cap (17 x 120 mm), Falcon®; [15050] 15ml Sarstedt®(17 x 120 mm)
<b>14248</b>	
[8]	15055 30 ml probówka z pokrywką (25,4 x 103,2 mm) 30 ml tube with cap (25,4 x 103,2 mm)
[8]	15117 25 ml probówka szklana (25 x 100 mm) 25 ml glass tube (25 x 100 mm)
<b>14089+14868</b>	
[8]	* 5 ml probówka z korkiem wciskany (17 x 54,2 mm), Eppendorf® 5 ml tube with snap cap (17 x 54,2 mm), Eppendorf®
<b>bez wkładki/without adapter</b>	
[8]	15051 50 ml Thermo Nalgene® Oak Ridge (28,8 x 106,7 mm) 50 ml Thermo Nalgene® Oak Ridge (28,8 x 106,7 mm)
[8]	* 50 ml probówka z dnem stożkowym z zakrętką (30 x 117 mm), Falcon®; [15052] 50ml (30 x 117mm) 50 ml tube, conical bottom, with cap (30 x 117 mm), Falcon®; [15052] 50ml Sarstedt® (30 x 117 mm)
[8]	* 50 ml probówka z dnem stożkowym bez rantu (30 x 115 mm), Greiner® 50 ml tube, conical bottom, without skirt (30 x 115 mm), Greiner®
[8]	* 50 ml probówka Advanced Oak Ridge (29x102 mm), Herolab® nr 25 32 11 50 ml tube, Advanced Oak Ridge (29 x 102 mm), Herolab® no. 25 32 11

**A. Wyposażenie dodatkowe/Optional accessories****11259****RPM 15000, RCF 24400, Rmax 97,  $\phi$  45****bez pojemnika/without bucket****14084**[30] 15127 0,5 ml probówka PCR (7,8 x 31 mm)  
0,5 ml PCR tube (7,8 x 31 mm)**14126**[30] 15124 0,4 ml probówka PCR (5,7 x 48,6 mm)  
0,4 ml PCR tube (5,7 x 48,6 mm)**14133**[30] 15125 0,2 ml probówka PCR (6 x 21,6 mm)  
0,2 ml PCR tube (6 x 21,6 mm)**bez wkładki/without adapter**[30] \* 2-1,5 ml probówka (10,8x41,8 mm), Eppendorf®; [15011], 2 ml (10,8x41,8 mm); [15128], 1,5ml (10,8x40,5 mm)  
2-1,5 ml tube (10,8x41,8 mm), Eppendorf®; [15011], 2 ml (10,8x41,8 mm); [15128], 1,5ml (10,8x40,5 mm)**11273****RPM 12000, RCF 14006, Rmax 87,  $\phi$  30****bez pojemnika/without bucket****bez wkładki/without adapter**[8] 15056 30 ml Thermo Nalgene® Oak Ridge (25,5 x 94,3 mm)  
30 ml Thermo Nalgene® Oak Ridge (25,5 x 94,3 mm)[8] 15424 30 ml probówka z pokrywką (25,5 x 94 mm), Nalgene®  
30 ml tube with cap (25,5 x 94 mm), Nalgene®**11456****RPM 5000, RCF 3997, Rmax 143,  $\phi$  30****13080****14082**

[36] \* BD Vacutainer® (13 x 100 mm), (4-7 ml)

[36] \* Greiner Vacuette® (13 x 100 mm), (3,5-6 ml)

[36] \* Sarstedt S-Monovette® (11 x 92 mm), (4,5; 5 ml)

[36] 15054 6 ml probówka z pokrywką (11,5 x 92 mm), Sarstedt®  
6 ml tube with cap (11,5 x 92 mm), Sarstedt®[36] 15119 7 ml probówka szklana (12 x 100 mm)  
7 ml glass tube (12 x 100 mm)**bez wkładki/without adapter**

[36] \* BD Vacutainer® (16 x 100 mm), (2,5-11 ml)

[36] \* Greiner Vacuette® (16 x 100 mm), (7-9 ml)

[36] \* Sarstedt S-Monovette® (15 x 92 mm), (7,5; 8,2; 8,5 ml)

[36] \* Sarstedt S-Monovette® (16 x 92 mm), (9; 10 ml)

[36] 15046 14 ml probówka z pokrywką (16,8 x 113,7 mm), Sarstedt®  
14 ml tube with cap (16,8 x 113,7 mm), Sarstedt®

[36] 15048 15 ml Thermo Nalgene® (16 x 113 mm)

15 ml Thermo Nalgene® (16 x 113 mm)

[36] 15053 10 ml probówka z pokrywką (16 x 106 mm)

10 ml tube with cap (16 x 106 mm)

[36] 15118 10 ml probówka szklana (16 x 100 mm)

10 ml glass tube (16 x 100 mm)

[36] \* 15 ml probówka z dnem stożkowym z zakrętką (17 x 120 mm), Falcon®; [15050], 15ml (17 x 120 mm)  
15 ml tube, conical bottom, with cap (17 x 120 mm), Falcon®; [15050] 15ml Sarstedt®(17 x 120 mm)**13081****14082**

[36] \* BD Vacutainer® (13 x 75 mm), (1,6-5,3 ml)

[36] \* Greiner Vacuette® (13 x 75 mm), (1-4,5 ml)

[36] \* Sarstedt S-Monovette® (11 x 66 mm), (1,6; 2; 2,7; 3; 3,1 ml)

[36] \* Sarstedt S-Monovette® (13 x 65 mm), (2,6; 2,9; 3,4; 3,8 ml)

[36] \* Sarstedt S-Monovette® (13 x 75 mm), (2,7; 3; 4,3 ml)

[36] 15120 5 ml probówka szklana (12 x 75 mm)

5 ml glass tube (12 x 75 mm)

\* probówka niedostępna w ofercie MPW lub dostępny odpowiednik (np:[15050]), patrz kolumna z prawej  
tube is not offered by MPW or equivalent is available (e.g. [15050]), see column on the right



<b>A. Wyposażenie dodatkowe/Optional accessories</b>	
<b>bez wkładki/without adapter</b>	
[36]	* Sarstedt S-Monovette® (15 x 75 mm), (4; 4,3; 5,5 ml)
[36]	* 10 ml Thermo Nalgene® Oak Ridge (16 x 81,5 mm)
[36]	15121 10 ml probówka z dnem okrągłym i pokrywką (17 x 70 mm) 10 ml tube, round bottom, with cap (17 x 70 mm)
<b>11457</b>	
<b>RPM 10000, RCF 10733, Rmax 96, <math>\alpha</math> 30</b>	
<b>bez pojemnika/without bucket</b>	
<b>14035</b>	
[6]	15046 14 ml probówka z pokrywką (16,8 x 113,7 mm), Sarstedt® 14 ml tube with cap (16,8 x 113,7 mm), Sarstedt®
[6]	15048 15 ml Thermo Nalgene® (16 x 113 mm) 15 ml Thermo Nalgene® (16 x 113 mm)
[6]	15118 10 ml probówka szklana (16 x 100 mm) 10 ml glass tube (16 x 100 mm)
<b>14036</b>	
[6]	15054 6 ml probówka z pokrywką (11,5 x 92 mm), Sarstedt® 6 ml tube with cap (11,5 x 92 mm), Sarstedt®
[6]	15119 7 ml probówka szklana (12 x 100 mm) 7 ml glass tube (12 x 100 mm)
<b>14043</b>	
[6]	* Greiner Vacuette® (13 x 75 mm), (1-4,5 ml)
[6]	15120 5 ml probówka szklana (12 x 75 mm) 5 ml glass tube (12 x 75 mm)
[6]	15419 5 ml probówka z korkiem (12 x 85 mm), Sarstedt® 5 ml tube with cap (12 x 85 mm), Sarstedt®
<b>14071</b>	
[6]	* 28 ml Thermo Nalgene® Oak Ridge (25,4 x 101,8 mm)
[6]	15055 30 ml probówka z pokrywką (25,4 x 103,2 mm) 30 ml tube with cap (25,4 x 103,2 mm)
[6]	15056 30 ml Thermo Nalgene® Oak Ridge (25,5 x 94,3 mm) 30 ml Thermo Nalgene® Oak Ridge (25,5 x 94,3 mm)
[6]	15117 25 ml probówka szklana (25 x 100 mm) 25 ml glass tube (25 x 100 mm)
<b>14073</b>	
[6]	* Greiner Vacuette® (16 x 100 mm), (7-9 ml)
[6]	15046 14 ml probówka z pokrywką (16,8 x 113,7 mm), Sarstedt® 14 ml tube with cap (16,8 x 113,7 mm), Sarstedt®
[6]	15053 10 ml probówka z pokrywką (16 x 106 mm) 10 ml tube with cap (16 x 106 mm)
[6]	15118 10 ml probówka szklana (16 x 100 mm) 10 ml glass tube (16 x 100 mm)
<b>14089</b>	
[6]	* 15 ml probówka z dnem stożkowym z zakrętką (17 x 120 mm), Falcon®; [15050], 15ml (17 x 120 mm) 15 ml tube, conical bottom, with cap (17 x 120 mm), Falcon®; [15050] 15ml Sarstedt® (17 x 120 mm)
<b>14089+14868</b>	
[6]	* 5 ml probówka z korkiem wciskany (17 x 54,2 mm), Eppendorf® 5 ml tube with snap cap (17 x 54,2 mm), Eppendorf®
[6]	* 5 ml probówka z korkiem zakręcany (17 x 66 mm), Eppendorf® 5 ml tube with screw cap (17 x 66 mm), Eppendorf®
<b>bez wkładki/without adapter</b>	
[6]	* 50 ml probówka z dnem stożkowym z zakrętką (30 x 117 mm), Falcon®; [15052] 50ml (30 x 117mm) 50 ml tube, conical bottom, with cap (30 x 117 mm), Falcon®; [15052] 50ml Sarstedt® (30 x 117 mm)
[6]	* 50 ml probówka z dnem stożkowym bez rantu (30 x 115 mm), Greiner® 50 ml tube, conical bottom, without skirt (30 x 115 mm), Greiner®
<b>11458</b>	
<b>RPM 15000, RCF 19621, Rmax 78, <math>\alpha</math> 30</b>	
<b>bez pojemnika/without bucket</b>	
<b>bez wkładki/without adapter</b>	
[6]	15056 30 ml Thermo Nalgene® Oak Ridge (25,5 x 94,3 mm) 30 ml Thermo Nalgene® Oak Ridge (25,5 x 94,3 mm)
[6]	15424 30 ml probówka z pokrywką (25,5 x 94 mm), Nalgene® 30 ml tube with cap (25,5 x 94 mm), Nalgene®

<b>A. Wyposażenie dodatkowe/Optional accessories</b>	
<b>11459</b>	
<b>RPM 15000, RCF 21382, Rmax 85, <math>\phi</math> 30</b>	
bez pojemnika/without bucket	
bez wkładki/without adapter	
[12]	15121 10 ml probówka z dnem okrągłym i pokrywką (17 x 70 mm) 10 ml tube, round bottom, with cap (17 x 70 mm)
<b>11460</b>	
<b>RPM 18000, RCF 29703, Rmax 82, <math>\phi</math> 45</b>	
bez pojemnika/without bucket	
<b>14134</b>	
[36]	15125 0,2 ml probówka PCR (6 x 21,6 mm) 0,2 ml PCR tube (6 x 21,6 mm)
bez wkładki/without adapter	
[36]	15127 0,5 ml probówka PCR (7,8 x 31 mm) 0,5 ml PCR tube (7,8 x 31 mm)
<b>11461</b>	
<b>RPM 16000, RCF 23755, Rmax 83, <math>\phi</math> 45 (352)</b>	
bez pojemnika/without bucket	
<b>14084</b>	
[24]	15127 0,5 ml probówka PCR (7,8 x 31 mm) 0,5 ml PCR tube (7,8 x 31 mm)
<b>14126</b>	
[24]	15124 0,4 ml probówka PCR (5,7 x 48,6 mm) 0,4 ml PCR tube (5,7 x 48,6 mm)
<b>14133</b>	
[24]	15125 0,2 ml probówka PCR (6 x 21,6 mm) 0,2 ml PCR tube (6 x 21,6 mm)
bez wkładki/without adapter	
[24]	* 2-1,5 ml probówka (10,8x41,8 mm), Eppendorf®; [15011], 2 ml (10,8x41,8 mm); [15128], 1,5ml (10,8x40,5 mm) 2-1,5 ml tube (10,8x41,8 mm), Eppendorf®; [15011], 2 ml (10,8x41,8 mm); [15128], 1,5ml (10,8x40,5 mm)
<b>RPM 18000, RCF 30065, Rmax 83, <math>\phi</math> 45 (352R/RH)</b>	
bez pojemnika/without bucket	
<b>14084</b>	
[24]	15127 0,5 ml probówka PCR (7,8 x 31 mm) 0,5 ml PCR tube (7,8 x 31 mm)
<b>14126</b>	
[24]	15124 0,4 ml probówka PCR (5,7 x 48,6 mm) 0,4 ml PCR tube (5,7 x 48,6 mm)
<b>14133</b>	
[24]	15125 0,2 ml probówka PCR (6 x 21,6 mm) 0,2 ml PCR tube (6 x 21,6 mm)
bez wkładki/without adapter	
[24]	* 2-1,5 ml probówka (10,8x41,8 mm), Eppendorf®; [15011], 2 ml (10,8x41,8 mm); [15128], 1,5ml (10,8x40,5 mm) 2-1,5 ml tube (10,8x41,8 mm), Eppendorf®; [15011], 2 ml (10,8x41,8 mm); [15128], 1,5ml (10,8x40,5 mm)

**A. Wyposażenie dodatkowe/Optional accessories****11462****RPM 16000, RCF 23755, Rmax 83,  $\phi$  45 (352)****bez pojemnika/without bucket****14084**[36] 15127 0,5 ml probówka PCR (7,8 x 31 mm)  
0,5 ml PCR tube (7,8 x 31 mm)**14126**[36] 15124 0,4 ml probówka PCR (5,7 x 48,6 mm)  
0,4 ml PCR tube (5,7 x 48,6 mm)**14133**[36] 15125 0,2 ml probówka PCR (6 x 21,6 mm)  
0,2 ml PCR tube (6 x 21,6 mm)**bez wkładki/without adapter**[36] \* 2-1,5 ml probówka (10,8x41,8 mm), Eppendorf®; [15011], 2 ml (10,8x41,8 mm); [15128], 1,5ml (10,8x40,5 mm)  
2-1,5 ml tube (10,8x41,8 mm), Eppendorf®; [15011], 2 ml (10,8x41,8 mm); [15128], 1,5ml (10,8x40,5 mm)**RPM 18000, RCF 30065, Rmax 83,  $\phi$  45 (352R/RH)****bez pojemnika/without bucket****14084**[36] 15127 0,5 ml probówka PCR (7,8 x 31 mm)  
0,5 ml PCR tube (7,8 x 31 mm)**14126**[36] 15124 0,4 ml probówka PCR (5,7 x 48,6 mm)  
0,4 ml PCR tube (5,7 x 48,6 mm)**14133**[36] 15125 0,2 ml probówka PCR (6 x 21,6 mm)  
0,2 ml PCR tube (6 x 21,6 mm)**bez wkładki/without adapter**[36] \* 2-1,5 ml probówka (10,8x41,8 mm), Eppendorf®; [15011], 2 ml (10,8x41,8 mm); [15128], 1,5ml (10,8x40,5 mm)  
2-1,5 ml tube (10,8x41,8 mm), Eppendorf®; [15011], 2 ml (10,8x41,8 mm); [15128], 1,5ml (10,8x40,5 mm)**11465****RPM 5200, RCF 4021, Rmax 133,  $\phi$  30****13080****14082**

[30] \* BD Vacutainer® (13 x 100 mm), (4-7 ml)

[30] \* Greiner Vacuette® (13 x 100 mm), (3,5-6 ml)

[30] \* Sarstedt S-Monovette® (11 x 92 mm), (4,5; 5 ml)

[30] 15054 6 ml probówka z pokrywką (11,5 x 92 mm), Sarstedt®  
6 ml tube with cap (11,5 x 92 mm), Sarstedt®[30] 15119 7 ml probówka szklana (12 x 100 mm)  
7 ml glass tube (12 x 100 mm)**bez wkładki/without adapter**

[30] \* BD Vacutainer® (16 x 100 mm), (2,5-11 ml)

[30] \* Greiner Vacuette® (16 x 100 mm), (7-9 ml)

[30] \* Sarstedt S-Monovette® (15 x 92 mm), (7,5; 8,2; 8,5 ml)

[30] \* Sarstedt S-Monovette® (16 x 92 mm), (9; 10 ml)

[30] 15046 14 ml probówka z pokrywką (16,8 x 113,7 mm), Sarstedt®  
14 ml tube with cap (16,8 x 113,7 mm), Sarstedt®[30] 15048 15 ml Thermo Nalgene® (16 x 113 mm)  
15 ml Thermo Nalgene® (16 x 113 mm)[30] 15053 10 ml probówka z pokrywką (16 x 106 mm)  
10 ml tube with cap (16 x 106 mm)[30] 15118 10 ml probówka szklana (16 x 100 mm)  
10 ml glass tube (16 x 100 mm)[30] \* 15 ml probówka z dnem stożkowym z zakrętką (17 x 120 mm), Falcon®; [15050], 15ml (17 x 120 mm)  
15 ml tube, conical bottom, with cap (17 x 120 mm), Falcon®; [15050] 15ml Sarstedt®(17 x 120 mm)

**A. Wyposażenie dodatkowe/Optional accessories****13081****14082**

- [30] \* BD Vacutainer® (13 x 75 mm), (1,6-5,3 ml)
- [30] \* Greiner Vacuette® (13 x 75 mm), (1-4,5 ml)
- [30] \* Sarstedt S-Monovette® (11 x 66 mm), (1,6; 2; 2,7; 3; 3,1 ml)
- [30] \* Sarstedt S-Monovette® (13 x 65 mm), (2,6; 2,9; 3,4; 3,8 ml)
- [30] \* Sarstedt S-Monovette® (13 x 75 mm), (2,7; 3; 4,3 ml)
- [30] 15120 5 ml probówka szklana (12 x 75 mm)  
5 ml glass tube (12 x 75 mm)

**bez wkładki/without adapter**

- [30] \* Sarstedt S-Monovette® (15 x 75 mm), (4; 4,3; 5,5 ml)
- [30] \* 10 ml Thermo Nalgene® Oak Ridge (16 x 81,5 mm)
- [30] 15121 10 ml probówka z dnem okrągłym i pokrywką (17 x 70 mm)  
10 ml tube, round bottom, with cap (17 x 70 mm)

**11466****RPM 10000, RCF 10733, Rmax 96,  $\phi$  29****bez pojemnika/without bucket****14047**

- [10] 15419 5 ml probówka z korkiem (12 x 85 mm), Sarstedt®  
5 ml tube with cap (12 x 85 mm), Sarstedt®

**14868**

- [10] \* 5 ml probówka z korkiem wciskany (17 x 54,2 mm), Eppendorf®  
5 ml tube with snap cap (17 x 54,2 mm), Eppendorf®
- [10] \* 5 ml probówka z korkiem zakręcany (17 x 66 mm), Eppendorf®  
5 ml tube with screw cap (17 x 66 mm), Eppendorf®

**bez wkładki/without adapter**

- [10] \* 15 ml probówka z dnem stożkowym z zakrętką (17 x 120 mm), Falcon®; [15050], 15ml (17 x 120 mm)  
15 ml tube, conical bottom, with cap (17 x 120 mm), Falcon®; [15050] 15ml Sarstedt®(17 x 120 mm)

**11467****RPM 12000, RCF 15133, Rmax 94,  $\phi$  30****bez pojemnika/without bucket****bez wkładki/without adapter**

- [12] 15046 14 ml probówka z pokrywką (16,8 x 113,7 mm), Sarstedt®  
14 ml tube with cap (16,8 x 113,7 mm), Sarstedt®
- [12] 15048 15 ml Thermo Nalgene® (16 x 113 mm)  
15 ml Thermo Nalgene® (16 x 113 mm)
- [12] 15053 10 ml probówka z pokrywką (16 x 106 mm)  
10 ml tube with cap (16 x 106 mm)

**11468****RPM 12000, RCF 15294, Rmax 95,  $\phi$  45****bez pojemnika/without bucket****bez wkładki/without adapter**

- [6] 15122 8 x 0,2 ml probówki szeregowe PCR-strip (10,2 x 72,4 mm)  
8 x 0,2 ml PCR strip (10,2 x 72,4 mm)
- [48] 15125 0,2 ml probówka PCR (6 x 21,6 mm)  
0,2 ml PCR tube (6 x 21,6 mm)
- [6] 15130 8 x 0,2 ml probówki szeregowe PCR strip (7,3 x 77,2 mm)  
8 x 0,2 ml PCR strip (7,3 x 77,2 mm)
- [6] 15131 4 x 0,2 ml probówki szeregowe PCR-strip (10,2 x 37,2 mm)  
4 x 0,2 ml PCR strip (10,2 x 37,2 mm)

**A. Wyposażenie dodatkowe/Optional accessories****11469****RPM 12000, RCF 14489, Rmax 90,  $\pm$  30****bez pojemnika/without bucket****14035**[6] 15046 14 ml probówka z pokrywką (16,8 x 113,7 mm), Sarstedt®  
14 ml tube with cap (16,8 x 113,7 mm), Sarstedt®[6] 15053 10 ml probówka z pokrywką (16 x 106 mm)  
10 ml tube with cap (16 x 106 mm)**14036**[6] 15054 6 ml probówka z pokrywką (11,5 x 92 mm), Sarstedt®  
6 ml tube with cap (11,5 x 92 mm), Sarstedt®**bez wkładki/without adapter**[6] 15051 50 ml Thermo Nalgene® Oak Ridge (28,8 x 106,7 mm)  
50 ml Thermo Nalgene® Oak Ridge (28,8 x 106,7 mm)**11496****RPM 10000, RCF 10621, Rmax 95,  $\pm$  30****bez pojemnika/without bucket****bez wkładki/without adapter**[4] 15056 30 ml Thermo Nalgene® Oak Ridge (25,5 x 94,3 mm)  
30 ml Thermo Nalgene® Oak Ridge (25,5 x 94,3 mm)[4] 15067 85 ml Thermo Nalgene® Oak Ridge (38,2 x 105,7 mm)  
85 ml Thermo Nalgene® Oak Ridge (38,2 x 105,7 mm)**11501****RPM 5200, RCF 4021, Rmax 133,  $\pm$  30****13080****14082**

[30] \* BD Vacutainer® (13 x 100 mm), (4-7 ml)

[30] \* Greiner Vacuette® (13 x 100 mm), (3,5-6 ml)

[30] \* Sarstedt S-Monovette® (11 x 92 mm), (4,5; 5 ml)

[30] 15054 6 ml probówka z pokrywką (11,5 x 92 mm), Sarstedt®  
6 ml tube with cap (11,5 x 92 mm), Sarstedt®[30] 15119 7 ml probówka szklana (12 x 100 mm)  
7 ml glass tube (12 x 100 mm)**bez wkładki/without adapter**

[30] \* BD Vacutainer® (16 x 100 mm), (2,5-11 ml)

[30] \* Greiner Vacuette® (16 x 100 mm), (7-9 ml)

[30] \* Sarstedt S-Monovette® (15 x 92 mm), (7,5; 8,2; 8,5 ml)

[30] \* Sarstedt S-Monovette® (16 x 92 mm), (9; 10 ml)

[30] 15119 7 ml probówka szklana (12 x 100 mm)  
7 ml glass tube (12 x 100 mm)[30] 15046 14 ml probówka z pokrywką (16,8 x 113,7 mm), Sarstedt®  
14 ml tube with cap (16,8 x 113,7 mm), Sarstedt®[30] 15048 15 ml Thermo Nalgene® (16 x 113 mm)  
15 ml Thermo Nalgene® (16 x 113 mm)[30] 15053 10 ml probówka z pokrywką (16 x 106 mm)  
10 ml tube with cap (16 x 106 mm)[30] 15118 10 ml probówka szklana (16 x 100 mm)  
10 ml glass tube (16 x 100 mm)[30] \* 15 ml probówka z dnem stożkowym z zakrętką (17 x 120 mm), Falcon®; [15050], 15ml (17 x 120 mm)  
15 ml tube, conical bottom, with cap (17 x 120 mm), Falcon®; [15050] 15ml Sarstedt®(17 x 120 mm)

<b>A. Wyposażenie dodatkowe/Optional accessories</b>	
<b>13081</b>	
<b>14082</b>	
[30]	* BD Vacutainer® (13 x 75 mm), (1,6-5,3 ml)
[30]	* Greiner Vacuette® (13 x 75 mm), (1-4,5 ml)
[30]	* Sarstedt S-Monovette® (11 x 66 mm), (1,6; 2; 2,7; 3; 3,1 ml)
[30]	* Sarstedt S-Monovette® (13 x 65 mm), (2,6; 2,9; 3,4; 3,8 ml)
[30]	* Sarstedt S-Monovette® (13 x 75 mm), (2,7; 3; 4,3 ml)
[30]	15120 5 ml probówka szklana (12 x 75 mm)
	5 ml glass tube (12 x 75 mm)
<b>bez wkładki/without adapter</b>	
[30]	* Sarstedt S-Monovette® (15 x 75 mm), (4; 4,3; 5,5 ml)
[30]	* 10 ml Thermo Nalgene® Oak Ridge (16 x 81,5 mm)
[30]	15121 10 ml probówka z dnem okrągłym i pokrywką (17 x 70 mm)
	10 ml tube, round bottom, with cap (17 x 70 mm)
<b>11503</b>	
<b>RPM 2000, RCF 733, Rmax 164, <math>\phi</math> 40</b>	
<b>13504</b>	
<b>14505</b>	
[8]	* butelka Babcocka (36,2 x 170 mm)
	Babcock bottle (36,2 x 170 mm)
<b>11585</b>	
<b>RPM 14000, RCF 20817, Rmax 95, <math>\phi</math> 45</b>	
<b>bez pojemnika/without bucket</b>	
<b>bez wkładki/without adapter</b>	
[12]	15122 8 x 0,2 ml probówki szeregowe PCR-strip (10,2 x 72,4 mm)
	8 x 0,2 ml PCR strip (10,2 x 72,4 mm)
[96]	15125 0,2 ml probówka PCR (6 x 21,6 mm)
	0,2 ml PCR tube (6 x 21,6 mm)
[12]	15130 8 x 0,2 ml probówki szeregowe PCR strip (7,3 x 77,2 mm)
	8 x 0,2 ml PCR strip (7,3 x 77,2 mm)
[12]	15131 4 x 0,2 ml probówki szeregowe PCR-strip (10,2 x 37,2 mm)
	4 x 0,2 ml PCR strip (10,2 x 37,2 mm)
<b>11586</b>	
<b>RPM 7000, RCF 6081, Rmax 111, <math>\phi</math> 35</b>	
<b>13587</b>	
<b>14855</b>	
[6]	* 50 ml probówka z dnem stożkowym z zakrętką (30 x 117 mm), Falcon®; [15052] 50ml (30 x 117mm)
	50 ml tube, conical bottom, with cap (30 x 117 mm), Falcon®; [15052] 50ml Sarstedt® (30 x 117 mm)
[6]	* 50 ml probówka z dnem stożkowym bez rantu (30 x 115 mm), Greiner®
	50 ml tube, conical bottom, without skirt (30 x 115 mm), Greiner®
<b>14856</b>	
[6]	* 15 ml probówka z dnem stożkowym z zakrętką (17 x 120 mm), Falcon®; [15050], 15ml (17 x 120 mm)
	15 ml tube, conical bottom, with cap (17 x 120 mm), Falcon®; [15050] 15ml Sarstedt®(17 x 120 mm)
<b>bez wkładki/without adapter</b>	
[6]	15067 85 ml Thermo Nalgene® Oak Ridge (38,2 x 105,7 mm)
	85 ml Thermo Nalgene® Oak Ridge (38,2 x 105,7 mm)

**A. Wyposażenie dodatkowe/Optional accessories****11718****RPM 6300, RCF 5014, Rmax 113,  $\phi$  30****13719****14024**

[4] \* 15 ml probówka z dnem stożkowym z zakrętką (17 x 120 mm), Falcon®; [15050], 15ml (17 x 120 mm)  
15 ml tube, conical bottom, with cap (17 x 120 mm), Falcon®; [15050] 15ml Sarstedt®(17 x 120 mm)

**14188**

[4] 15115 100 ml probówka szklana (44 x 100 mm)  
100 ml glass tube (44 x 100 mm)

**14196**

[4] 15040 100 ml probówka z pokrywką (45,2 x 103,7 mm)  
100 ml tube with cap (45,2 x 103,7 mm)

**14224**

[4] 15056 30 ml Thermo Nalgene® Oak Ridge (25,5 x 94,3 mm)  
30 ml Thermo Nalgene® Oak Ridge (25,5 x 94,3 mm)

[4] 15055 30 ml probówka z pokrywką (25,4 x 103,2 mm)  
30 ml tube with cap (25,4 x 103,2 mm)

[4] 15222 30 ml probówka z pokrywką (25 x 94mm), Sterilin®  
30 ml tube with cap (25 x 94 mm), Sterilin®

[4] 15223 30 ml probówka z pokrywką (25 x 94 mm), Sterilin®  
30 ml tube with cap (25 x 94 mm), Sterilin®

**14226**

[4] \* 50 ml probówka z dnem stożkowym z rantem (30 x 115 mm), Greiner®  
50 ml tube, conical bottom, skirted (30 x 115 mm), Greiner®

**14189C**

[4] 15051 50 ml Thermo Nalgene® Oak Ridge (28,8 x 106,7 mm)  
50 ml Thermo Nalgene® Oak Ridge (28,8 x 106,7 mm)

[4] \* 50 ml probówka z dnem stożkowym z zakrętką (30 x 117 mm), Falcon®; [15052] 50ml (30 x 117mm)  
50 ml tube, conical bottom, with cap (30 x 117 mm), Falcon®; [15052] 50ml Sarstedt® (30 x 117 mm)

[4] \* 50 ml probówka z dnem stożkowym bez rantu (30 x 115 mm), Greiner®  
50 ml tube, conical bottom, without skirt (30 x 115 mm), Greiner®

[4] \* 50 ml probówka Advanced Oak Ridge (29x102 mm), Herolab® nr 25 32 11  
50 ml tube, Advanced Oak Ridge (29 x 102 mm), Herolab® no. 25 32 11

**14190C**

[4] 15055 30 ml probówka z pokrywką (25,4 x 103,2 mm)  
30 ml tube with cap (25,4 x 103,2 mm)

[4] 15117 25 ml probówka szklana (25 x 100 mm)  
25 ml glass tube (25 x 100 mm)

**14192C**

[4] 15116 50 ml probówka szklana (35 x 100 mm)  
50 ml glass tube (35 x 100 mm)

**11740****RPM 5500, RCF 4058, Rmax 120,  $\phi$  30****13080****14082**

[12] \* BD Vacutainer® (13 x 100 mm), (4-7 ml)

[12] \* Greiner Vacuette® (13 x 100 mm), (3,5-6 ml)

[12] \* Sarstedt S-Monovette® (11 x 92 mm), (4,5; 5 ml)

[12] 15054 6 ml probówka z pokrywką (11,5 x 92 mm), Sarstedt®  
6 ml tube with cap (11,5 x 92 mm), Sarstedt®

[12] 15119 7 ml probówka szklana (12 x 100 mm)  
7 ml glass tube (12 x 100 mm)

<b>A. Wyposażenie dodatkowe/Optional accessories</b>		
<b>bez wkładki/without adapter</b>		
[12]	*	BD Vacutainer® (16 x 100 mm), (2,5-11 ml)
[12]	*	Greiner Vacuette® (16 x 100 mm), (7-9 ml)
[12]	*	Sarstedt S-Monovette® (15 x 92 mm), (7,5; 8,2; 8,5 ml)
[12]	*	Sarstedt S-Monovette® (16 x 92 mm), (9; 10 ml)
[12]	15046	14 ml probówka z pokrywką (16,8 x 113,7 mm), Sarstedt® 14 ml tube with cap (16,8 x 113,7 mm), Sarstedt®
[12]	15048	15 ml Thermo Nalgene® (16 x 113 mm) 15 ml Thermo Nalgene® (16 x 113 mm)
[12]	15053	10 ml probówka z pokrywką (16 x 106 mm) 10 ml tube with cap (16 x 106 mm)
[12]	15118	10 ml probówka szklana (16 x 100 mm) 10 ml glass tube (16 x 100 mm)
[12]	*	15 ml probówka z dnem stożkowym z zakrętką (17 x 120 mm), Falcon®; [15050], 15ml (17 x 120 mm) 15 ml tube, conical bottom, with cap (17 x 120 mm), Falcon®; [15050] 15ml Sarstedt®(17 x 120 mm)
<b>13081</b>		
<b>14082</b>		
[12]	*	BD Vacutainer® (13 x 75 mm), (1,6-5,3 ml)
[12]	*	Greiner Vacuette® (13 x 75 mm), (1-4,5 ml)
[12]	*	Sarstedt S-Monovette® (11 x 66 mm), (1,6; 2; 2,7; 3; 3,1 ml)
[12]	*	Sarstedt S-Monovette® (13 x 65 mm), (2,6; 2,9; 3,4; 3,8 ml)
[12]	*	Sarstedt S-Monovette® (13 x 75 mm), (2,7; 3; 4,3 ml)
[12]	15419	5 ml probówka z korkiem (12 x 85 mm), Sarstedt® 5 ml tube with cap (12 x 85 mm), Sarstedt®
[12]	15120	5 ml probówka szklana (12 x 75 mm) 5 ml glass tube (12 x 75 mm)
<b>bez wkładki/without adapter</b>		
[12]	*	Sarstedt S-Monovette® (15 x 75 mm), (4; 4,3; 5,5 ml)
[12]	*	10 ml Thermo Nalgene® Oak Ridge (16 x 81,5 mm)
[12]	15121	10 ml probówka z dnem okrągłym i pokrywką (17 x 70 mm) 10 ml tube, round bottom, with cap (17 x 70 mm)
<b>11741</b>		
<b>RPM 6000, RCF 4226, Rmax 105, ɳ 30</b>		
<b>13080</b>		
<b>14082</b>		
[8]	*	BD Vacutainer® (13 x 100 mm), (4-7 ml)
[8]	*	Greiner Vacuette® (13 x 100 mm), (3,5-6 ml)
[8]	*	Sarstedt S-Monovette® (11 x 92 mm), (4,5; 5 ml)
[8]	15054	6 ml probówka z pokrywką (11,5 x 92 mm), Sarstedt® 6 ml tube with cap (11,5 x 92 mm), Sarstedt®
[8]	15119	7 ml probówka szklana (12 x 100 mm) 7 ml glass tube (12 x 100 mm)
<b>bez wkładki/without adapter</b>		
[8]	*	BD Vacutainer® (16 x 100 mm), (2,5-11 ml)
[8]	*	Greiner Vacuette® (16 x 100 mm), (7-9 ml)
[8]	*	Sarstedt S-Monovette® (15 x 92 mm), (7,5; 8,2; 8,5 ml)
[8]	*	Sarstedt S-Monovette® (16 x 92 mm), (9; 10 ml)
[8]	15046	14 ml probówka z pokrywką (16,8 x 113,7 mm), Sarstedt® 14 ml tube with cap (16,8 x 113,7 mm), Sarstedt®
[8]	15048	15 ml Thermo Nalgene® (16 x 113 mm) 15 ml Thermo Nalgene® (16 x 113 mm)
[8]	15053	10 ml probówka z pokrywką (16 x 106 mm) 10 ml tube with cap (16 x 106 mm)
[8]	15118	10 ml probówka szklana (16 x 100 mm) 10 ml glass tube (16 x 100 mm)
[8]	*	15 ml probówka z dnem stożkowym z zakrętką (17 x 120 mm), Falcon®; [15050], 15ml (17 x 120 mm) 15 ml tube, conical bottom, with cap (17 x 120 mm), Falcon®; [15050] 15ml Sarstedt®(17 x 120 mm)



**A. Wyposażenie dodatkowe/Optional accessories****13081****14082**

[8]	*	BD Vacutainer® (13 x 75 mm), (1,6-5,3 ml)
[8]	*	Greiner Vacuette® (13 x 75 mm), (1-4,5 ml)
[8]	*	Sarstedt S-Monovette® (11 x 66 mm), (1,6; 2; 2,7; 3; 3,1 ml)
[8]	*	Sarstedt S-Monovette® (13 x 65 mm), (2,6; 2,9; 3,4; 3,8 ml)
[8]	*	Sarstedt S-Monovette® (13 x 75 mm), (2,7; 3; 4,3 ml)
[8]	15120	5 ml probówka szklana (12 x 75 mm) 5 ml glass tube (12 x 75 mm)
[8]	15419	5 ml probówka z korkiem (12 x 85 mm), Sarstedt® 5 ml tube with cap (12 x 85 mm), Sarstedt®
<b>bez wkładki/without adapter</b>		
[8]	*	Sarstedt S-Monovette® (15 x 75 mm), (4; 4,3; 5,5 ml)
[8]	*	10 ml Thermo Nalgene® Oak Ridge (16 x 81,5 mm)
[8]	15121	10 ml probówka z dnem okrągłym i pokrywką (17 x 70 mm) 10 ml tube, round bottom, with cap (17 x 70 mm)

**11743****RPM 5500, RCF 4058, Rmax 120,  $\phi$  30****13329****14255**

[12]	*	Sarstedt S-Monovette® (11 x 92 mm), (4,5; 5 ml)
[12]	15119	7 ml probówka szklana (12 x 100 mm) 7 ml glass tube (12 x 100 mm)

**14256**

[12]	15046	14 ml probówka z pokrywką (16,8 x 113,7 mm), Sarstedt® 14 ml tube with cap (16,8 x 113,7 mm), Sarstedt®
[12]	15048	15 ml Thermo Nalgene® (16 x 113 mm) 15 ml Thermo Nalgene® (16 x 113 mm)
[12]	15053	10 ml probówka z pokrywką (16 x 106 mm) 10 ml tube with cap (16 x 106 mm)
[12]	15118	10 ml probówka szklana (16 x 100 mm) 10 ml glass tube (16 x 100 mm)
<b>bez wkładki/without adapter</b>		
[12]	15055	30 ml probówka z pokrywką (25,4 x 103,2 mm) 30 ml tube with cap (25,4 x 103,2 mm)
[12]	15424	30 ml probówka z pokrywką (25,5 x 94 mm), Nalgene® 30 ml tube with cap (25,5 x 94 mm), Nalgene®
[12]	15222	30 ml probówka z pokrywką (25 x 94mm), Sterilin® 30 ml tube with cap (25 x 94 mm), Sterilin®
[12]	15223	30 ml probówka z pokrywką (25 x 94 mm), Sterilin® 30 ml tube with cap (25 x 94 mm), Sterilin®

**11746****RPM 6000, RCF 4427, Rmax 110,  $\phi$  30****13276****14035**

[6]	15046	14 ml probówka z pokrywką (16,8 x 113,7 mm), Sarstedt® 14 ml tube with cap (16,8 x 113,7 mm), Sarstedt®
[6]	15048	15 ml Thermo Nalgene® (16 x 113 mm) 15 ml Thermo Nalgene® (16 x 113 mm)
[6]	15053	10 ml probówka z pokrywką (16 x 106 mm) 10 ml tube with cap (16 x 106 mm)
[6]	15118	10 ml probówka szklana (16 x 100 mm) 10 ml glass tube (16 x 100 mm)

**14036**

[6]	*	BD Vacutainer® (13 x 100 mm), (4-7 ml)
[6]	*	Greiner Vacuette® (13 x 100 mm), (3,5-6 ml)
[6]	15054	6 ml probówka z pokrywką (11,5 x 92 mm), Sarstedt® 6 ml tube with cap (11,5 x 92 mm), Sarstedt®
[6]	15119	7 ml probówka szklana (12 x 100 mm) 7 ml glass tube (12 x 100 mm)

<b>A. Wyposażenie dodatkowe/Optional accessories</b>	
<b>14043</b>	
[6]	* Greiner Vacuette® (13 x 75 mm), (1-4,5 ml)
[6]	* Sarstedt S-Monovette® (13 x 75 mm), (2,7; 3; 4,3 ml)
[6]	* Sarstedt S-Monovette® (13 x 90 mm), (4,9; 5,6 ml)
[6]	15120 5 ml probówka szklana (12 x 75 mm) 5 ml glass tube (12 x 75 mm)
[6]	15419 5 ml probówka z korkiem (12 x 85 mm), Sarstedt® 5 ml tube with cap (12 x 85 mm), Sarstedt®
<b>14071</b>	
[6]	* 28 ml Thermo Nalgene® Oak Ridge (25,4 x 101,8 mm)
[6]	15055 30 ml probówka z pokrywką (25,4 x 103,2 mm) 30 ml tube with cap (25,4 x 103,2 mm)
[6]	15056 30 ml Thermo Nalgene® Oak Ridge (25,5 x 94,3 mm) 30 ml Thermo Nalgene® Oak Ridge (25,5 x 94,3 mm)
[6]	15117 25 ml probówka szklana (25 x 100 mm) 25 ml glass tube (25 x 100 mm)
[6]	15424 30 ml probówka z pokrywką (25,5 x 94 mm), Nalgene® 30 ml tube with cap (25,5 x 94 mm), Nalgene®
<b>14073</b>	
[6]	* BD Vacutainer® (16 x 100 mm), (2,5-11 ml)
[6]	* Greiner Vacuette® (16 x 100 mm), (7-9 ml)
[6]	* Sarstedt S-Monovette® (15 x 92 mm), (7,5; 8,2; 8,5 ml)
[6]	* Sarstedt S-Monovette® (16 x 92 mm), (9; 10 ml)
[6]	15046 14 ml probówka z pokrywką (16,8 x 113,7 mm), Sarstedt® 14 ml tube with cap (16,8 x 113,7 mm), Sarstedt®
[6]	15053 10 ml probówka z pokrywką (16 x 106 mm) 10 ml tube with cap (16 x 106 mm)
[6]	15118 10 ml probówka szklana (16 x 100 mm) 10 ml glass tube (16 x 100 mm)
<b>14089</b>	
[6]	* 15 ml probówka z dnem stożkowym z zakrętką (17 x 120 mm), Falcon®; [15050], 15ml (17 x 120 mm) 15 ml tube, conical bottom, with cap (17 x 120 mm), Falcon®; [15050] 15ml Sarstedt®(17 x 120 mm)
<b>14248</b>	
[6]	15055 30 ml probówka z pokrywką (25,4 x 103,2 mm) 30 ml tube with cap (25,4 x 103,2 mm)
[6]	15117 25 ml probówka szklana (25 x 100 mm) 25 ml glass tube (25 x 100 mm)
<b>14089+14868</b>	
[6]	* 5 ml probówka z korkiem wciskany (17 x 54,2 mm), Eppendorf® 5 ml tube with snap cap (17 x 54,2 mm), Eppendorf®
[6]	* 5 ml probówka z korkiem zakręcany (17 x 66 mm), Eppendorf® 5 ml tube with screw cap (17 x 66 mm), Eppendorf®
<b>bez wkładki/without adapter</b>	
[6]	* 50 ml probówka z dnem stożkowym z zakrętką (30 x 117 mm), Falcon®; [15052] 50ml (30 x 117mm) 50 ml tube, conical bottom, with cap (30 x 117 mm), Falcon®; [15052] 50ml Sarstedt® (30 x 117 mm)
[6]	* 50 ml probówka z dnem stożkowym bez rantu (30 x 115 mm), Greiner® 50 ml tube, conical bottom, without skirt (30 x 115 mm), Greiner®
[6]	15051 50 ml Thermo Nalgene® Oak Ridge (28,8 x 106,7 mm) 50 ml Thermo Nalgene® Oak Ridge (28,8 x 106,7 mm)
[6]	* 50 ml probówka Advanced Oak Ridge (29x102 mm), Herolab® nr 25 32 11 50 ml tube, Advanced Oak Ridge (29 x 102 mm), Herolab® no. 25 32 11
<b>11760</b>	
<b>RPM 13000, RCF 16060, Rmax 85, 45 (352)</b>	
<b>bez pojemnika/without bucket</b>	
<b>14084</b>	
[24]	15127 0,5 ml probówka PCR (7,8 x 31 mm) 0,5 ml PCR tube (7,8 x 31 mm)
<b>14126</b>	
[24]	15124 0,4 ml probówka PCR (5,7 x 48,6 mm) 0,4 ml PCR tube (5,7 x 48,6 mm)
<b>14133</b>	
[24]	15125 0,2 ml probówka PCR (6 x 21,6 mm) 0,2 ml PCR tube (6 x 21,6 mm)
<b>bez wkładki/without adapter</b>	
[24]	* 2-1,5 ml probówka (10,8x41,8 mm), Eppendorf®; [15011], 2 ml (10,8x41,8 mm); [15128], 1,5ml (10,8x40,5 mm) 2-1,5 ml tube (10,8x41,8 mm), Eppendorf®; [15011], 2 ml (10,8x41,8 mm); [15128], 1,5ml (10,8x40,5 mm)
[24]	* 2 ml probówki z filtrem - spin columns (10,8 x 46 mm) 2 ml spin columns (with filter) (10,8 x 46 mm); [15011], 2 ml (10,8x41,8 mm); [15128], 1,5ml (10,8x40,5 mm)

**A. Wyposażenie dodatkowe/Optional accessories****RPM 15000, RCF 21382, Rmax 85,  $\alpha$  45****bez pojemnika/without bucket****14084**[24] 15127 0,5 ml probówka PCR (7,8 x 31 mm)  
0,5 ml PCR tube (7,8 x 31 mm)**14126**[24] 15124 0,4 ml probówka PCR (5,7 x 48,6 mm)  
0,4 ml PCR tube (5,7 x 48,6 mm)**14133**[24] 15125 0,2 ml probówka PCR (6 x 21,6 mm)  
0,2 ml PCR tube (6 x 21,6 mm)**bez wkładki/without adapter**[24] \* 2-1,5 ml probówka (10,8x41,8 mm), Eppendorf®; [15011], 2 ml (10,8x41,8 mm); [15128], 1,5ml (10,8x40,5 mm)  
2-1,5 ml tube (10,8x41,8 mm), Eppendorf®; [15011], 2 ml (10,8x41,8 mm); [15128], 1,5ml (10,8x40,5 mm)[24] \* 2 ml probówki z filtrem - spin columns (10,8 x 46 mm)  
2 ml spin columns (with filter) (10,8 x 46 mm); [15011], 2 ml (10,8x41,8 mm); [15128], 1,5ml (10,8x40,5 mm)**11944****RPM 15000, RCF 21382, Rmax 85,  $\alpha$  45****bez pojemnika/without bucket****bez wkładki/without adapter**[12] \* 5 ml probówka z korkiem wciskany (17 x 54,2 mm), Eppendorf®  
5 ml tube with snap cap (17 x 54,2 mm), Eppendorf®**12177****RPM 5000, RCF 4724, Rmax 169,  $\alpha$  90****13174****14017**[4] 15129 250 ml butelka okrągłodenna (62 x 122 mm), Herolab® nr 25 34 43  
250 ml round-bottom bottle (62 x 122 mm), Herolab® no. 25 34 43**14120**[8] 15222 30 ml probówka z pokrywką (25 x 94mm), Sterilin®  
30 ml tube with cap (25 x 94 mm), Sterilin®[8] 15223 30 ml probówka z pokrywką (25 x 94 mm), Sterilin®  
30 ml tube with cap (25 x 94 mm), Sterilin®**14151**[4] 15115 100 ml probówka szklana (44 x 100 mm)  
100 ml glass tube (44 x 100 mm)**14152**[4] \* 50 ml probówka z dnem stożkowym z zakrętką (30 x 117 mm), Falcon®; [15052] 50ml (30 x 117mm)  
50 ml tube, conical bottom, with cap (30 x 117 mm), Falcon®; [15052] 50ml Sarstedt® (30 x 117 mm)[4] \* 50 ml probówka z dnem stożkowym bez rantu (30 x 115 mm), Greiner®  
50 ml tube, conical bottom, without skirt (30 x 115 mm), Greiner®**14153**[20] \* 15 ml probówka z dnem stożkowym z zakrętką (17 x 120 mm), Falcon®; [15050], 15ml (17 x 120 mm)  
15 ml tube, conical bottom, with cap (17 x 120 mm), Falcon®; [15050] 15ml Sarstedt®(17 x 120 mm)**14154**

[36] \* BD Vacutainer® (13 x 100 mm), (4-7 ml)

[36] \* Greiner Vacuette® (13 x 100 mm), (3,5-6 ml)

[36] \* Sarstedt S-Monovette® (11 x 92 mm), (4,5; 5 ml)

[36] \* BD Vacutainer® (13 x 75 mm), (1,6-5,3 ml)

[36] \* Greiner Vacuette® (13 x 75 mm), (1-4,5 ml)

[36] \* Sarstedt S-Monovette® (11 x 66 mm), (1,6; 2; 2,7; 3; 3,1 ml)

[36] \* Sarstedt S-Monovette® (13 x 65 mm), (2,6; 2,9; 3,4; 3,8 ml)

[36] \* Sarstedt S-Monovette® (13 x 75 mm), (2,7; 3; 4,3 ml)

[36] \* Sarstedt S-Monovette® (13 x 90 mm), (4,9; 5,6 ml)

[36] 15054 6 ml probówka z pokrywką (11,5 x 92 mm), Sarstedt®  
6 ml tube with cap (11,5 x 92 mm), Sarstedt®[36] 15120 5 ml probówka szklana (12 x 75 mm)  
5 ml glass tube (12 x 75 mm)[36] 15419 5 ml probówka z korkiem (12 x 85 mm), Sarstedt®  
5 ml tube with cap (12 x 85 mm), Sarstedt®\* probówka niedostępna w ofercie MPW lub dostępny odpowiednik (np:[15050]), patrz kolumna z prawej  
tube is not offered by MPW or equivalent is available (e.g. [15050]), see column on the right

<b>A. Wyposażenie dodatkowe/Optional accessories</b>		
<b>14155</b>		
[48]	*	Sarstedt S-Monovette® (11 x 92 mm), (4,5; 5 ml)
[48]	*	Sarstedt S-Monovette® (11 x 66 mm), (1,6; 2; 2,7; 3; 3,1 ml)
[48]	15054	6 ml probówka z pokrywką (11,5 x 92 mm), Sarstedt® 6 ml tube with cap (11,5 x 92 mm), Sarstedt®
[48]	15119	7 ml probówka szklana (12 x 100 mm) 7 ml glass tube (12 x 100 mm)
[48]	15120	5 ml probówka szklana (12 x 75 mm) 5 ml glass tube (12 x 75 mm)
[48]	15419	5 ml probówka z korkiem (12 x 85 mm), Sarstedt® 5 ml tube with cap (12 x 85 mm), Sarstedt®
<b>14156</b>		
[32]	*	BD Vacutainer® (16 x 100 mm), (2,5-11 ml)
[32]	*	Greiner Vacuette® (16 x 100 mm), (7-9 ml)
[32]	*	10 ml Thermo Nalgene® Oak Ridge (16 x 81,5 mm)
[32]	15046	14 ml probówka z pokrywką (16,8 x 113,7 mm), Sarstedt® 14 ml tube with cap (16,8 x 113,7 mm), Sarstedt®
[32]	15053	10 ml probówka z pokrywką (16 x 106 mm) 10 ml tube with cap (16 x 106 mm)
[32]	15118	10 ml probówka szklana (16 x 100 mm) 10 ml glass tube (16 x 100 mm)
<b>14157</b>		
[16]	*	BD Vacutainer® (16 x 100 mm), (2,5-11 ml)
[16]	*	Greiner Vacuette® (16 x 100 mm), (7-9 ml)
[16]	*	Sarstedt S-Monovette® (15 x 92 mm), (7,5; 8,2; 8,5 ml)
[16]	*	Sarstedt S-Monovette® (16 x 92 mm), (9; 10 ml)
[16]	15048	15 ml Thermo Nalgene® (16 x 113 mm) 15 ml Thermo Nalgene® (16 x 113 mm)
[16]	15053	10 ml probówka z pokrywką (16 x 106 mm) 10 ml tube with cap (16 x 106 mm)
[16]	15118	10 ml probówka szklana (16 x 100 mm) 10 ml glass tube (16 x 100 mm)
[16]	*	13 ml probówka (ø16x100mm), Sarstedt® nr 62.515.006 13 ml tube (ø16 x 100 mm), Sarstedt® no. 62.515.006
<b>14158</b>		
[28]	*	2-1,5 ml probówka (10,8x41,8 mm), Eppendorf®; [15011], 2 ml (10,8x41,8 mm); [15128], 1,5ml (10,8x40,5 mm) 2-1,5 ml tube (10,8x41,8 mm), Eppendorf®; [15011], 2 ml (10,8x41,8 mm); [15128], 1,5ml (10,8x40,5 mm)
<b>14160</b>		
[12]	15055	30 ml probówka z pokrywką (25,4 x 103,2 mm) 30 ml tube with cap (25,4 x 103,2 mm)
[12]	15117	25 ml probówka szklana (25 x 100 mm) 25 ml glass tube (25 x 100 mm)
<b>14175</b>		
[4]	15175	250 ml butelka płaskodenna (62 x 122 mm), Herolab® nr 25 34 21 250 ml bottle, flat bottom (62 x 122 mm), Herolab® no. 25 34 21
[4]	15176	250 ml butelka płaskodenna (62 x 122 mm), Herolab® nr 25 34 01 250 ml bottle, flat bottom (62 x 122 mm), Herolab® no. 25 34 01
<b>14151+14159</b>		
[4]	15116	50 ml probówka szklana (35 x 100 mm) 50 ml glass tube (35 x 100 mm)
<b>13180</b>		
<b>14043</b>		
[4]	*	Greiner Vacuette® (13 x 75 mm), (1-4,5 ml)
[4]	15120	5 ml probówka szklana (12 x 75 mm) 5 ml glass tube (12 x 75 mm)
[4]	15419	5 ml probówka z korkiem (12 x 85 mm), Sarstedt® 5 ml tube with cap (12 x 85 mm), Sarstedt®
<b>14089</b>		
[4]	*	15 ml probówka z dnem stożkowym z zakrętką (17 x 120 mm), Falcon®; [15050], 15ml (17 x 120 mm) 15 ml tube, conical bottom, with cap (17 x 120 mm), Falcon®; [15050] 15ml Sarstedt®(17 x 120 mm)
<b>14089+14868</b>		
[4]	*	5 ml probówka z korkiem wciskany (17 x 54,2 mm), Eppendorf® 5 ml tube with snap cap (17 x 54,2 mm), Eppendorf®
[4]	*	5 ml probówka z korkiem zakręcany (17 x 66 mm), Eppendorf® 5 ml tube with screw cap (17 x 66 mm), Eppendorf®
<b>bez wkładki/without adapter</b>		
[4]	*	50 ml probówka z dnem stożkowym z zakrętką (30 x 117 mm), Falcon®; [15052] 50ml (30 x 117mm) 50 ml tube, conical bottom, with cap (30 x 117 mm), Falcon®; [15052] 50ml Sarstedt® (30 x 117 mm)
[4]	*	50 ml probówka z dnem stożkowym bez rantu (30 x 115 mm), Greiner® 50 ml tube, conical bottom, without skirt (30 x 115 mm), Greiner®

**A. Wyposażenie dodatkowe/Optional accessories****13178C****14017**

- [4] 15129 250 ml butelka okrągłodenna (62 x 122 mm), Herolab® nr 25 34 43  
250 ml round-bottom bottle (62 x 122 mm), Herolab® no. 25 34 43

**14151**

- [4] 15115 100 ml probówka szklana (44 x 100 mm)  
100 ml glass tube (44 x 100 mm)

**14152**

- [4] \* 50 ml probówka z dnem stożkowym z zakrętką (30 x 117 mm), Falcon®; [15052] 50ml (30 x 117mm)  
50 ml tube, conical bottom, with cap (30 x 117 mm), Falcon®; [15052] 50ml Sarstedt® (30 x 117 mm)
- [4] \* 50 ml probówka z dnem stożkowym bez rantu (30 x 115 mm), Greiner®  
50 ml tube, conical bottom, without skirt (30 x 115 mm), Greiner®

**14153**

- [20] \* 15 ml probówka z dnem stożkowym z zakrętką (17 x 120 mm), Falcon®; [15050], 15ml (17 x 120 mm)  
15 ml tube, conical bottom, with cap (17 x 120 mm), Falcon®; [15050] 15ml Sarstedt®(17 x 120 mm)

**14154**

- [36] \* BD Vacutainer® (13 x 100 mm), (4-7 ml)
- [36] \* Greiner Vacuette® (13 x 100 mm), (3,5-6 ml)
- [36] \* Sarstedt S-Monovette® (11 x 92 mm), (4,5; 5 ml)
- [36] \* BD Vacutainer® (13 x 75 mm), (1,6-5,3 ml)
- [36] \* Greiner Vacuette® (13 x 75 mm), (1-4,5 ml)
- [36] \* Sarstedt S-Monovette® (11 x 66 mm), (1,6; 2; 2,7; 3; 3,1 ml)
- [36] \* Sarstedt S-Monovette® (13 x 65 mm), (2,6; 2,9; 3,4; 3,8 ml)
- [36] \* Sarstedt S-Monovette® (13 x 75 mm), (2,7; 3; 4,3 ml)
- [36] \* Sarstedt S-Monovette® (13 x 90 mm), (4,9; 5,6 ml)
- [36] 15054 6 ml probówka z pokrywką (11,5 x 92 mm), Sarstedt®  
6 ml tube with cap (11,5 x 92 mm), Sarstedt®
- [36] 15120 5 ml probówka szklana (12 x 75 mm)  
5 ml glass tube (12 x 75 mm)
- [36] 15419 5 ml probówka z korkiem (12 x 85 mm), Sarstedt®  
5 ml tube with cap (12 x 85 mm), Sarstedt®

**14155**

- [48] \* Sarstedt S-Monovette® (11 x 92 mm), (4,5; 5 ml)
- [48] \* Sarstedt S-Monovette® (11 x 66 mm), (1,6; 2; 2,7; 3; 3,1 ml)
- [48] 15054 6 ml probówka z pokrywką (11,5 x 92 mm), Sarstedt®  
6 ml tube with cap (11,5 x 92 mm), Sarstedt®
- [48] 15119 7 ml probówka szklana (12 x 100 mm)  
7 ml glass tube (12 x 100 mm)
- [48] 15120 5 ml probówka szklana (12 x 75 mm)  
5 ml glass tube (12 x 75 mm)
- [48] 15419 5 ml probówka z korkiem (12 x 85 mm), Sarstedt®  
5 ml tube with cap (12 x 85 mm), Sarstedt®

**14156**

- [32] \* BD Vacutainer® (16 x 100 mm), (2,5-11 ml)
- [32] \* Greiner Vacuette® (16 x 100 mm), (7-9 ml)
- [32] \* 10 ml Thermo Nalgene® Oak Ridge (16 x 81,5 mm)
- [32] 15046 14 ml probówka z pokrywką (16,8 x 113,7 mm), Sarstedt®  
14 ml tube with cap (16,8 x 113,7 mm), Sarstedt®
- [32] 15053 10 ml probówka z pokrywką (16 x 106 mm)  
10 ml tube with cap (16 x 106 mm)
- [32] 15118 10 ml probówka szklana (16 x 100 mm)  
10 ml glass tube (16 x 100 mm)

**14157**

- [16] \* BD Vacutainer® (16 x 100 mm), (2,5-11 ml)
- [16] \* Greiner Vacuette® (16 x 100 mm), (7-9 ml)
- [16] \* Sarstedt S-Monovette® (15 x 92 mm), (7,5; 8,2; 8,5 ml)
- [16] \* Sarstedt S-Monovette® (16 x 92 mm), (9; 10 ml)
- [16] 15048 15 ml Thermo Nalgene® (16 x 113 mm)  
15 ml Thermo Nalgene® (16 x 113 mm)
- [16] 15053 10 ml probówka z pokrywką (16 x 106 mm)  
10 ml tube with cap (16 x 106 mm)
- [16] 15118 10 ml probówka szklana (16 x 100 mm)  
10 ml glass tube (16 x 100 mm)
- [16] \* 13 ml probówka (ø16x100mm), Sarstedt® nr 62.515.006  
13 ml tube (ø16 x 100 mm), Sarstedt® no. 62.515.006

**14158**

- [28] \* 2-1,5 ml probówka (10,8x41,8 mm), Eppendorf®; [15011], 2 ml (10,8x41,8 mm); [15128], 1,5ml (10,8x40,5 mm)  
2-1,5 ml tube (10,8x41,8 mm), Eppendorf®; [15011], 2 ml (10,8x41,8 mm); [15128], 1,5ml (10,8x40,5 mm)

**14160**

- [12] 15055 30 ml probówka z pokrywką (25,4 x 103,2 mm)  
30 ml tube with cap (25,4 x 103,2 mm)
- [12] 15117 25 ml probówka szklana (25 x 100 mm)  
25 ml glass tube (25 x 100 mm)

\* probówka niedostępna w ofercie MPW lub dostępny odpowiednik (np:[15050]), patrz kolumna z prawej  
tube is not offered by MPW or equivalent is available (e.g. [15050]), see column on the right

<b>A. Wyposażenie dodatkowe/Optional accessories</b>	
<b>14175</b>	
[4]	15175 250 ml butelka płaskodenna (62 x 122 mm), Herolab® nr 25 34 21 250 ml bottle, flat bottom (62 x 122 mm), Herolab® no. 25 34 21
[4]	15176 250 ml butelka płaskodenna (62 x 122 mm), Herolab® nr 25 34 01 250 ml bottle, flat bottom (62 x 122 mm), Herolab® no. 25 34 01
<b>14151+14159</b>	
[4]	15116 50 ml probówka szklana (35 x 100 mm) 50 ml glass tube (35 x 100 mm)
<b>12285</b>	
<b>RPM 4500, RCF 2626, Rmax 116, <math>\alpha</math> 90</b>	
<b>13286</b>	
<b>bez wkładki/without adapter</b>	
[8]	15102 płytka titracyjna MTP 28,8ml (86x128x15/17,5 mm) microtiter plate MTP 28,8 ml (86 x 128 x 15/17,5 mm)
[2]	* płytka titracyjna DWP 96/2000µl (127,8x85,5x44,1 mm) deepwell plate DWP 96/2000µl (127,8 x 85,5 x 44,1 mm)
<b>12300</b>	
<b>RPM 13000, RCF 16816, Rmax 89, <math>\alpha</math> 90</b>	
<b>bez pojemnika/without bucket</b>	
<b>bez wkładki/without adapter</b>	
[24]	15100 37 µl kapilara hematokrytowa (1,4 x 75 mm) 37 µl micro-hematocrit capillary tube (1,4 x 75 mm)
<b>12352</b>	
<b>RPM 4800, RCF 4405, Rmax 171, <math>\alpha</math> 90</b>	
<b>13352</b>	
<b>14050</b>	
[16]	* 50 ml probówka z dnem stożkowym z zakrętką (30 x 117 mm), Falcon®; [15052] 50ml (30 x 117mm) 50 ml tube, conical bottom, with cap (30 x 117 mm), Falcon®; [15052] 50ml Sarstedt® (30 x 117 mm)
[16]	* 50 ml probówka z dnem stożkowym bez rantu (30 x 115 mm), Greiner® 50 ml tube, conical bottom, without skirt (30 x 115 mm), Greiner®
<b>14051</b>	
[12]	* 50 ml probówka z dnem stożkowym z zakrętką (30 x 117 mm), Falcon®; [15052] 50ml (30 x 117mm) 50 ml tube, conical bottom, with cap (30 x 117 mm), Falcon®; [15052] 50ml Sarstedt® (30 x 117 mm)
[12]	* 50 ml probówka z dnem stożkowym bez rantu (30 x 115 mm), Greiner® 50 ml tube, conical bottom, without skirt (30 x 115 mm), Greiner®
<b>14250+14017</b>	
[4]	15129 250 ml butelka okrągłodenna (62 x 122 mm), Herolab® nr 25 34 43 250 ml round-bottom bottle (62 x 122 mm), Herolab® no. 25 34 43
<b>14310</b>	
[4]	15115 100 ml probówka szklana (44 x 100 mm) 100 ml glass tube (44 x 100 mm)
[4]	15040 100 ml probówka z pokrywką (45,2 x 103,7 mm) 100 ml tube with cap (45,2 x 103,7 mm)
<b>14311</b>	
[8]	* 50 ml probówka z dnem stożkowym z rantem (30 x 115 mm), Greiner® 50 ml tube, conical bottom, skirted (30 x 115 mm), Greiner®
<b>14312</b>	
[12]	15116 50 ml probówka szklana (35 x 100 mm) 50 ml glass tube (35 x 100 mm)
<b>14313</b>	
[76]	* BD Vacutainer® (13 x 75 mm), (1,6-5,3 ml)
[76]	* BD Vacutainer® (13 x 100 mm), (4-7 ml)
[76]	* Greiner Vacuette® (13 x 100 mm), (3,5-6 ml)
[76]	* Sarstedt S-Monovette® (11 x 66 mm), (1,6; 2; 2,7; 3; 3,1 ml)
[76]	* Sarstedt S-Monovette® (11 x 92 mm), (4,5; 5 ml)
[76]	15419 5 ml probówka z korkiem (12 x 85 mm), Sarstedt® 5 ml tube with cap (12 x 85 mm), Sarstedt®
[76]	15054 6 ml probówka z pokrywką (11,5 x 92 mm), Sarstedt® 6 ml tube with cap (11,5 x 92 mm), Sarstedt®

\* probówka niedostępna w ofercie MPW lub dostępny odpowiednik (np:[15050]), patrz kolumna z prawej  
tube is not offered by MPW or equivalent is available (e.g. [15050]), see column on the right

<b>A. Wyposażenie dodatkowe/Optional accessories</b>		
<b>14314</b>		
[76]	*	BD Vacutainer® (13 x 75 mm), (1,6-5,3 ml)
[76]	*	Greiner Vacuette® (13 x 75 mm), (1-4,5 ml)
[76]	*	Sarstedt S-Monovette® (11 x 66 mm), (1,6; 2; 2,7; 3; 3,1 ml)
<b>14315</b>		
[32]	*	15 ml probówka z dnem stożkowym z zakrętką (17 x 120 mm), Falcon®; [15050], 15ml (17 x 120 mm) 15 ml tube, conical bottom, with cap (17 x 120 mm), Falcon®; [15050] 15ml Sarstedt®(17 x 120 mm)
<b>14315+14324</b>		
[32]	*	5 ml probówka z korkiem wciskany (17 x 54,2 mm), Eppendorf® 5 ml tube with snap cap (17 x 54,2 mm), Eppendorf®
[32]	*	5 ml probówka z korkiem zakręcany (17 x 66 mm), Eppendorf® 5 ml tube with screw cap (17 x 66 mm), Eppendorf®
<b>14316</b>		
[60]	*	BD Vacutainer® (16 x 100 mm), (2,5-11 ml)
[60]	*	Greiner Vacuette® (16 x 100 mm), (7-9 ml)
[60]	15053	10 ml probówka z pokrywką (16 x 106 mm) 10 ml tube with cap (16 x 106 mm)
[60]	15118	10 ml probówka szklana (16 x 100 mm) 10 ml glass tube (16 x 100 mm)
[60]	*	Sarstedt S-Monovette® (15 x 92 mm), (7,5; 8,2; 8,5 ml)
[60]	*	Sarstedt S-Monovette® (15 x 75 mm), (4; 4,3; 5,5 ml)
[60]	*	10 ml Thermo Nalgene® Oak Ridge (16 x 81,5 mm)
[60]	15046	14 ml probówka z pokrywką (16,8 x 113,7 mm), Sarstedt® 14 ml tube with cap (16,8 x 113,7 mm), Sarstedt®
<b>14317</b>		
[28]	*	15 ml probówka z dnem stożkowym z zakrętką (17 x 120 mm), Falcon®; [15050], 15ml (17 x 120 mm) 15 ml tube, conical bottom, with cap (17 x 120 mm), Falcon®; [15050] 15ml Sarstedt®(17 x 120 mm)
<b>14317+14324</b>		
[28]	*	5 ml probówka z korkiem wciskany (17 x 54,2 mm), Eppendorf® 5 ml tube with snap cap (17 x 54,2 mm), Eppendorf®
[28]	*	5 ml probówka z korkiem zakręcany (17 x 66 mm), Eppendorf® 5 ml tube with screw cap (17 x 66 mm), Eppendorf®
<b>14318</b>		
[104]	15119	7 ml probówka szklana (12 x 100 mm) 7 ml glass tube (12 x 100 mm)
[104]	15120	5 ml probówka szklana (12 x 75 mm) 5 ml glass tube (12 x 75 mm)
[104]	*	Sarstedt S-Monovette® (11 x 92 mm), (4,5; 5 ml)
[104]	15054	6 ml probówka z pokrywką (11,5 x 92 mm), Sarstedt® 6 ml tube with cap (11,5 x 92 mm), Sarstedt®
[104]	*	Sarstedt S-Monovette® (11 x 66 mm), (1,6; 2; 2,7; 3; 3,1 ml)
[104]	15419	5 ml probówka z korkiem (12 x 85 mm), Sarstedt® 5 ml tube with cap (12 x 85 mm), Sarstedt®
<b>14319</b>		
[28]	*	28 ml Thermo Nalgene® Oak Ridge (25,4 x 101,8 mm)
[28]	15055	30 ml probówka z pokrywką (25,4 x 103,2 mm) 30 ml tube with cap (25,4 x 103,2 mm)
[28]	15056	30 ml Thermo Nalgene® Oak Ridge (25,5 x 94,3 mm) 30 ml Thermo Nalgene® Oak Ridge (25,5 x 94,3 mm)
[28]	15117	25 ml probówka szklana (25 x 100 mm) 25 ml glass tube (25 x 100 mm)
[28]	15424	30 ml probówka z pokrywką (25,5 x 94 mm), Nalgene® 30 ml tube with cap (25,5 x 94 mm), Nalgene®
[12]	15222	30 ml probówka z pokrywką (25 x 94mm), Sterilin® 30 ml tube with cap (25 x 94 mm), Sterilin®
[12]	15223	30 ml probówka z pokrywką (25 x 94 mm), Sterilin® 30 ml tube with cap (25 x 94 mm), Sterilin®

<b>A. Wyposażenie dodatkowe/Optional accessories</b>	
<b>14320</b>	
[48]	* BD Vacutainer® (16 x 100 mm), (2,5-11 ml)
[48]	* Greiner Vacuette® (16 x 100 mm), (7-9 ml)
[48]	* Sarstedt S-Monovette® (15 x 92 mm), (7,5; 8,2; 8,5 ml)
[48]	* Sarstedt S-Monovette® (16 x 92 mm), (9; 10 ml)
[48]	* Sarstedt S-Monovette® (15 x 75 mm), (4; 4,3; 5,5 ml)
[48]	* 10 ml Thermo Nalgene® Oak Ridge (16 x 81,5 mm)
[48] 15046	14 ml próbówka z pokrywką (16,8 x 113,7 mm), Sarstedt® 14 ml tube with cap (16,8 x 113,7 mm), Sarstedt®
[48] 15048	15 ml Thermo Nalgene® (16 x 113 mm) 15 ml Thermo Nalgene® (16 x 113 mm)
[48] 15053	10 ml próbówka z pokrywką (16 x 106 mm) 10 ml tube with cap (16 x 106 mm)
[48] 15118	10 ml próbówka szklana (16 x 100 mm) 10 ml glass tube (16 x 100 mm)
[48] 15121	10 ml próbówka z dnem okrągłym i pokrywką (17 x 70 mm) 10 ml tube, round bottom, with cap (17 x 70 mm)
[48]	* 13 ml próbówka (ø16x100mm), Sarstedt® nr 62.515.006 13 ml tube (ø16 x 100 mm), Sarstedt® no. 62.515.006
<b>14321</b>	
[16] 15051	50 ml Thermo Nalgene® Oak Ridge (28,8 x 106,7 mm) 50 ml Thermo Nalgene® Oak Ridge (28,8 x 106,7 mm)
[16]	* 50 ml próbówka Advanced Oak Ridge (29x102 mm), Herolab® nr 25 32 11 50 ml tube, Advanced Oak Ridge (29 x 102 mm), Herolab® no. 25 32 11
<b>14322</b>	
[72]	* 2-1,5 ml próbówka (10,8x41,8 mm), Eppendorf®; [15011], 2 ml (10,8x41,8 mm); [15128], 1,5ml (10,8x40,5 mm) 2-1,5 ml tube (10,8x41,8 mm), Eppendorf®; [15011], 2 ml (10,8x41,8 mm); [15128], 1,5ml (10,8x40,5 mm)
<b>14323</b>	
[4] 15440	200 ml butelka płaskodenna (56 x 112 mm), Herolab® nr 25 33 73 200 ml bottle, flat bottom (56 x 112 mm), Herolab® no. 25 33 73
<b>14325</b>	
[68]	* BD Vacutainer® (13 x 75 mm), (1,6-5,3 ml)
[68]	* Sarstedt S-Monovette® (13 x 90 mm), (4,9; 5,6 ml)
[68]	* Greiner Vacuette® (13 x 100 mm), (3,5-6 ml)
[68]	* BD Vacutainer® (13 x 100 mm), (4-7 ml)
[68]	* Greiner Vacuette® (13 x 75 mm), (1-4,5 ml)
[68]	* Sarstedt S-Monovette® (13 x 75 mm), (2,7; 3; 4,3 ml)
[68]	* Sarstedt S-Monovette® (11 x 66 mm), (1,6; 2; 2,7; 3; 3,1 ml)
[68]	* Sarstedt S-Monovette® (11 x 92 mm), (4,5; 5 ml)
[68] 15419	5 ml próbówka z korkiem (12 x 85 mm), Sarstedt® 5 ml tube with cap (12 x 85 mm), Sarstedt®
[68] 15054	6 ml próbówka z pokrywką (11,5 x 92 mm), Sarstedt® 6 ml tube with cap (11,5 x 92 mm), Sarstedt®
[68]	* Sarstedt S-Monovette® (13 x 65 mm), (2,6; 2,9; 3,4; 3,8 ml)
<b>14250+14175</b>	
[4] 15175	250 ml butelka płaskodenna (62 x 122 mm), Herolab® nr 25 34 21 250 ml bottle, flat bottom (62 x 122 mm), Herolab® no. 25 34 21
[4] 15176	250 ml butelka płaskodenna (62 x 122 mm), Herolab® nr 25 34 01 250 ml bottle, flat bottom (62 x 122 mm), Herolab® no. 25 34 01
<b>13353C</b>	
<b>14051</b>	
[12]	* 50 ml próbówka z dnem stożkowym z zakrętką (30 x 117 mm), Falcon®; [15052] 50ml (30 x 117mm) 50 ml tube, conical bottom, with cap (30 x 117 mm), Falcon®; [15052] 50ml Sarstedt® (30 x 117 mm)
[12]	* 50 ml próbówka z dnem stożkowym bez rantu (30 x 115 mm), Greiner® 50 ml tube, conical bottom, without skirt (30 x 115 mm), Greiner®
<b>14250+14017</b>	
[4] 15129	250 ml butelka okrągłodenna (62 x 122 mm), Herolab® nr 25 34 43 250 ml round-bottom bottle (62 x 122 mm), Herolab® no. 25 34 43
<b>14310</b>	
[4] 15115	100 ml próbówka szklana (44 x 100 mm) 100 ml glass tube (44 x 100 mm)
[4] 15040	100 ml próbówka z pokrywką (45,2 x 103,7 mm) 100 ml tube with cap (45,2 x 103,7 mm)
<b>14311</b>	
[8]	* 50 ml próbówka z dnem stożkowym z rantem (30 x 115 mm), Greiner® 50 ml tube, conical bottom, skirted (30 x 115 mm), Greiner®
<b>14312</b>	
[12] 15116	50 ml próbówka szklana (35 x 100 mm) 50 ml glass tube (35 x 100 mm)



<b>A. Wyposażenie dodatkowe/Optional accessories</b>		
<b>14313</b>		
[76]	*	BD Vacutainer® (13 x 75 mm), (1,6-5,3 ml)
[76]	*	BD Vacutainer® (13 x 100 mm), (4-7 ml)
[76]	*	Greiner Vacuette® (13 x 100 mm), (3,5-6 ml)
[76]	*	Sarstedt S-Monovette® (11 x 66 mm), (1,6; 2; 2,7; 3; 3,1 ml)
[76]	*	Sarstedt S-Monovette® (11 x 92 mm), (4,5; 5 ml)
[76]	15419	5 ml probówka z korkiem (12 x 85 mm), Sarstedt® 5 ml tube with cap (12 x 85 mm), Sarstedt®
[76]	15054	6 ml probówka z pokrywką (11,5 x 92 mm), Sarstedt® 6 ml tube with cap (11,5 x 92 mm), Sarstedt®
<b>14314</b>		
[76]	*	BD Vacutainer® (13 x 75 mm), (1,6-5,3 ml)
[76]	*	Greiner Vacuette® (13 x 75 mm), (1-4,5 ml)
[76]	*	Sarstedt S-Monovette® (11 x 66 mm), (1,6; 2; 2,7; 3; 3,1 ml)
<b>14315+14324</b>		
[32]	*	5 ml probówka z korkiem wciskany (17 x 54,2 mm), Eppendorf® 5 ml tube with snap cap (17 x 54,2 mm), Eppendorf®
[32]	*	5 ml probówka z korkiem zakręcany (17 x 66 mm), Eppendorf® 5 ml tube with screw cap (17 x 66 mm), Eppendorf®
<b>14316</b>		
[60]	*	BD Vacutainer® (16 x 100 mm), (2,5-11 ml)
[60]	*	Greiner Vacuette® (16 x 100 mm), (7-9 ml)
[60]	15053	10 ml probówka z pokrywką (16 x 106 mm) 10 ml tube with cap (16 x 106 mm)
[60]	15118	10 ml probówka szklana (16 x 100 mm) 10 ml glass tube (16 x 100 mm)
[60]	*	Sarstedt S-Monovette® (15 x 92 mm), (7,5; 8,2; 8,5 ml)
[60]	*	Sarstedt S-Monovette® (15 x 75 mm), (4; 4,3; 5,5 ml)
[60]	*	10 ml Thermo Nalgene® Oak Ridge (16 x 81,5 mm)
[60]	15046	14 ml probówka z pokrywką (16,8 x 113,7 mm), Sarstedt® 14 ml tube with cap (16,8 x 113,7 mm), Sarstedt®
<b>14317</b>		
[28]	*	15 ml probówka z dnem stożkowym z zakrętką (17 x 120 mm), Falcon®; [15050], 15ml (17 x 120 mm) 15 ml tube, conical bottom, with cap (17 x 120 mm), Falcon®; [15050] 15ml Sarstedt®(17 x 120 mm)
<b>14317+14324</b>		
[28]	*	5 ml probówka z korkiem wciskany (17 x 54,2 mm), Eppendorf® 5 ml tube with snap cap (17 x 54,2 mm), Eppendorf®
[28]	*	5 ml probówka z korkiem zakręcany (17 x 66 mm), Eppendorf® 5 ml tube with screw cap (17 x 66 mm), Eppendorf®
<b>14318</b>		
[104]	15119	7 ml probówka szklana (12 x 100 mm) 7 ml glass tube (12 x 100 mm)
[104]	15120	5 ml probówka szklana (12 x 75 mm) 5 ml glass tube (12 x 75 mm)
[104]	*	Sarstedt S-Monovette® (11 x 92 mm), (4,5; 5 ml)
[104]	15054	6 ml probówka z pokrywką (11,5 x 92 mm), Sarstedt® 6 ml tube with cap (11,5 x 92 mm), Sarstedt®
[104]	*	Sarstedt S-Monovette® (11 x 66 mm), (1,6; 2; 2,7; 3; 3,1 ml)
[104]	15419	5 ml probówka z korkiem (12 x 85 mm), Sarstedt® 5 ml tube with cap (12 x 85 mm), Sarstedt®
<b>14319</b>		
[28]	*	28 ml Thermo Nalgene® Oak Ridge (25,4 x 101,8 mm)
[28]	15055	30 ml probówka z pokrywką (25,4 x 103,2 mm) 30 ml tube with cap (25,4 x 103,2 mm)
[28]	15056	30 ml Thermo Nalgene® Oak Ridge (25,5 x 94,3 mm) 30 ml Thermo Nalgene® Oak Ridge (25,5 x 94,3 mm)
[28]	15117	25 ml probówka szklana (25 x 100 mm) 25 ml glass tube (25 x 100 mm)
[28]	15424	30 ml probówka z pokrywką (25,5 x 94 mm), Nalgene® 30 ml tube with cap (25,5 x 94 mm), Nalgene®
[12]	15222	30 ml probówka z pokrywką (25 x 94mm), Sterilin® 30 ml tube with cap (25 x 94 mm), Sterilin®
[12]	15223	30 ml probówka z pokrywką (25 x 94 mm), Sterilin® 30 ml tube with cap (25 x 94 mm), Sterilin®

<b>A. Wyposażenie dodatkowe/Optional accessories</b>	
<b>14320</b>	
[48]	* BD Vacutainer® (16 x 100 mm), (2,5-11 ml)
[48]	* Greiner Vacuette® (16 x 100 mm), (7-9 ml)
[48]	* Sarstedt S-Monovette® (15 x 92 mm), (7,5; 8,2; 8,5 ml)
[48]	* Sarstedt S-Monovette® (16 x 92 mm), (9; 10 ml)
[48]	* Sarstedt S-Monovette® (15 x 75 mm), (4; 4,3; 5,5 ml)
[48]	* 10 ml Thermo Nalgene® Oak Ridge (16 x 81,5 mm)
[48] 15046	14 ml probówka z pokrywką (16,8 x 113,7 mm), Sarstedt® 14 ml tube with cap (16,8 x 113,7 mm), Sarstedt®
[48] 15048	15 ml Thermo Nalgene® (16 x 113 mm) 15 ml Thermo Nalgene® (16 x 113 mm)
[48] 15053	10 ml probówka z pokrywką (16 x 106 mm) 10 ml tube with cap (16 x 106 mm)
[48] 15118	10 ml probówka szklana (16 x 100 mm) 10 ml glass tube (16 x 100 mm)
[48] 15121	10 ml probówka z dnem okrągłym i pokrywką (17 x 70 mm) 10 ml tube, round bottom, with cap (17 x 70 mm)
[48]	* 13 ml probówka (Ø16x100mm), Sarstedt® nr 62.515.006 13 ml tube (Ø16 x 100 mm), Sarstedt® no. 62.515.006
<b>14321</b>	
[16] 15051	50 ml Thermo Nalgene® Oak Ridge (28,8 x 106,7 mm) 50 ml Thermo Nalgene® Oak Ridge (28,8 x 106,7 mm)
[16]	* 50 ml probówka Advanced Oak Ridge (29x102 mm), Herolab® nr 25 32 11 50 ml tube, Advanced Oak Ridge (29 x 102 mm), Herolab® no. 25 32 11
<b>14322</b>	
[72]	* 2-1,5 ml probówka (10,8x41,8 mm), Eppendorf®; [15011], 2 ml (10,8x41,8 mm); [15128], 1,5ml (10,8x40,5 mm) 2-1,5 ml tube (10,8x41,8 mm), Eppendorf®; [15011], 2 ml (10,8x41,8 mm); [15128], 1,5ml (10,8x40,5 mm)
<b>14323</b>	
[4] 15440	200 ml butelka płaskodenna (56 x 112 mm), Herolab® nr 25 33 73 200 ml bottle, flat bottom (56 x 112 mm), Herolab® no. 25 33 73
<b>14325</b>	
[68]	* BD Vacutainer® (13 x 75 mm), (1,6-5,3 ml)
[68]	* Sarstedt S-Monovette® (13 x 90 mm), (4,9; 5,6 ml)
[68]	* Greiner Vacuette® (13 x 100 mm), (3,5-6 ml)
[68]	* BD Vacutainer® (13 x 100 mm), (4-7 ml)
[68]	* Greiner Vacuette® (13 x 75 mm), (1-4,5 ml)
[68]	* Sarstedt S-Monovette® (13 x 75 mm), (2,7; 3; 4,3 ml)
[68]	* Sarstedt S-Monovette® (11 x 66 mm), (1,6; 2; 2,7; 3; 3,1 ml)
[68]	* Sarstedt S-Monovette® (11 x 92 mm), (4,5; 5 ml)
[68] 15419	5 ml probówka z korkiem (12 x 85 mm), Sarstedt® 5 ml tube with cap (12 x 85 mm), Sarstedt®
[68] 15054	6 ml probówka z pokrywką (11,5 x 92 mm), Sarstedt® 6 ml tube with cap (11,5 x 92 mm), Sarstedt®
[68]	* Sarstedt S-Monovette® (13 x 65 mm), (2,6; 2,9; 3,4; 3,8 ml)
<b>14250+14175</b>	
[4] 15175	250 ml butelka płaskodenna (62 x 122 mm), Herolab® nr 25 34 21 250 ml bottle, flat bottom (62 x 122 mm), Herolab® no. 25 34 21
[4] 15176	250 ml butelka płaskodenna (62 x 122 mm), Herolab® nr 25 34 01 250 ml bottle, flat bottom (62 x 122 mm), Herolab® no. 25 34 01
<b>12436</b>	
<b>RPM 5200, RCF 4414, Rmax 146, <math>\alpha</math> 90</b>	
<b>bez pojemnika/without bucket</b>	
<b>14450</b>	
[32]	* 2-1,5 ml probówka (10,8x41,8 mm), Eppendorf®; [15011], 2 ml (10,8x41,8 mm); [15128], 1,5ml (10,8x40,5 mm) 2-1,5 ml tube (10,8x41,8 mm), Eppendorf®; [15011], 2 ml (10,8x41,8 mm); [15128], 1,5ml (10,8x40,5 mm)
<b>13437</b>	
<b>14072</b>	
[4] 15116	50 ml probówka szklana (35 x 100 mm) 50 ml glass tube (35 x 100 mm)

<b>A. Wyposażenie dodatkowe/Optional accessories</b>	
<b>14106</b>	
[28]	* Greiner Vacuette® (13 x 75 mm), (1-4,5 ml)
[28]	* Sarstedt S-Monovette® (13 x 75 mm), (2,7; 3; 4,3 ml)
[28]	* BD Vacutainer® (13 x 100 mm), (4-7 ml)
[28]	* Greiner Vacuette® (13 x 100 mm), (3,5-6 ml)
[28]	* Sarstedt S-Monovette® (11 x 92 mm), (4,5; 5 ml)
[28]	* Sarstedt S-Monovette® (13 x 90 mm), (4,9; 5,6 ml)
[28]	15120 5 ml probówka szklana (12 x 75 mm) 5 ml glass tube (12 x 75 mm)
[28]	15419 5 ml probówka z korkiem (12 x 85 mm), Sarstedt® 5 ml tube with cap (12 x 85 mm), Sarstedt®
[28]	15054 6 ml probówka z pokrywką (11,5 x 92 mm), Sarstedt® 6 ml tube with cap (11,5 x 92 mm), Sarstedt®
[28]	15119 7 ml probówka szklana (12 x 100 mm) 7 ml glass tube (12 x 100 mm)
<b>14108</b>	
[28]	* Sarstedt S-Monovette® (15 x 75 mm), (4; 4,3; 5,5 ml)
[28]	* BD Vacutainer® (16 x 100 mm), (2,5-11 ml)
[28]	* Greiner Vacuette® (16 x 100 mm), (7-9 ml)
[28]	* Sarstedt S-Monovette® (15 x 92 mm), (7,5; 8,2; 8,5 ml)
[28]	* 10 ml Thermo Nalgene® Oak Ridge (16 x 81,5 mm)
[28]	15048 15 ml Thermo Nalgene® (16 x 113 mm) 15 ml Thermo Nalgene® (16 x 113 mm)
[28]	15053 10 ml probówka z pokrywką (16 x 106 mm) 10 ml tube with cap (16 x 106 mm)
[28]	15118 10 ml probówka szklana (16 x 100 mm) 10 ml glass tube (16 x 100 mm)
<b>14109</b>	
[28]	* BD Vacutainer® (13 x 75 mm), (1,6-5,3 ml)
[28]	* Greiner Vacuette® (13 x 75 mm), (1-4,5 ml)
[28]	* Sarstedt S-Monovette® (11 x 66 mm), (1,6; 2; 2,7; 3; 3,1 ml)
[28]	* Sarstedt S-Monovette® (13 x 65 mm), (2,6; 2,9; 3,4; 3,8 ml)
[28]	* Sarstedt S-Monovette® (13 x 75 mm), (2,7; 3; 4,3 ml)
[28]	* BD Vacutainer® (13 x 100 mm), (4-7 ml)
[28]	* Greiner Vacuette® (13 x 100 mm), (3,5-6 ml)
[28]	* Sarstedt S-Monovette® (11 x 92 mm), (4,5; 5 ml)
[28]	* Sarstedt S-Monovette® (13 x 90 mm), (4,9; 5,6 ml)
[28]	15120 5 ml probówka szklana (12 x 75 mm) 5 ml glass tube (12 x 75 mm)
[28]	15419 5 ml probówka z korkiem (12 x 85 mm), Sarstedt® 5 ml tube with cap (12 x 85 mm), Sarstedt®
[28]	15054 6 ml probówka z pokrywką (11,5 x 92 mm), Sarstedt® 6 ml tube with cap (11,5 x 92 mm), Sarstedt®
[28]	15119 7 ml probówka szklana (12 x 100 mm) 7 ml glass tube (12 x 100 mm)
<b>14110</b>	
[28]	* BD Vacutainer® (16 x 100 mm), (2,5-11 ml)
[28]	* Greiner Vacuette® (16 x 100 mm), (7-9 ml)
[28]	* 10 ml Thermo Nalgene® Oak Ridge (16 x 81,5 mm)
[28]	15048 15 ml Thermo Nalgene® (16 x 113 mm) 15 ml Thermo Nalgene® (16 x 113 mm)
[28]	15053 10 ml probówka z pokrywką (16 x 106 mm) 10 ml tube with cap (16 x 106 mm)
[28]	15118 10 ml probówka szklana (16 x 100 mm) 10 ml glass tube (16 x 100 mm)
[28]	15046 14 ml probówka z pokrywką (16,8 x 113,7 mm), Sarstedt® 14 ml tube with cap (16,8 x 113,7 mm), Sarstedt®
<b>14113</b>	
[4]	15051 50 ml Thermo Nalgene® Oak Ridge (28,8 x 106,7 mm) 50 ml Thermo Nalgene® Oak Ridge (28,8 x 106,7 mm)
[4]	* 50 ml probówka z dnem stożkowym z zakrętką (30 x 117 mm), Falcon®; [15052] 50ml (30 x 117mm) 50 ml tube, conical bottom, with cap (30 x 117 mm), Falcon®; [15052] 50ml Sarstedt® (30 x 117 mm)
[4]	* 50 ml probówka z dnem stożkowym bez rantu (30 x 115 mm), Greiner® 50 ml tube, conical bottom, without skirt (30 x 115 mm), Greiner®
<b>14197</b>	
[4]	15115 100 ml probówka szklana (44 x 100 mm) 100 ml glass tube (44 x 100 mm)
[4]	15040 100 ml probówka z pokrywką (45,2 x 103,7 mm) 100 ml tube with cap (45,2 x 103,7 mm)
<b>14441</b>	
[48]	15119 7 ml probówka szklana (12 x 100 mm) 7 ml glass tube (12 x 100 mm)

<b>A. Wyposażenie dodatkowe/Optional accessories</b>	
<b>14446</b>	
[48]	* Sarstedt S-Monovette® (11 x 92 mm), (4,5; 5 ml)
[48]	* Sarstedt S-Monovette® (11 x 66 mm), (1,6; 2; 2,7; 3; 3,1 ml)
[48]	15054 6 ml probówka z pokrywką (11,5 x 92 mm), Sarstedt® 6 ml tube with cap (11,5 x 92 mm), Sarstedt®
[48]	15119 7 ml probówka szklana (12 x 100 mm) 7 ml glass tube (12 x 100 mm)
[48]	15120 5 ml probówka szklana (12 x 75 mm) 5 ml glass tube (12 x 75 mm)
[48]	15419 5 ml probówka z korkiem (12 x 85 mm), Sarstedt® 5 ml tube with cap (12 x 85 mm), Sarstedt®
<b>14447</b>	
[48]	15016 Sarstedt S-Monovette® (8 x 66 mm), (1,1; 1,2; 1,4 ml) Sarstedt S-Monovette® (8 x 66 mm), (1,1; 1,2; 1,4 ml)
<b>14449</b>	
[16]	* BD Vacutainer® (16 x 100 mm), (2,5-11 ml)
[16]	* Sarstedt S-Monovette® (16 x 92 mm), (9; 10 ml)
[16]	15053 10 ml probówka z pokrywką (16 x 106 mm) 10 ml tube with cap (16 x 106 mm)
[16]	* 13 ml probówka (Ø16x100mm), Sarstedt® nr 62.515.006 13 ml tube (Ø16 x 100 mm), Sarstedt® no. 62.515.006
<b>bez wkładki/without adapter</b>	
[4]	15440 200 ml butelka płaskodenna (56 x 112 mm), Herolab® nr 25 33 73 200 ml bottle, flat bottom (56 x 112 mm), Herolab® no. 25 33 73
<b>14111 NIE AUTOKLAWOWAĆ/DO NOT AUTOCLAVE</b>	
[20]	* Sarstedt S-Monovette® (15 x 75 mm), (4; 4,3; 5,5 ml)
[20]	* 10 ml Thermo Nalgene® Oak Ridge (16 x 81,5 mm)
[20]	15053 10 ml probówka z pokrywką (16 x 106 mm) 10 ml tube with cap (16 x 106 mm)
[20]	15118 10 ml probówka szklana (16 x 100 mm) 10 ml glass tube (16 x 100 mm)
[20]	* 13 ml probówka (Ø16x100mm), Sarstedt® nr 62.515.006 13 ml tube (Ø16 x 100 mm), Sarstedt® no. 62.515.006
<b>13042</b>	
<b>14043</b>	
[4]	15119 7 ml probówka szklana (12 x 100 mm) 7 ml glass tube (12 x 100 mm)
[4]	15120 5 ml probówka szklana (12 x 75 mm) 5 ml glass tube (12 x 75 mm)
<b>14089</b>	
[8]	* 15 ml probówka z dnem stożkowym z zakrętką (17 x 120 mm), Falcon®; [15050], 15ml (17 x 120 mm) 15 ml tube, conical bottom, with cap (17 x 120 mm), Falcon®; [15050] 15ml Sarstedt®(17 x 120 mm)
<b>bez wkładki/without adapter</b>	
[8]	* 50 ml probówka z dnem stożkowym z zakrętką (30 x 117 mm), Falcon®; [15052] 50ml (30 x 117mm) 50 ml tube, conical bottom, with cap (30 x 117 mm), Falcon®; [15052] 50ml Sarstedt® (30 x 117 mm)
[8]	* 50 ml probówka z dnem stożkowym bez rantu (30 x 115 mm), Greiner® 50 ml tube, conical bottom, without skirt (30 x 115 mm), Greiner®
<b>13044</b>	
<b>bez wkładki/without adapter</b>	
[16]	* BD Vacutainer® (16 x 100 mm), (2,5-11 ml)
[16]	* Sarstedt S-Monovette® (15 x 92 mm), (7,5; 8,2; 8,5 ml)
[16]	* Sarstedt S-Monovette® (16 x 92 mm), (9; 10 ml)
[16]	15053 10 ml probówka z pokrywką (16 x 106 mm) 10 ml tube with cap (16 x 106 mm)
[16]	15118 10 ml probówka szklana (16 x 100 mm) 10 ml glass tube (16 x 100 mm)
[16]	* 13 ml probówka (Ø16x100mm), Sarstedt® nr 62.515.006 13 ml tube (Ø16 x 100 mm), Sarstedt® no. 62.515.006
[16]	* 15 ml probówka z dnem stożkowym z zakrętką (17 x 120 mm), Falcon®; [15050], 15ml (17 x 120 mm) 15 ml tube, conical bottom, with cap (17 x 120 mm), Falcon®; [15050] 15ml Sarstedt®(17 x 120 mm)
<b>13045</b>	
<b>14043</b>	
[4]	* Greiner Vacuette® (13 x 75 mm), (1-4,5 ml)
[4]	15119 7 ml probówka szklana (12 x 100 mm) 7 ml glass tube (12 x 100 mm)
[4]	15120 5 ml probówka szklana (12 x 75 mm) 5 ml glass tube (12 x 75 mm)
<b>14089</b>	
[4]	* 15 ml probówka z dnem stożkowym z zakrętką (17 x 120 mm), Falcon®; [15050], 15ml (17 x 120 mm) 15 ml tube, conical bottom, with cap (17 x 120 mm), Falcon®; [15050] 15ml Sarstedt®(17 x 120 mm)

\* probówka niedostępna w ofercie MPW lub dostępny odpowiednik (np:[15050]), patrz kolumna z prawej  
tube is not offered by MPW or equivalent is available (e.g. [15050]), see column on the right

<b>A. Wyposażenie dodatkowe/Optional accessories</b>	
<b>bez wkładki/without adapter</b>	
[4]	* 50 ml probówka z dnem stożkowym z zakrętką (30 x 117 mm), Falcon®; [15052] 50ml (30 x 117mm) 50 ml tube, conical bottom, with cap (30 x 117 mm), Falcon®; [15052] 50ml Sarstedt® (30 x 117 mm)
[4]	* 50 ml probówka z dnem stożkowym bez rantu (30 x 115 mm), Greiner® 50 ml tube, conical bottom, without skirt (30 x 115 mm), Greiner®
<b>13593</b>	
<b>14024</b>	
[4]	* 15 ml probówka z dnem stożkowym z zakrętką (17 x 120 mm), Falcon®; [15050], 15ml (17 x 120 mm) 15 ml tube, conical bottom, with cap (17 x 120 mm), Falcon®; [15050] 15ml Sarstedt®(17 x 120 mm)
<b>14181</b>	
[20]	* Sarstedt S-Monovette® (11 x 66 mm), (1,6; 2; 2,7; 3; 3,1 ml)
[20]	* Sarstedt S-Monovette® (11 x 92 mm), (4,5; 5 ml)
[20]	15054 6 ml probówka z pokrywką (11,5 x 92 mm), Sarstedt® 6 ml tube with cap (11,5 x 92 mm), Sarstedt®
[20]	15119 7 ml probówka szklana (12 x 100 mm) 7 ml glass tube (12 x 100 mm)
[20]	15120 5 ml probówka szklana (12 x 75 mm) 5 ml glass tube (12 x 75 mm)
[20]	15419 5 ml probówka z korkiem (12 x 85 mm), Sarstedt® 5 ml tube with cap (12 x 85 mm), Sarstedt®
<b>14186</b>	
[16]	* BD Vacutainer® (13 x 75 mm), (1,6-5,3 ml)
[16]	* BD Vacutainer® (13 x 100 mm), (4-7 ml)
[16]	* Greiner Vacuette® (13 x 75 mm), (1-4,5 ml)
[16]	* Greiner Vacuette® (13 x 100 mm), (3,5-6 ml)
[16]	* Sarstedt S-Monovette® (11 x 66 mm), (1,6; 2; 2,7; 3; 3,1 ml)
[16]	* Sarstedt S-Monovette® (13 x 65 mm), (2,6; 2,9; 3,4; 3,8 ml)
[16]	* Sarstedt S-Monovette® (13 x 75 mm), (2,7; 3; 4,3 ml)
[16]	* Sarstedt S-Monovette® (11 x 92 mm), (4,5; 5 ml)
[16]	* Sarstedt S-Monovette® (13 x 90 mm), (4,9; 5,6 ml)
[16]	15054 6 ml probówka z pokrywką (11,5 x 92 mm), Sarstedt® 6 ml tube with cap (11,5 x 92 mm), Sarstedt®
[16]	15119 7 ml probówka szklana (12 x 100 mm) 7 ml glass tube (12 x 100 mm)
[16]	15120 5 ml probówka szklana (12 x 75 mm) 5 ml glass tube (12 x 75 mm)
[16]	15419 5 ml probówka z korkiem (12 x 85 mm), Sarstedt® 5 ml tube with cap (12 x 85 mm), Sarstedt®
<b>14187</b>	
[16]	* BD Vacutainer® (16 x 100 mm), (2,5-11 ml)
[16]	* Greiner Vacuette® (16 x 100 mm), (7-9 ml)
[16]	* Sarstedt S-Monovette® (15 x 92 mm), (7,5; 8,2; 8,5 ml)
[16]	* Sarstedt S-Monovette® (15 x 75 mm), (4; 4,3; 5,5 ml)
[16]	* 10 ml Thermo Nalgene® Oak Ridge (16 x 81,5 mm)
[16]	15048 15 ml Thermo Nalgene® (16 x 113 mm) 15 ml Thermo Nalgene® (16 x 113 mm)
[16]	15053 10 ml probówka z pokrywką (16 x 106 mm) 10 ml tube with cap (16 x 106 mm)
[16]	15118 10 ml probówka szklana (16 x 100 mm) 10 ml glass tube (16 x 100 mm)
[16]	15046 14 ml probówka z pokrywką (16,8 x 113,7 mm), Sarstedt® 14 ml tube with cap (16,8 x 113,7 mm), Sarstedt®
<b>14188</b>	
[4]	15115 100 ml probówka szklana (44 x 100 mm) 100 ml glass tube (44 x 100 mm)
[4]	15040 100 ml probówka z pokrywką (45,2 x 103,7 mm) 100 ml tube with cap (45,2 x 103,7 mm)
<b>14194</b>	
[12]	* 2-1,5 ml probówka (10,8x41,8 mm), Eppendorf®; [15011], 2 ml (10,8x41,8 mm); [15128], 1,5ml (10,8x40,5 mm) 2-1,5 ml tube (10,8x41,8 mm), Eppendorf®; [15011], 2 ml (10,8x41,8 mm); [15128], 1,5ml (10,8x40,5 mm)
<b>14226</b>	
[4]	* 50 ml probówka z dnem stożkowym z rantem (30 x 115 mm), Greiner® 50 ml tube, conical bottom, skirted (30 x 115 mm), Greiner®
<b>14189C</b>	
[4]	15051 50 ml Thermo Nalgene® Oak Ridge (28,8 x 106,7 mm) 50 ml Thermo Nalgene® Oak Ridge (28,8 x 106,7 mm)
[4]	* 50 ml probówka z dnem stożkowym z zakrętką (30 x 117 mm), Falcon®; [15052] 50ml (30 x 117mm) 50 ml tube, conical bottom, with cap (30 x 117 mm), Falcon®; [15052] 50ml Sarstedt® (30 x 117 mm)
[4]	* 50 ml probówka z dnem stożkowym bez rantu (30 x 115 mm), Greiner® 50 ml tube, conical bottom, without skirt (30 x 115 mm), Greiner®

<b>A. Wyposażenie dodatkowe/Optional accessories</b>	
<b>14190C</b>	
[4]	15055 30 ml probówka z pokrywką (25,4 x 103,2 mm) 30 ml tube with cap (25,4 x 103,2 mm)
[4]	15117 25 ml probówka szklana (25 x 100 mm) 25 ml glass tube (25 x 100 mm)
<b>14192C</b>	
[4]	15116 50 ml probówka szklana (35 x 100 mm) 50 ml glass tube (35 x 100 mm)
<b>13438C</b>	
<b>14072</b>	
[4]	15116 50 ml probówka szklana (35 x 100 mm) 50 ml glass tube (35 x 100 mm)
<b>14106</b>	
[28]	* Greiner Vacuette® (13 x 75 mm), (1-4,5 ml)
[28]	* Sarstedt S-Monovette® (13 x 75 mm), (2,7; 3; 4,3 ml)
[28]	* BD Vacutainer® (13 x 100 mm), (4-7 ml)
[28]	* Greiner Vacuette® (13 x 100 mm), (3,5-6 ml)
[28]	* Sarstedt S-Monovette® (11 x 92 mm), (4,5; 5 ml)
[28]	* Sarstedt S-Monovette® (13 x 90 mm), (4,9; 5,6 ml)
[28]	15120 5 ml probówka szklana (12 x 75 mm) 5 ml glass tube (12 x 75 mm)
[28]	15419 5 ml probówka z korkiem (12 x 85 mm), Sarstedt® 5 ml tube with cap (12 x 85 mm), Sarstedt®
[28]	15054 6 ml probówka z pokrywką (11,5 x 92 mm), Sarstedt® 6 ml tube with cap (11,5 x 92 mm), Sarstedt®
[28]	15119 7 ml probówka szklana (12 x 100 mm) 7 ml glass tube (12 x 100 mm)
<b>14108</b>	
[28]	* Sarstedt S-Monovette® (15 x 75 mm), (4; 4,3; 5,5 ml)
[28]	* BD Vacutainer® (16 x 100 mm), (2,5-11 ml)
[28]	* Greiner Vacuette® (16 x 100 mm), (7-9 ml)
[28]	* Sarstedt S-Monovette® (15 x 92 mm), (7,5; 8,2; 8,5 ml)
[28]	* 10 ml Thermo Nalgene® Oak Ridge (16 x 81,5 mm)
[28]	15053 10 ml probówka z pokrywką (16 x 106 mm) 10 ml tube with cap (16 x 106 mm)
[28]	15118 10 ml probówka szklana (16 x 100 mm) 10 ml glass tube (16 x 100 mm)
<b>14109</b>	
[28]	* BD Vacutainer® (13 x 75 mm), (1,6-5,3 ml)
[28]	* Greiner Vacuette® (13 x 75 mm), (1-4,5 ml)
[28]	* Sarstedt S-Monovette® (11 x 66 mm), (1,6; 2; 2,7; 3; 3,1 ml)
[28]	* Sarstedt S-Monovette® (13 x 65 mm), (2,6; 2,9; 3,4; 3,8 ml)
[28]	* Sarstedt S-Monovette® (13 x 75 mm), (2,7; 3; 4,3 ml)
[28]	* BD Vacutainer® (13 x 100 mm), (4-7 ml)
[28]	* Greiner Vacuette® (13 x 100 mm), (3,5-6 ml)
[28]	* Sarstedt S-Monovette® (11 x 92 mm), (4,5; 5 ml)
[28]	* Sarstedt S-Monovette® (13 x 90 mm), (4,9; 5,6 ml)
[28]	15120 5 ml probówka szklana (12 x 75 mm) 5 ml glass tube (12 x 75 mm)
[28]	15419 5 ml probówka z korkiem (12 x 85 mm), Sarstedt® 5 ml tube with cap (12 x 85 mm), Sarstedt®
[28]	15054 6 ml probówka z pokrywką (11,5 x 92 mm), Sarstedt® 6 ml tube with cap (11,5 x 92 mm), Sarstedt®
[28]	15119 7 ml probówka szklana (12 x 100 mm) 7 ml glass tube (12 x 100 mm)
<b>14110</b>	
[28]	* Sarstedt S-Monovette® (15 x 75 mm), (4; 4,3; 5,5 ml)
[28]	* BD Vacutainer® (16 x 100 mm), (2,5-11 ml)
[28]	* Sarstedt S-Monovette® (15 x 92 mm), (7,5; 8,2; 8,5 ml)
[28]	* 10 ml Thermo Nalgene® Oak Ridge (16 x 81,5 mm)
[28]	15053 10 ml probówka z pokrywką (16 x 106 mm) 10 ml tube with cap (16 x 106 mm)
[28]	15118 10 ml probówka szklana (16 x 100 mm) 10 ml glass tube (16 x 100 mm)
[28]	15046 14 ml probówka z pokrywką (16,8 x 113,7 mm), Sarstedt® 14 ml tube with cap (16,8 x 113,7 mm), Sarstedt®
<b>14113</b>	
[4]	15051 50 ml Thermo Nalgene® Oak Ridge (28,8 x 106,7 mm) 50 ml Thermo Nalgene® Oak Ridge (28,8 x 106,7 mm)
[4]	* 50 ml probówka z dnem stożkowym z zakrętką (30 x 117 mm), Falcon®; [15052] 50ml (30 x 117mm) 50 ml tube, conical bottom, with cap (30 x 117 mm), Falcon®; [15052] 50ml Sarstedt® (30 x 117 mm)
[4]	* 50 ml probówka z dnem stożkowym bez rantu (30 x 115 mm), Greiner® 50 ml tube, conical bottom, without skirt (30 x 115 mm), Greiner®

\* probówka niedostępna w ofercie MPW lub dostępny odpowiednik (np:[15050]), patrz kolumna z prawej  
tube is not offered by MPW or equivalent is available (e.g. [15050]), see column on the right

<b>A. Wyposażenie dodatkowe/Optional accessories</b>	
<b>14197</b>	
[4]	15115 100 ml probówka szklana (44 x 100 mm) 100 ml glass tube (44 x 100 mm)
[4]	15040 100 ml probówka z pokrywką (45,2 x 103,7 mm) 100 ml tube with cap (45,2 x 103,7 mm)
<b>14441</b>	
[48]	15119 7 ml probówka szklana (12 x 100 mm) 7 ml glass tube (12 x 100 mm)
<b>14446</b>	
[48]	* Sarstedt S-Monovette® (11 x 92 mm), (4,5; 5 ml)
[48]	* Sarstedt S-Monovette® (11 x 66 mm), (1,6; 2; 2,7; 3; 3,1 ml)
[48]	15054 6 ml probówka z pokrywką (11,5 x 92 mm), Sarstedt® 6 ml tube with cap (11,5 x 92 mm), Sarstedt®
[48]	15119 7 ml probówka szklana (12 x 100 mm) 7 ml glass tube (12 x 100 mm)
[48]	15120 5 ml probówka szklana (12 x 75 mm) 5 ml glass tube (12 x 75 mm)
[48]	15419 5 ml probówka z korkiem (12 x 85 mm), Sarstedt® 5 ml tube with cap (12 x 85 mm), Sarstedt®
<b>14447</b>	
[48]	15016 Sarstedt S-Monovette® (8 x 66 mm), (1,1; 1,2; 1,4 ml) Sarstedt S-Monovette® (8 x 66 mm), (1,1; 1,2; 1,4 ml)
<b>14449</b>	
[16]	* Sarstedt S-Monovette® (15 x 92 mm), (7,5; 8,2; 8,5 ml)
[16]	* Sarstedt S-Monovette® (16 x 92 mm), (9; 10 ml)
[16]	* Sarstedt S-Monovette® (15 x 75 mm), (4; 4,3; 5,5 ml)
[16]	15053 10 ml probówka z pokrywką (16 x 106 mm) 10 ml tube with cap (16 x 106 mm)
[16]	* 13 ml probówka (ø16x100mm), Sarstedt® nr 62.515.006 13 ml tube (ø16 x 100 mm), Sarstedt® no. 62.515.006
<b>bez wkładki/without adapter</b>	
[4]	15440 200 ml butelka płaskodenna (56 x 112 mm), Herolab® nr 25 33 73 200 ml bottle, flat bottom (56 x 112 mm), Herolab® no. 25 33 73
<b>14111 NIE AUTOKLAWOWAĆ/DO NOT AUTOCLAVE</b>	
[20]	* Sarstedt S-Monovette® (15 x 75 mm), (4; 4,3; 5,5 ml)
[20]	* 10 ml Thermo Nalgene® Oak Ridge (16 x 81,5 mm)
[20]	15053 10 ml probówka z pokrywką (16 x 106 mm) 10 ml tube with cap (16 x 106 mm)
[20]	15118 10 ml probówka szklana (16 x 100 mm) 10 ml glass tube (16 x 100 mm)
[20]	* 13 ml probówka (ø16x100mm), Sarstedt® nr 62.515.006 13 ml tube (ø16 x 100 mm), Sarstedt® no. 62.515.006
<b>12451</b>	
<b>RPM 3000, RCF 1036, Rmax 103, ɸ 90</b>	
<b>13307</b>	
<b>bez wkładki/without adapter</b>	
[2]	* płytki titracyjna DWP 96/2000µl (127,8x85,5x44,1 mm) deepwell plate DWP 96/2000µl (127,8 x 85,5 x 44,1 mm)
[6]	15102 płytki titracyjna MTP 28,8ml (86x128x15/17,5 mm) microtiter plate MTP 28,8 ml (86 x 128 x 15/17,5 mm)
<b>12452</b>	
<b>RPM 2500, RCF 769, Rmax 110, ɸ 90</b>	
<b>13606</b>	
<b>bez wkładki/without adapter</b>	
[4]	16610 system cytologiczny MPW® 2,2ml cytological system MPW® 2,2 ml

**A. Wyposażenie dodatkowe/Optional accessories****12582****RPM 3200, RCF 1809, Rmax 158,  $\alpha$  90****13583****14181**

[20]	*	Sarstedt S-Monovette® (11 x 66 mm), (1,6; 2; 2,7; 3; 3,1 ml)
[20]	15054	6 ml probówka z pokrywką (11,5 x 92 mm), Sarstedt® 6 ml tube with cap (11,5 x 92 mm), Sarstedt®
[20]	15119	7 ml probówka szklana (12 x 100 mm) 7 ml glass tube (12 x 100 mm)
[20]	15120	5 ml probówka szklana (12 x 75 mm) 5 ml glass tube (12 x 75 mm)
[20]	15419	5 ml probówka z korkiem (12 x 85 mm), Sarstedt® 5 ml tube with cap (12 x 85 mm), Sarstedt®

**14186**

[16]	*	BD Vacutainer® (13 x 75 mm), (1,6-5,3 ml)
[16]	*	BD Vacutainer® (13 x 100 mm), (4-7 ml)
[16]	*	Greiner Vacuette® (13 x 75 mm), (1-4,5 ml)
[16]	*	Greiner Vacuette® (13 x 100 mm), (3,5-6 ml)
[16]	*	Sarstedt S-Monovette® (11 x 66 mm), (1,6; 2; 2,7; 3; 3,1 ml)
[16]	*	Sarstedt S-Monovette® (13 x 65 mm), (2,6; 2,9; 3,4; 3,8 ml)
[16]	*	Sarstedt S-Monovette® (13 x 75 mm), (2,7; 3; 4,3 ml)
[16]	*	Sarstedt S-Monovette® (11 x 92 mm), (4,5; 5 ml)
[16]	*	Sarstedt S-Monovette® (13 x 90 mm), (4,9; 5,6 ml)
[16]	15054	6 ml probówka z pokrywką (11,5 x 92 mm), Sarstedt® 6 ml tube with cap (11,5 x 92 mm), Sarstedt®
[16]	15119	7 ml probówka szklana (12 x 100 mm) 7 ml glass tube (12 x 100 mm)
[16]	15120	5 ml probówka szklana (12 x 75 mm) 5 ml glass tube (12 x 75 mm)
[16]	15419	5 ml probówka z korkiem (12 x 85 mm), Sarstedt® 5 ml tube with cap (12 x 85 mm), Sarstedt®

**14187**

[16]	*	BD Vacutainer® (16 x 100 mm), (2,5-11 ml)
[16]	*	Greiner Vacuette® (16 x 100 mm), (7-9 ml)
[16]	*	Sarstedt S-Monovette® (15 x 92 mm), (7,5; 8,2; 8,5 ml)
[16]	*	Sarstedt S-Monovette® (15 x 75 mm), (4; 4,3; 5,5 ml)
[16]	15048	15 ml Thermo Nalgene® (16 x 113 mm) 15 ml Thermo Nalgene® (16 x 113 mm)
[16]	15053	10 ml probówka z pokrywką (16 x 106 mm) 10 ml tube with cap (16 x 106 mm)
[16]	15118	10 ml probówka szklana (16 x 100 mm) 10 ml glass tube (16 x 100 mm)
[16]	15046	14 ml probówka z pokrywką (16,8 x 113,7 mm), Sarstedt® 14 ml tube with cap (16,8 x 113,7 mm), Sarstedt®

**14584**

[16]	*	BD Vacutainer® CPT™ (16 x 125 mm), (8 ml)
------	---	---



## DECLARATION OF CONFORMITY

Product name: **Laboratory centrifuge MPW-352**

Product type: **Laboratory centrifuge**

This declaration of conformity is issued under the sole responsibility of the manufacturer.

Product classification on the basis of the Directive 98/79/EC: Non classified to list A or B and not for self-testing.

**Product complies with the requirements:**

• **Directive 98/79/EC (IVD), including the requirements of harmonized standards:**

EN 15223-1:2016

EN ISO 18113-3:2011

EN 13612:2002

EN 61326-2-6:2006

EN 13612:2002/AC:2002

EN 61010-2-101:2002

EN 13975:2003

EN 62304:2006

EN ISO 14971:2012

EN 62304:2006/AC:2008

EN ISO 18113-1:2011

EN 62366:2008

• **selected harmonized standards of Directive 2014/35/UE (LVD):**

EN 61010-1:2010

EN 61010-2-020:2006

• **directive 2014/30/UE (EMC).**

„MPW MED. INSTRUMENTS”  
SPÓŁDZIELNIA PRACY  
w Warszawie

„MPW MED. INSTRUMENTS”  
SPÓŁDZIELNIA PRACY

Warsaw, 46 Boremlowska Street  
applies Quality Management System in line with  
PN-EN ISO 9001:2015, PN-EN ISO 13485:2016

Certifying authority:

Członek Zarządu  
Wojciech Anisiewicz

PREZES ZARZĄDU  
*mgr Łukasz Satański*



## DECLARATION OF CONFORMITY

Product name: **Refrigerated laboratory centrifuge MPW-352R**

Product type: **Laboratory centrifuge**

This declaration of conformity is issued under the sole responsibility of the manufacturer.

Product classification on the basis of the Directive 98/79/EC: Non classified to list A or B and not for self-testing.

**Product complies with the requirements:**

• **Directive 98/79/EC (IVD), including the requirements of harmonized standards:**

EN 15223-1:2016

EN ISO 18113-3:2011

EN 13612:2002

EN 61326-2-6:2006

EN 13612:2002/AC:2002

EN 61010-2-101:2002

EN 13975:2003

EN 62304:2006

EN ISO 14971:2012

EN 62304:2006/AC:2008

EN ISO 18113-1:2011

EN 62366:2008

• **selected harmonized standards of Directive 2014/35/UE (LVD):**

EN 61010-1:2010

EN 61010-2-020:2006

• **directive 2014/30/UE (EMC).**

„MPW MED. INSTRUMENTS”  
SPÓŁDZIELNIA PRACY  
w Warszawie

„MPW MED. INSTRUMENTS”  
SPÓŁDZIELNIA PRACY

Warsaw, 46 Boremlowska Street

applies Quality Management System in line with  
PN-EN ISO 9001:2015, PN-EN ISO 13485:2016

Certifying authority:

Członek Zarządu  
Wojciech Anisiewicz

PREZES ZARZĄDU  
*[Signature]*  
mgr Łukasz Satański



## DECLARATION OF CONFORMITY

Product name: **Refrigerated and heated laboratory centrifuge  
MPW-352RH**

Product type: **Laboratory centrifuge**

This declaration of conformity is issued under the sole responsibility of the manufacturer.

Product classification on the basis of the Directive 98/79/EC: **Non classified to list A or B and not for self-testing.**

**Product complies with the requirements:**

• **Directive 98/79/EC (IVD), including the requirements of harmonized standards:**

EN 15223-1:2016

EN ISO 18113-3:2011

EN 13612:2002

EN 61326-2-6:2006

EN 13612:2002/AC:2002

EN 61010-2-101:2002

EN 13975:2003

EN 62304:2006

EN ISO 14971:2012

EN 62304:2006/AC:2008

EN ISO 18113-1:2011

EN 62366:2008

• **selected harmonized standards of Directive 2014/35/UE (LVD):**

EN 61010-1:2010

EN 61010-2-020:2006

• **directive 2014/30/UE (EMC).**

„MPW MED. INSTRUMENTS”  
SPÓŁDZIELNIA PRACY  
w Warszawie

„MPW MED. INSTRUMENTS”  
SPÓŁDZIELNIA PRACY  
Warsaw, 46 Boremlowska Street  
applies Quality Management System in line with  
PN-EN ISO 9001:2015, PN-EN ISO 13485:2016  
Certifying authority:

Członek Zarządu

Wojciech Anisiewicz

PREZES ZARZĄDU  
*mgr Łukasz Satański*



Warsaw, 2018. 09.15

no. 10.352RH.02.en



## DECLARATION OF CONFORMITY

(with RoHS 2 Directive 2011/65/EU)

## DEKLARACJA ZGODNOŚCI

(z dyrektywą RoHS 2 2011/65/UE)

### PRODUCT DETAILS/DANE PRODUKTU

**Product name/Nazwa produktu:**

Laboratory centrifuge MPW-352 /

Wirówka laboratoryjna MPW-352

**Product type/Typ:**

Laboratory centrifuge/Wirówka laboratoryjna

**Manufactured by/Wytworzona przez:**

"MPW MED. INSTRUMENTS"

SPÓŁDZIELNIA PRACY

ul. Boremlowska 46, 03-347 Warszawa, Polska

We hereby declare under our sole responsibility, that the product above is in compliance with the requirements of RoHS 2 Directive 2011/65/EU. /

Niniejszym deklarujemy z pełną odpowiedzialnością, że produkt, do którego odnosi się niniejsza deklaracja, jest zgodny z Dyrektywą RoHS 2 2011/65/UE.

"MPW MED. INSTRUMENTS"  
SPÓŁDZIELNIA PRACY  
w Warszawie

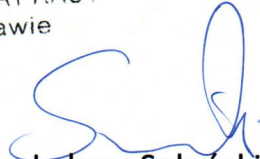
Warsaw/Warszawa, 2018.09.15

(place and date of issue/miejsce i data  
sporządzenia deklaracji)

  
Wojciech Anisiewicz

Member of Management  
Board/Członek Zarządu

(name and signature of authorized person/imię i nazwisko osoby  
upoważnionej do sporządzenia deklaracji)

  
Łukasz Sałański

President of Management  
Board/Prezes Zarządu



## DECLARATION OF CONFORMITY

(with RoHS 2 Directive 2011/65/EU)

## DEKLARACJA ZGODNOŚCI

(z dyrektywą RoHS 2 2011/65/UE)

### PRODUCT DETAILS/DANE PRODUKTU

**Product name/Nazwa produktu:**

Refrigerated laboratory centrifuge MPW-352R /

Wirówka laboratoryjna z chłodzeniem MPW-352R

**Product type/Typ:**

Laboratory centrifuge/Wirówka laboratoryjna

**Manufactured by/Wytworzona przez:**

„MPW MED. INSTRUMENTS”

SPÓŁDZIELNIA PRACY

ul. Boremlowska 46, 03-347 Warszawa, Polska

We hereby declare under our sole responsibility, that the product above is in compliance with the requirements of RoHS 2 Directive 2011/65/EU. /

Niniejszym deklarujemy z pełną odpowiedzialnością, że produkt, do którego odnosi się niniejsza deklaracja, jest zgodny z Dyrektywą RoHS 2 2011/65/UE.

„MPW MED. INSTRUMENTS”  
SPÓŁDZIELNIA PRACY  
w Warszawie

Warsaw/Warszawa, 2018.09.15

(place and date of issue/miejsce i data  
sporządzenia deklaracji)

  
Wojciech Anisiewicz

Member of Management  
Board/Członek Zarządu

(name and signature of authorized person/imię i nazwisko osoby  
upoważnionej do sporządzenia deklaracji)

  
Łukasz Szański

President of Management  
Board/Prezes Zarządu



## DECLARATION OF CONFORMITY

(with RoHS 2 Directive 2011/65/EU)

## DEKLARACJA ZGODNOŚCI

(z dyrektywą RoHS 2 2011/65/UE)

### PRODUCT DETAILS/DANE PRODUKTU

**Product name/Nazwa produktu:**

Refrigerated and heated laboratory centrifuge MPW-352RH /

Wirówka laboratoryjna z chłodzeniem i grzaniem MPW-352RH

**Product type/Typ:**

Laboratory centrifuge/Wirówka laboratoryjna

**Manufactured by/Wytworzona przez:**

„MPW MED. INSTRUMENTS”

SPÓŁDZIELNIA PRACY

ul. Boremlowska 46, 03-347 Warszawa, Polska

We hereby declare under our sole responsibility, that the product above is in compliance with the requirements of RoHS 2 Directive 2011/65/EU. /

Niniejszym deklarujemy z pełną odpowiedzialnością, że produkt, do którego odnosi się niniejsza deklaracja, jest zgodny z Dyrektywą RoHS 2 2011/65/UE.

Warsaw/Warszawa, 2018.09.15

(place and date of issue/miejsce i data  
sporządzenia deklaracji)

Wojciech Anisiewicz

Member of Management  
Board/Członek Zarządu

(name and signature of authorized person/imię i nazwisko osoby  
upoważnionej do sporządzenia deklaracji)

„MPW MED. INSTRUMENTS”  
SPÓŁDZIELNIA PRACY  
w Warszawie

Łukasz Szański

President of Management  
Board/Prezes Zarządu

# DECLARATION OF DECONTAMINATION

(repair)

In order to protect our employees please fill out the declaration of decontamination completely before sending centrifuge to the manufacturer (repair).

**1. Device:**

– type: .....

– serial No.: .....

**2. Description of decontamination**

(see user manual)

.....

.....

.....

.....

**3. Decontamination carried out by:**

name: .....

**4. Date and signature:**

.....

# DECLARATION OF DECONTAMINATION

(return)

In order to protect our employees please fill out the declaration of decontamination completely before sending centrifuge to the manufacturer (return).

**1. Device:**

– type: .....

– serial No.: .....

**2. Description of decontamination**

(see user manual)

.....  
.....  
.....  
.....

**3. Decontamination carried out by:**

name: .....

**4. Date and signature:**

.....



# NOMOGRAM

Centrifuging radius [cm]

R.C.F. (x "g")  
multiple of  
gravitational  
acceleration

[r.p.m.]

