

USER MANUAL



MPW-380 MPW-380R

Read before use!

Serial number of centrifuges:

For centrifuges with serial no (SN):

MPW-380 10380035223 – ...

MPW-380R 10380R034623 – ...



This manual was prepared with particular care. MPW MED. INSTRUMENTS may change the manual at any time and without notice because of improvements, typographical errors, or improvements to facilities
All rights reserved. No part of this User Manual may be modified, distributed, published, or reproduced without the prior permission of MPW MED. INSTRUMENTS.

You can find the current version of the user manual on our website under:









www.mpw.pl **DOWNLOAD** section (one should choose demanded language version of website).

Content

1. Symbols used in the manual and on the device	5
1.1 Markings on the device	5
2. Application	6
3. Technical specification	7
3.1 Environmental conditions	7
4. Installation	8
4.1 Content of the package	8
4.2 Location	8
4.3 Current protection	9
5. Safety notes	9
5.1 General remarks	9
5.2 Placing the rotor and accessories in the centrifuge	9
5.3 Filling tubes	10
5.4 Filling the rotor	10
5.4.1 <i>Angular rotors</i>	10
5.4.2 <i>Horizontal rotors</i>	11
5.5 Safety hints	12
5.6 Operating conditions	13
5.7 Equipment life	13
5.8 Work safety	13
5.9 Unbalance	14
5.10 Emergency stop	14
5.11 Residual risk	15
5.12 Obligation to report a serious device incident	15
6. Product description	15
6.1 Product Design and Appearance	15
6.2 Name plate	16
6.3 Control device	16
6.4 Setting parameters	16
6.5 Safety features	16
6.6 Increase in temperature (MPW-380 only)	17
7. Centrifuging	17
7.1 Control panel	17
7.2 Display	18
7.3 Setting up RPM, RCF, time, temperature	19
7.4 Users programs	21
7.5 Creator of acceleration and deceleration curves	22
7.5.1 <i>Acceleration characteristic, Creation of episode 1</i>	23
7.5.2 <i>Adding and editing sections - acceleration</i>	23
7.5.3 <i>Acceleration graph</i>	24
7.5.4 <i>Deceleration characteristic – creating section 1</i>	24
7.5.5 <i>Adding and editing sections - deceleration</i>	25
7.5.6 <i>Deceleration graph</i>	25
7.5.7 <i>Deleting sections</i>	26
7.6 Programs with user characteristics	26
7.7 Rotor choosing	26
7.8 SHORT mode	26
7.9 Finishing the centrifuging	27
7.10 Temporarily disabled functions	27
8. Temperature control	27
8.1 Initial cooling during centrifuging –FAST COOL	28



8.2	Initial cooling or heating without centrifuging – THERMAL CHAMBER	28
8.3	Cooling or heating in “START DELAY – OF TEMPERATURE” mode	29
8.4	Cooling or heating in „SHORT” mode	29
8.5	Cooling and heating notes	29
9.	Parameters of centrifugation	29
9.1	Acceleration/deceleration – changing characteristic	30
9.2	Radius	30
9.3	Sample density	30
9.4	Temperature offset	31
9.5	Thermal chamber	31
9.6	Automatic lid opening	32
9.7	Start delay - of time	32
9.8	Start delay – of temperature	33
9.9	Printing report (USB)	33
10.	Menu	37
10.1	Screen saver	37
10.2	Visual alarm	37
10.3	Types of main screen	38
10.3.1	Switching the normal display to simplified display	38
10.3.2	Switching the simplified screen to normal display	38
10.4	Rotating runtime	39
10.5	Buzzer	39
10.6	Language	39
10.7	Other	39
10.8	Password	40
10.9	Last 10 cycles	42
10.10	Work time	42
10.11	Rotor runtime	42
10.12	Contact us	42
10.13	Diagnostics	42
10.14	Factory settings	43
11.	Maintenance	43
11.1	Cleaning of the centrifuge	43
11.2	Maintenance of centrifuge elements	43
11.3	Sterilization	44
11.3.1	Autoclaving	45
11.4	Chemical resistance	46
12.	Troubleshooting	47
12.1	Messages	47
12.2	Emergency cover release	48
13.	Guarantee	49
14.	Transport and storage	49
15.	Disposal	50
16.	List of changes in the manual	50
17.	Manufacturer’s info	51
	Distributor’s info	51
18.	ANNEXES	51
A.	Additional accessories	
B.	Declaration of conformity (CE, ROHS 2)	
C.	Declaration of decontamination (repair / return)	
D.	Nomogram RPM / RCF	

1. Symbols used in the manual and on the device

Symbol	Explanation
	WARNING! Warning of potential injury or health risk
	DANGER! Risk of electric shock with potential for severe injury or death as a consequence
	DANGER! Biohazard with potential for risk to health or death as a consequence
	DANGER! Risk of explosion with potential for severe injury or death as a consequence
	Symbol identifying a medical device for in vitro diagnostic use
	CE mark
	Symbol informing about the method of disposal
	Please read the instruction manual before you start working with the device
	Manufacturer's data

1.1 Markings on the device

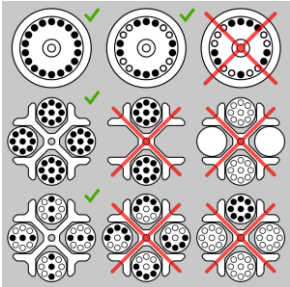
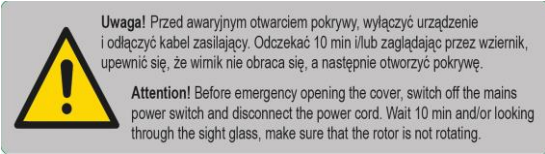
<i>Symbol</i>	<i>Explanation</i>	<i>Location</i>
	Information about the direction of rotation of the rotor	Under the centrifuge lid

	Reminder for proper rotor maintenance	Under the centrifuge lid
	Information about correct and incorrect filling of rotors	Under the centrifuge lid
	Information about the place of danger	On the side of the centrifuge next to the emergency opening of the lid
	Information reminding about the proper tightening of the rotor	Under the centrifuge lid

2. Application

- **MPW-380, 380R** centrifuges are a family of table-top non-automatic laboratory centrifuges (MPW-380 – ventilated centrifuge, MPW-380R – refrigerated centrifuge).
- The devices are intended for In Vitro Diagnostics (IVD). This means that it is an in vitro diagnostic medical device - in accordance with the Regulation of the European Parliament and of the Council (EU) of 5 April 2017 on in vitro diagnostic medical devices and repealing Directive 98/79/EC and Commission Decision 2010 /227/EU.
- Centrifuges are used to separate aqueous solutions and suspensions of samples with a density not higher than **1.2g/cm³** taken from human, animal and plant organisms into components of different densities under the influence of centrifugal force, in order to provide information about their biological state and to other analytical work.
- The design of the centrifuge ensures ease of use, safe operation and a wide range of applications in medical, biochemical, and other analysis laboratories.
- The centrifuge is not biotight, therefore, when centrifuging preparations that require biotightness, containers and rotors with a biotightness certificate should be used.

3. Technical specification

manufacturer	"MPW MED. INSTRUMENTS" SPÓŁDZIELNIA PRACY, Boremłowska 46 Street, 04-347 Warsaw									
type	MPW - 380					MPW – 380R				
cat. number (REF)	10380/2-56	10380/1-56/100	10380/1-56/110	10380/1-56	10380/1-56/127	10380R/2-56	10380R/1-6/100	10380R/1-6/110	10380R/1-6	10380R/1-6/127
mains voltage (L1+N+PE)	230V	100V	110V	120V	127V	230V	100V	110V	120V	127V
	±10%	±5%				±10%	±5%			
mains frequency,	50/60Hz					50/60Hz	60Hz			
power consumption (max.)	800W					1400W				
current protection [A]	10A	12A				18A	20A			
cooling medium	-					R452A				
capacity (max.)	3000 ml									
speed – RPM	90 ÷ 18000 RPM (step 1 RPM)									
force – RCF	31876 x g (step 1 x g)									
kinetic energy (max.)	45000 J									
running time	00:00:01 ÷ 99:59:59 – [hours, min., sec] (step 1s)									
time counting	since start button is pressed / since preselected speed is reached									
short-time operation mode – SHORT	yes									
continuous operation mode – HOLD	yes									
menu languages	POLISH, ENGLISH, GERMAN, SPANISH, ITALIAN, PORTUGUESE, RUSSIAN, SWEDISH, FRENCH, CZECH									
user programs	100									
adjustable temperature	-					-20 ÷ 40°C* (step 1°C)				
cooling / heating	no / no					yes / no				
guaranteed temperature with max. rotor speed	-					≤4°C				
cooling	no					yes				
cooling without centrifuging	no					yes				
acceleration (ACEL)	10 linear curves									
deceleration (DECEL)	10 linear curves									
programmable non-linear curves:										
acceleration						10				
deceleration						10				
USB communication	yes									
Electromagnetic compatibility	according to EN 61326-2-6:2006									
degree of protection (according to PN-EN 60034-5:2021-01)	IP21					IP21				
height (H)	455 mm					455 mm				
width (W)	515 mm					715 mm				
depth (D)	650 mm					650 mm				
height with open cover (H _{oc})	960 mm					960 mm				
noise level	<67 dB									
weight 230V	approx. 76 kg					approx. 114 kg				
weight 120V	approx. 81,5 kg					approx. 120 kg				

*time and possibility of obtaining a set temperature is dependent on multiple factors , including rotor type, established RPM, ambient temperature; accuracy: - ±1°C appropriate for place of temperature sensor

3.1 Environmental conditions

- The device may only be used indoors.
- The permissible ambient temperature is 2°C to 40°C.
- Maximum allowed relative humidity 80% at temperature up to 31°C decreasing linearly to 50% relative humidity at 40°C.
- The mains voltage fluctuations must not exceed ± 10% of the nominal voltage.
- Maximum altitude 2,000 m above sea level.
- Overvoltage category II.
- Pollution degree 2.



4. Installation

Open the package. Remove the box containing the accessories. Take out centrifuge from the container. Keep the box and packing materials in case of service shipping.

4.1 Content of the package

name	pcs.	cat no.
centrifuge MPW-380/R	1	10380/2-56; 10380/1-56; 10380/1-56/100; 10380/1-56/110; 10380/1-56/127 10380R/2-56; 10380R/1-6; 10380R/1-6/100; 10380R/1-6/110; 10380R/1-6/127 (type and supply version dependent)
rotor fixing screw	1	17798
rotor key / emergency opening of the cover	1	17799
power cord 230V / 120V	1	17009/17010
vaseline 20ml	1	17201
USB A-A cable	1	16655
user manual	1	See page 1

4.2 Location

	<ul style="list-style-type: none"> ▪ Ensure safe location. ▪ The centrifuge shall not be located near source of heat and shall not be subjected to direct sunlight. ▪ Centrifuge should be flat-levelled. Effect of levelling shall be ensured by stable and flat-levelled tabletop for the centrifuge. ▪ Centrifuge should be set horizontally on a rigid base. ▪ It is necessary to ensure a ventilation zone of the minimum 30cm round the centrifuge from every direction. Do not veil ventilation holes ! ▪ Table for centrifuge should possess safety zone of the minimum 30cm round the centrifuge from every direction (safety needs in case of malfunction according to EN 61010-020). ▪ Table for centrifuge should be free of containments before locating of centrifuge. ▪ Passed parameters of the centrifuge are referring to the above-named temperatures (see Technical specification). ▪ At the change of the place from cold to warm one, condensation of water will occur inside the centrifuge. It is important then that sufficient time be provided for drying the centrifuge prior to starting the centrifuge again (min. 4 hours). ▪ Do not position the centrifuge so that it is difficult to operate the power switch. ▪ Supply voltage given on the name plate has to be consistent with local supply voltage. MPW MED INSTRUMENTS laboratory centrifuges are 1st safety class devices, and they are provided with the three-core cable with the plug resistant to dynamic loadings. ▪ Mains sockets have to be provided with the safety pin (protective earth (PE)). ▪ It is recommended to install emergency cut-out that shall be located far from the centrifuge, near the exit or beyond the room.
	<p>Before switching on, check whether the centrifuge is connected to power supply correctly. It is obligatory to use only power cord recommended by manufacturer.</p>

4.3 Current protection



The centrifuge is equipped with thermal current protection. Fuse is situated in the power switch (without an additional fuse).

5. Safety notes

5.1 General remarks



- The laboratory centrifuge may be operated only by qualified laboratory personnel, after reading the operating manual.
- The operating instructions are part of the product.
- The operating manual should always be kept in the vicinity of the centrifuge.
- The centrifuge cannot be operated contrary to its purpose.
- If the centrifuge is used in a manner inconsistent with the manufacturer's guidelines, the safety of its use may be impaired.
- For centrifugation in the centrifuge, only containers and inserts provided in the list of equipment and centrifuge tubes, the diameter, length and strength of which are appropriate, should be used. The use of test tubes not included in the list should be agreed with MPW MED. INSTRUMENTS or its authorized representatives.
- Pay attention to the quality and appropriate thickness of the glass test tubes walls. Glass tubes should be centrifuge tubes, and their use in the centrifuge should be made dependent on the following guidelines:

glass tubes	max RCF in angular rotors	max RCF in horizontal rotors
5-10 ml	3000 x g	4000 x g
30-100 ml	spinning not allowed	4000 x g

- Weighing the filled test tubes into the rotor is recommended. When centrifuging in horizontal rotors, it is recommended to weigh the filled containers / hangers. This will allow to minimize the differences in mass between them, and as a result to avoid the negative impact of vibrations on the engine suspension and to reduce noise levels during the operation of the centrifuge.

5.2 Placing the rotor and accessories in the centrifuge



- Connect the centrifuge to the power supply (mains socket at the back of the centrifuge).
- Turn on the centrifuge (switch on the side of the centrifuge).
- Open the cover of the centrifuge by pressing the COVER key. Before installing the rotor, check that the rotating chamber is free from any contamination. If there is dust, glass splinters, liquid residues, etc., remove them.
- The rotor can fall if not handled properly, therefore it should always be handled and placed in the centrifuge using both hands.
- Place the rotor on the motor axis by sliding it onto the cone as far as it will go (keeping the coaxiality between the rotor and the motor axis).
- Screw the screw fixing the rotor into the motor axis (clockwise), and then tighten it firmly with the rotor key.
- Fill the rotor with containers / hangers / test tubes according to recommendations in section **Filling the rotor**.

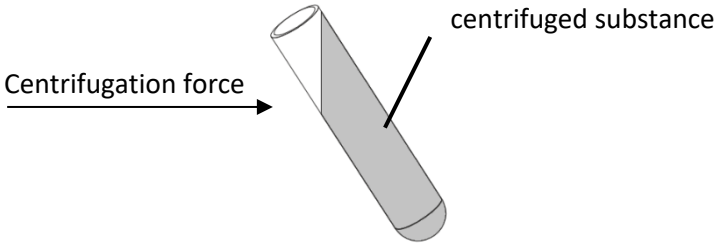
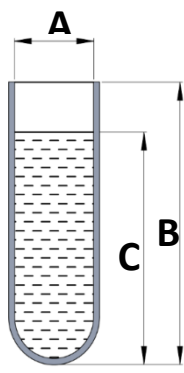

	<ul style="list-style-type: none"> ▪ In order to replace the rotor, first remove the tubes and containers from it, unscrew the screw fixing the rotor with the enclosed rotor key, counterclockwise, then using both hands, grab the rotor on opposite sides and remove it from the motor axis. ▪ Install another rotor as described above instructions.
--	--

5.3 Filling tubes

	<ul style="list-style-type: none"> ▪ Fill test tubes outside the centrifuge. <div style="text-align: center;">  </div> <ul style="list-style-type: none"> ▪ If the manufacturer of the test tube has not specified the maximum level, fill the test tubes so that the centrifuged substance does not run out of the vessel during centrifugation. To do this, use the formula below: <div style="text-align: center;">  </div> <div style="text-align: right; margin-right: 100px;"> $C < B - \frac{A}{2}$ <p> A – internal tube diameter B – tube height C – max liquid level </p> </div>
---	---

5.4 Filling the rotor

5.4.1 Angular rotors

	<p>CAUTION!</p> <ul style="list-style-type: none"> ▪ Angle rotors must be used with a suitable cover which must be screwed securely onto the rotor. The rotor and the cover are marked with the same catalog number (REF) to eliminate the risk of incorrect selection when you have several types of rotors.
	<ul style="list-style-type: none"> ▪ Check that the impeller is seated correctly and firmly bolted to the motor shaft. ▪ Do not exceed the maximum rotor load (information is provided on the rotor). <p style="text-align: center;">An example of the marking on the angular rotor:</p>

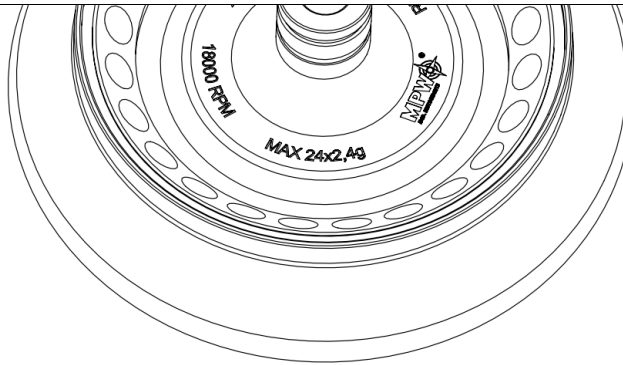

MAX. 24x2,4g - means the possibility of placing 24 test tubes in the rotor, each weighing 2.4 g.

- To ensure symmetrical loading, insert test tubes of the same type and weight in pairs into opposite openings of the rotor. If reduction inserts are used, they should also be placed in the holes opposite to each other in pairs of the same type.

Examples of correct and incorrect arrangement of test tubes in the rotor:

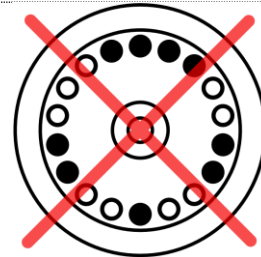
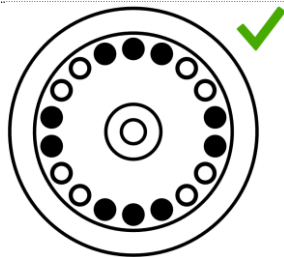
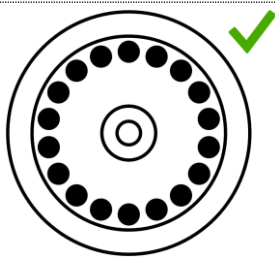

5.4.2 Horizontal rotors

- Check that the impeller is seated correctly and firmly bolted to the motor shaft.
- Make sure that the rotor pins and grooves of the containers / hangers are clean, and then it is necessary to lubricate them with the technical petroleum jelly supplied with the device (catalog number 17201).
- Place the containers / hangers in the rotor.
- Horizontal rotors must be filled with a set of containers / hangers.
- Observe the limitations for the permissible centrifugal mass stated on the rotor and container. If the marking appears on the rotor, it refers to the mass of the substance to be centrifuged, and if on the container it refers to the mass of the contents of the container, i.e. insert, test tube and the substance contained in it.

Examples of markings on horizontal rotors and containers:

Marking on the rotor

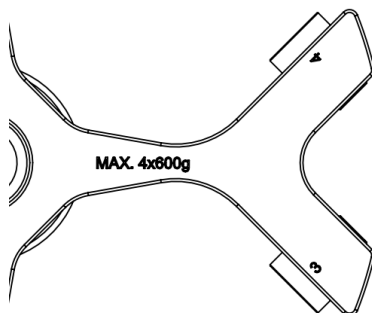

MAX. 4x600g – permissible weight of the contents of the test tubes placed in each of the 4 containers

Marking on the container





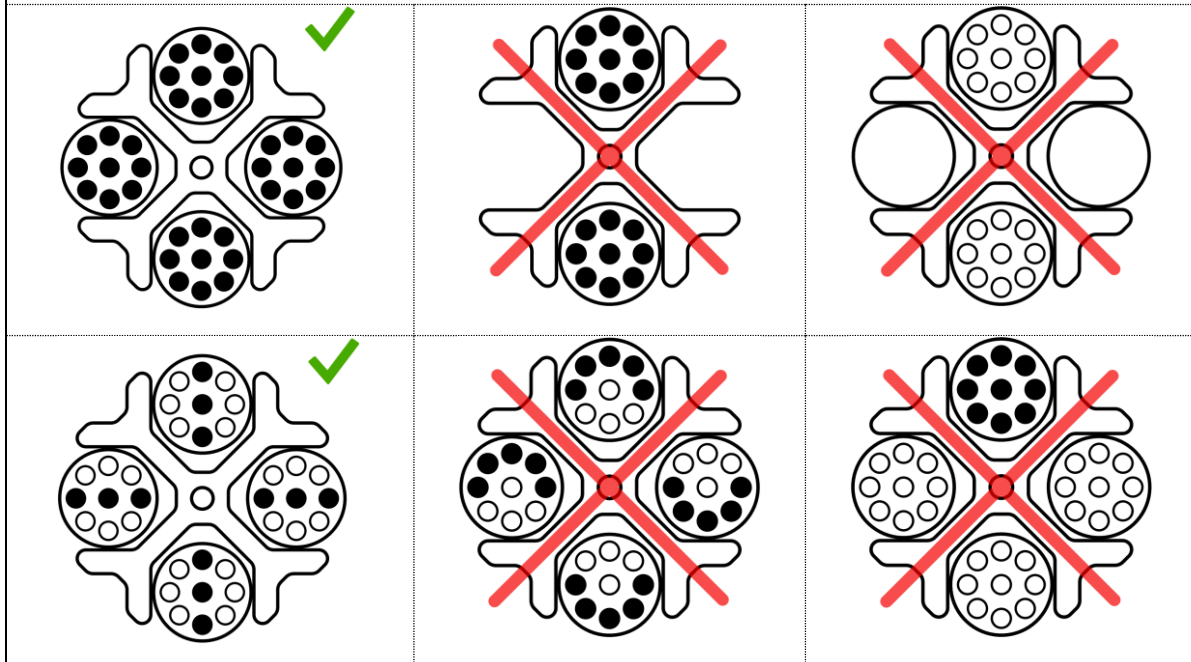

MAX. 290g – maximum weight of the contents of the container

- In order to ensure symmetrical and even rotor load, try to fill opposite seats with containers / hangers of the same type and weight.
- Tubes should be placed symmetrically facing each other.
- Before starting the centrifugation, check that all containers / hangers are properly placed in the rotor and can swing freely.
- For this purpose, empty test tubes should be placed in containers. Manually tilt the containers to the horizontal position and check that there are no collisions between the tubes, containers / hangers and the rotor.

Examples of correct and incorrect arrangement of test tubes in the rotor:





5.5 Safety hints

	<p>ROTOR MAINTENANCE</p> <ul style="list-style-type: none"> ▪ In order to increase the durability of gaskets, threaded places, rotor pins, undercuts for pins in containers, they must be cleaned, and then it is necessary to lubricate them with the technical petroleum jelly supplied with the device (catalog number 17201). ▪ Use only accessories that are in good technical condition.
	<p>HU EQUIPMENT MAINTENANCE</p> <ul style="list-style-type: none"> ▪ Make sure the sealing rings (rubber) are lightly coated with grease to maintain tightness. Use high vacuum silicone grease, eg type "C" by LUBRINA.
	<p>HAZARDOUS MATERIALS</p> <ul style="list-style-type: none"> ▪ Infectious materials should be centrifuged only in containers / rotors with covers. ▪ It is not allowed to centrifuge toxic or infectious materials if the rotor or test tube seal is damaged. ▪ Appropriate disinfection procedures should always be carried out, if hazardous substances have contaminated the centrifuge or its accessories.
	<p>EXPLOSIVE, FLAMMABLE MATERIALS</p> <ul style="list-style-type: none"> ▪ It is not allowed to centrifuge explosive and inflammable materials.

	<ul style="list-style-type: none"> ▪ Do not centrifuge substances that could create a potentially explosive atmosphere as a result of the high energy supply during centrifugation. ▪ The centrifuge must not be used in an explosive atmosphere. ▪ It is not allowed to centrifuge materials that may generate flammable or explosive mixtures when exposed to air.
--	---

5.6 Operating conditions

	<p>GENERAL REMARKS</p> <ul style="list-style-type: none"> ▪ Only original equipment of centrifuges and spare parts should be used. ▪ In case of a malfunction of the centrifuge, the MPW MED factory service should be used. INSTRUMENTS or its authorized representatives. ▪ It is not allowed to start the centrifuge if it is not installed correctly or the rotor and accessories are not properly mounted. ▪ The centrifuge must not be transported with the rotor installed on the motor shaft. ▪ Fill the rotor equipment to the same weight in order to prevent unbalance of the centrifuge (point Filling the rotor).
---	---

	<p>START-UP</p> <ul style="list-style-type: none"> ▪ Before switching on the device, carefully read all sections of this manual in order to ensure the correct operation of the device and to avoid damage to the device or its accessories.
---	--

	<p>CENTRIFUGAL SUBSTANCES</p> <ul style="list-style-type: none"> ▪ Rotors are designed for centrifuging liquids with an average density of 1.2 g / cm³ or less. This applies to centrifugation at maximum speed. If liquids with a higher density are to be used, be sure to enter the density value in the PARAM / DENSITY tab in order to reduce the available spin speed.
---	---

5.7 Equipment life



	<ul style="list-style-type: none"> ▪ Each spin cycle in which the rotor has accelerated and decelerated is considered a duty cycle, independent of speed and duration. ▪ Do not use the equipment after the allowable number of cycles or after the maximum service life has passed, whichever comes first (the service life is 15000 cycles or 5 years).
--	---

5.8 Work safety

The centrifuge should be inspected by an authorized service at least once a year (after the warranty period). Special circumstances, e.g., corrosive environment, may be the reason for more frequent checks. Tests should end with issuing a validation protocol, which specifies checking the technical condition of a laboratory centrifuge.

It is recommended to create a document that records all repairs and inspections. This document should be kept in the place where the centrifuge is used.

	<p>CONTROLS CONDUCTED BY THE OPERATOR</p> <ul style="list-style-type: none"> ▪ The operator must pay attention to the fact that the parts of the centrifuge, important from the safety point of view, are not damaged. This remark applies to:
---	--

	<ul style="list-style-type: none"> ▪ Centrifuge accessories, especially structural changes, corrosion, initial cracks, abrasion of metal parts. ▪ Bolted connections. ▪ Inspection of rotor and container seals, if any. Particular attention should be paid to rubber elements (seals). In the event of any damage or visible structural changes, they should be immediately replaced with new ones. ▪ Control of the performance of annual post-warranty inspections of the technical condition of the centrifuge.
	<ul style="list-style-type: none"> ▪ During centrifugation, it is not allowed to lift, shift the centrifuge or rest on it. ▪ During centrifugation one must not stay in the safety zone, i.e., 30 cm distance around the centrifuge, nor leave any objects, e.g., glass vessels, inside this zone. ▪ It is not allowed to put any objects on the centrifuge.
	<p>OPENING THE COVER DURING SPINNING</p> <ul style="list-style-type: none"> ▪ It is not allowed to use the emergency cover opening during centrifuging, because it may result in loss of health or life.
	<p>HANDLING OF ROTORS</p> <ul style="list-style-type: none"> ▪ It is not allowed to use accessories (rotors, lids, containers, hangers and round carriers) with signs of corrosion or other mechanical damage. ▪ It is not allowed to centrifuge substances of high corrosive aggressiveness, which may damage the materials and reduce the mechanical properties of rotors, buckets and round carriers. ▪ It is not allowed to centrifuge rotors with removed or loose covers.

5.9 Unbalance

	<p>Unbalance causes noise, vibration during operation and has a negative effect on the driveline (engine and suspension). The more precisely the process of balancing the feed to the rotor is carried out, the smoother the centrifuge will run and the longer the useful life of the drive system will be. Moreover, thanks to the correct balancing, an excellent level of separation of the centrifuged substance is achieved since the separated components will not be picked up again by vibrations.</p>
---	---

The centrifuge is equipped with a rotor imbalance sensor. In the event of its activation, the centrifugation process is stopped by quick braking and an error message is displayed. Erasing the error message is possible by pressing one of the following buttons: **BACK, STOP, COVER, SET** and **▲ ▼ ◀▶**.

Make sure that the rotor has been properly loaded - places in the rotor must be equipped with identically filled containers, inserts and test tubes so as to obtain the best possible weight balance (see chapter Filling the rotor). If necessary, correct the load distribution and / or, in the case of horizontal rotors, clean and lubricate the rotor pins, then restart the spin.

5.10 Emergency stop

At any time during centrifugation, it is possible to interrupt the process and stop the centrifugation with the fastest rotor characteristics. This is done by pressing the stop button twice (**2x STOP**).

Pressing the **STOP** key once will stop the spinning with the braking characteristics set in the program. The message about interrupted centrifuging can be canceled with the following buttons: **BACK, STOP, COVER, SET** and **▲ ▼ ◀▶**.

5.11 Residual risk

The centrifuge is built according to the state-of-the-art and the recognized safety regulations. Nevertheless, still remain some level of residual risk due to improper operation and malfunctions. It is possible to decrease residual risk by strictly applying user manual conditions and correcting malfunction which could threaten safety, immediately

5.12 Obligation to report a serious device incident

Any serious incident related to the device should be reported to the manufacturer and the competent authority of the Member State where the user or patient resides.

6. Product description

6.1 Product Design and Appearance

A new generation of MPW MED. INSTRUMENTS laboratory centrifuges is provided with state-of-the-art microprocessor control systems, durable and quiet asynchronous brushless motors, and accessories consistent with requirements of the present-day user.

The centrifuge has rigid self-supporting structure. Housing was made of sheet aluminum, back made of steel sheet. Front and cover were made of ABS type plastic. Cover is fixed on steel hinges and from the front it is locked with two electromagnetic locks blocking possibility of opening during centrifugation. Rotation chamber casing was made of thick steel sheet. The spin chamber is made of stainless-steel sheet.

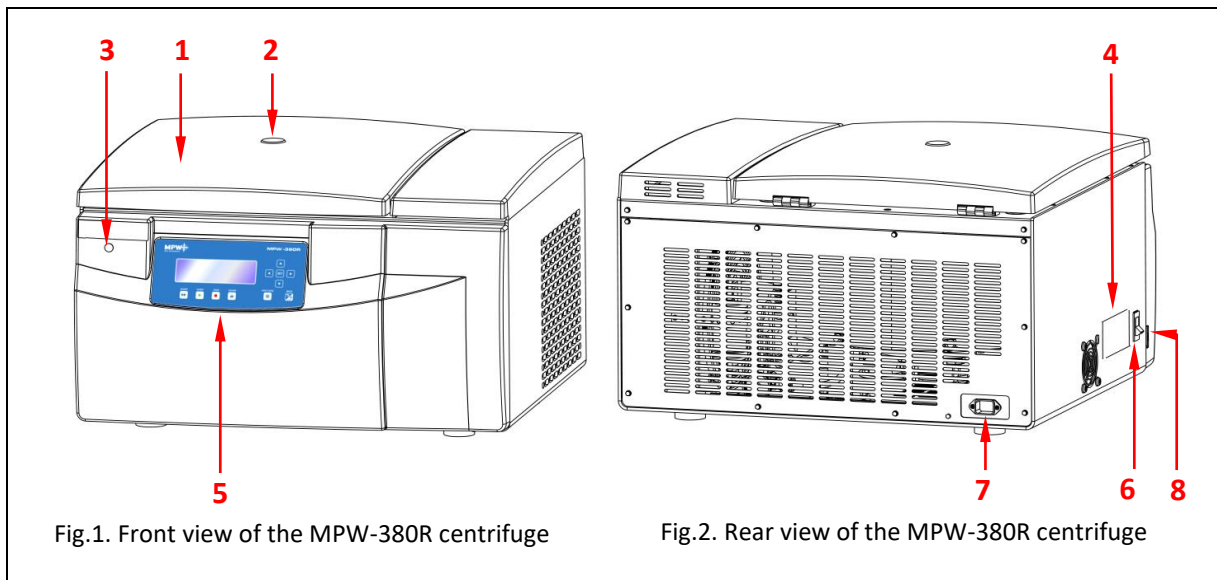

<p>1 Centrifuge lid</p> <p>2 Inspection glass (is used to control the rest condition of the rotor)</p> <p>3 Emergency cover release</p> <p>4 Name plate</p> <p>5 Control panel (display and control of the centrifuge)</p>	<p>6 Main's switch</p> <p>7 Centrifuge power socket</p> <p>8 USB port (sending a report to a computer for saving or printing work results)</p>
---	---

6.2 Name plate

The data concerning the device should be read from the rating plate located on the rear wall of the centrifuge (the picture below is an example).

1	Model	MPW-380R	9	Rated frequency	50-60 Hz
2	REF	10380R/256	10	Current protection	18 A
3	n	18000 rpm	11	Manufacturer's logo	MPW MED. INSTRUMENTS
4	AC	230 V	12	Manufacturer's information	"MPW MED. INSTRUMENTS" SPÓŁDZIELNIA PRACY ul. Boremłowska 46, 04-347 Warszawa, POLAND
5	P	1400 W	13	Information about the refrigerant (refrigerated centrifuges only)	R452A / 0,6 kg / 1,29 t eq CO ₂ / GWP 2141 / 27 bar fluorinated greenhouse gas / hermetically sealed refrigeration system
6	Kinetic energy	45000 J	14	Density of centrifuged substance	Max. density 1,2 g/ml
7	SN	10380R000123	15	QR code for serial number	[QR Code]
8	Approval marks and symbols (explained in chapter 1)	CE IVD i ⚠	16	Date of production	2023-06-14

6.3 Control device

The microprocessor control unit of the centrifuge ensures broad possibilities of providing, realization and reading of work parameters.

6.4 Setting parameters

Data setting and read-out system forms hermetically closed keyboard with distinctly accessible operation points. Easily readable displays signalling individual performed operations facilitate operator's programming and recording of parameters and condition of the centrifuge.

The centrifuge is provided with the USB interface that enables connection of the centrifuge to external PC unit with the printer and recording the centrifugation parameters.

6.5 Safety features

Cover lock

The centrifuge can be started only with properly closed cover. While the cover can be opened only after stopping the rotor. In case of emergency opening of the cover during operation, the centrifuge drive will be immediately switched-off and the rotor will brake till complete stopping.



Unbalance detecting

When loads of opposite buckets or carriers in rotors are unbalanced, the drive will be switched-off during acceleration or operation of the centrifuge – and the error message will be displayed.

Rotor verification and checking compatibility with loaded program

Directly after starting centrifuging, a unit verifies the type of the rotor applied and in the case of its incompatibility with the type indicated in the application or absence of the rotor, the spinning process shall be stopped with simultaneous displaying the error message. The conformity of the type of the rotor is signalled with a single audible signal. In case autoidentification (see 9.8 Other) option is checked, proper rotor will be automatically chosen, without user engagement.

Rest state inspection

Opening the centrifuge lid with the **COVER** key is possible only when the rotor is at rest. Check that the symbol  described in the **Display** chapter is visible on the screen. Use the sight glass on the cover to make sure the impeller is not turning. When the rotor brakes, the symbol  described in the **Display** section is visible. Emergency opening of the cover during rotor spinning is not allowed.

Checking of excessive temperature

If temperature in rotation chamber exceeds 50°C (MPW-380R) caused by, for example, malfunction of cooling system, drive will be switched off and error message will be displayed. The reboot is only possible after chilling device.

6.6 Increase in temperature (MPW-380 only)

In uncooled centrifuges, the temperature in the rotor chamber, rotor and sample can increase to above 40°C, based on the run time, g-force (rcf)/speed and ambient temperature.









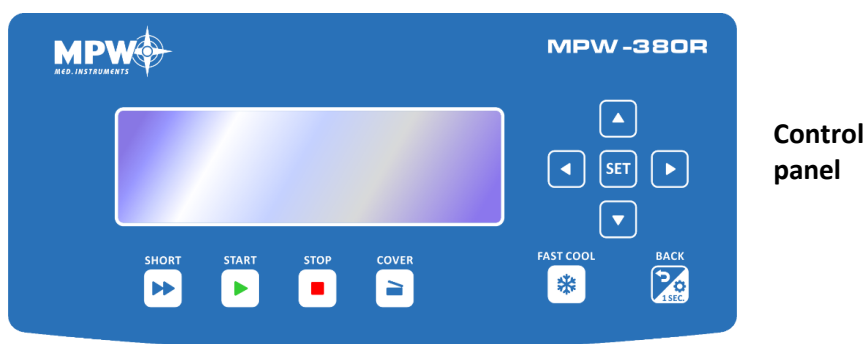

7. Centrifuging

Power switching ON/OFF is carried out with master switch situated on the left side wall of the centrifuge. All settings on the centrifuge are done by means of the control panel.

7.1 Control panel

The control panel placed on the front casing serves the purpose of controlling centrifuge operation.





	SHORT ¹	short-time centrifuging
	START	start centrifugation run
	STOP ²	end centrifugation run
	COVER	cover opening
	FAST COOL	start fast cooling mode (MPW-380R only)
	BACK/ OPTIONS	exit the current menu / enter to submenu of options (keep held down within 1 s.)
	UP	navigation in menu / increasing values
	DOWN	navigation in menu / decreasing values
	LEFT	navigation in menu
	RIGHT	navigation in menu
SET	SET	changing parameters / confirming changes

¹ the centrifuge is working as long as the key is pressed















² first-time pressing press – will make stopping centrifuging with acceleration characteristics set in the current program, second-time pressing – will make the centrifuging as fast as possible (quickest characteristic). During setting of the parameters, it serves for exiting zones on the primary screen without introducing changes.

7.2 Display

The display is located in the centre of the control panel. The main screen variants are presented below. In the user manual exemplary screens from MPW-380R are shown. For MPW-380 (without refrigeration) temperature is not shown. Blinking of field on display mean it is ready to set. Blinking of field is visualised as highlighted in the user manual.

	<p>After switching on centrifuge, welcome screen appears. After disappearing the welcome screen, it is possible to setting up parameters.</p>
	<p>Simplified display mode is set as default, there is possible to switch to normal.</p>
	<p>Normal display contains an expanded number of settings visible during operation.</p>
<p>Detailed information on display modes is provided in chapter <i>Types of main screen</i>.</p>	

SPEED	rotor speed	assigned/measured
RCF	relative centrifugal force	assigned/measured
TIME	centrifuging time	assigned/measured
TEMP	temperature	assigned/measured
PRG	program no.	
11199	rotor no.	
PARAM	parameters of the centrifuge	
MENU	configuration menu	

	changing values		
	user multi sections curve		
	density > 1,2 g/cm ³		
	centrifuging radius changed		
	counting time down (decreasing)		counting time up (increasing)
	cooling to assigned temperature		
	FAST COOL mode cooling		
	centrifuging		centrifuging (with automatic cover opening)
	rotor stopped / closed cover		rotor stopped / opened lid
	braking		fastest decelerating
	rotor identification		

	thermal chamber		
	temperature delay		
	time delay		
	drop-down list		
	temporarily disabled		
	locked		
	time counting (blinking)		
	disabled option		active option

7.3 Setting up RPM, RCF, time, temperature

On the main screen, it is possible to set:

rotating speed - RPM	SPEED
relative centrifugal force (multiple of g-force)	RCF
centrifuging time	TIME
centrifuging temperature	TEMP



Exemplary change of **SPEED** setting:

	<ul style="list-style-type: none"> ▪ Press SET (to enter edit mode) – appears. ▪ Via ▲▼◀▶ keys mark SPEED field (blinking). ▪ Press SET- blinking. ▪ Via ◀▶ choose order of magnitude of changing value (blinking). ▪ With ▲▼ choose demanded value. ▪ Repeat above two steps for other orders of magnitude. ▪ Confirm settings by pressing SET. ▪ Press BACK.
<ul style="list-style-type: none"> ▪ When RPM is changed, RCF is automatically corrected. 	



Exemplary change of **RCF** setting:

	<ul style="list-style-type: none"> ▪ Press SET (to enter edit mode) – appears. ▪ Via ▲▼◀▶ keys mark RCF field (blinking). ▪ Press SET- blinking. ▪ Via ◀▶ choose order of magnitude of changing value (blinking). ▪ With ▲▼ choose demanded value.
--	--

	<ul style="list-style-type: none"> Repeat above two steps for other orders of magnitude. Confirm settings by pressing SET. Press BACK.
<ul style="list-style-type: none"> When RCF is changed, RPM is automatically corrected. 	

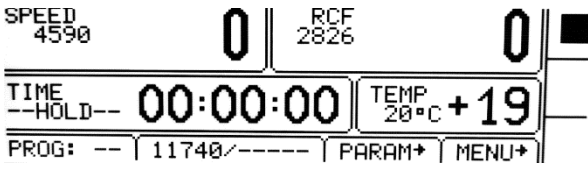
Exemplary change of TIME setting:	
	<ul style="list-style-type: none"> Press SET (to enter edit mode) -  appears. Via ▲▼◀▶ keys mark TIME field (blinking).
<p style="text-align: center;">00:02:00 [hh : mm : ss]</p> <p>e.g.: centrifuging time – 2 minutes 00 seconds</p>	<ul style="list-style-type: none"> Press SET  blinking. Via ◀▶ choose order of magnitude of changing value (blinking). With ▲▼ choose demanded value. Repeat above two steps for other orders of magnitude. Confirm settings by pressing SET. Exit edit mode by pressing BACK.
00:02:00	set value
02:00	current value (most significant digits)

HOLD mode	continuous run mode
	<ul style="list-style-type: none"> To run centrifuging in HOLD mode set 00:00:00 time. To end centrifuging in HOLD mode press STOP.

Exemplary change of TEMP setting:	
	<ul style="list-style-type: none"> Press SET (to enter edit mode) –  appears. Via ▲▼◀▶ keys mark TEMP field (blinking). Press SET key. With ▲▼ choose demanded value [-20°C÷40°C]. Confirm settings by pressing SET. Press BACK.

7.4 Users programs

	<p>After switching centrifuge on, program that was used in previous session is being loaded. If any program was not used in previous session, centrifuge resume the last chosen parameters.</p>
--	---

Program choosing:

Entering the program selection mode for the **simplified display**:

	<ul style="list-style-type: none"> Press and hold by 1 second. Choose PROG with ▲▼ Press SET.
--	---

Entering the program selection mode for the **normal display**:

	<ul style="list-style-type: none"> Press SET key – appears. Via ▲▼◀▶ keys mark PRG-- field (highlighted) Press SET key – list of programs is visible.
--	--

Program selection mode tab:

<table border="1"> <thead> <tr> <th>No</th> <th>SPEED</th> <th>RCF</th> <th>TIME</th> <th>TEMP</th> <th>ACC</th> <th>DEC</th> <th>ROT</th> </tr> </thead> <tbody> <tr> <td>0</td> <td>4590</td> <td>2826</td> <td>HOLD</td> <td>20</td> <td>0</td> <td>0</td> <td>11740</td> </tr> <tr> <td>1</td> <td>4590</td> <td>2826</td> <td>00:01:00</td> <td>20</td> <td>0</td> <td>0</td> <td>11740</td> </tr> <tr> <td>▶ 2</td> <td>5090</td> <td>3476</td> <td>00:02:00</td> <td>20</td> <td>0</td> <td>0</td> <td>11740</td> </tr> <tr> <td>3</td> <td></td> <td></td> <td></td> <td></td> <td></td> <td></td> <td></td> </tr> <tr> <td>4</td> <td></td> <td></td> <td></td> <td></td> <td></td> <td></td> <td></td> </tr> <tr> <td>5</td> <td></td> <td></td> <td></td> <td></td> <td></td> <td></td> <td></td> </tr> </tbody> </table>	No	SPEED	RCF	TIME	TEMP	ACC	DEC	ROT	0	4590	2826	HOLD	20	0	0	11740	1	4590	2826	00:01:00	20	0	0	11740	▶ 2	5090	3476	00:02:00	20	0	0	11740	3								4								5								<ul style="list-style-type: none"> Via ▲▼ choose demanded program. Confirm with SET key.
No	SPEED	RCF	TIME	TEMP	ACC	DEC	ROT																																																		
0	4590	2826	HOLD	20	0	0	11740																																																		
1	4590	2826	00:01:00	20	0	0	11740																																																		
▶ 2	5090	3476	00:02:00	20	0	0	11740																																																		
3																																																									
4																																																									
5																																																									

<table border="1"> <thead> <tr> <th>No</th> <th>SPEED</th> <th>LOAD</th> <th>SAVE</th> <th>DELETE</th> <th>CURVES</th> <th>NEW PROGRAM</th> <th>C</th> <th>DEC</th> <th>ROT</th> </tr> </thead> <tbody> <tr> <td>0</td> <td>4590</td> <td></td> <td></td> <td></td> <td></td> <td></td> <td>0</td> <td>0</td> <td>11740</td> </tr> <tr> <td>1</td> <td>4590</td> <td></td> <td></td> <td></td> <td></td> <td></td> <td>0</td> <td>0</td> <td>11740</td> </tr> <tr> <td>▶ 2</td> <td>5090</td> <td></td> <td></td> <td></td> <td></td> <td></td> <td>0</td> <td>0</td> <td>11740</td> </tr> <tr> <td>3</td> <td></td> <td></td> <td></td> <td></td> <td></td> <td></td> <td></td> <td></td> <td></td> </tr> <tr> <td>4</td> <td></td> <td></td> <td></td> <td></td> <td></td> <td></td> <td></td> <td></td> <td></td> </tr> <tr> <td>5</td> <td></td> <td></td> <td></td> <td></td> <td></td> <td></td> <td></td> <td></td> <td></td> </tr> </tbody> </table>	No	SPEED	LOAD	SAVE	DELETE	CURVES	NEW PROGRAM	C	DEC	ROT	0	4590						0	0	11740	1	4590						0	0	11740	▶ 2	5090						0	0	11740	3										4										5										<p>LOAD, SAVE, DELETE, NEW PROGRAM refers chosen program which is marked by ▶.</p> <p>▶ - program currently selected</p>
No	SPEED	LOAD	SAVE	DELETE	CURVES	NEW PROGRAM	C	DEC	ROT																																																														
0	4590						0	0	11740																																																														
1	4590						0	0	11740																																																														
▶ 2	5090						0	0	11740																																																														
3																																																																							
4																																																																							
5																																																																							

<table border="1"> <thead> <tr> <th>No</th> <th>SPEED</th> <th>SAVE ?</th> <th>C</th> <th>DEC</th> <th>ROT</th> </tr> </thead> <tbody> <tr> <td>0</td> <td>4590</td> <td></td> <td>0</td> <td>0</td> <td>11740</td> </tr> <tr> <td>1</td> <td>4590</td> <td></td> <td>0</td> <td>0</td> <td>11740</td> </tr> <tr> <td>▶ 2</td> <td>5090</td> <td>YES</td> <td>0</td> <td>0</td> <td>11740</td> </tr> <tr> <td>3</td> <td></td> <td>NO</td> <td></td> <td></td> <td></td> </tr> <tr> <td>4</td> <td></td> <td></td> <td></td> <td></td> <td></td> </tr> <tr> <td>5</td> <td></td> <td></td> <td></td> <td></td> <td></td> </tr> </tbody> </table>	No	SPEED	SAVE ?	C	DEC	ROT	0	4590		0	0	11740	1	4590		0	0	11740	▶ 2	5090	YES	0	0	11740	3		NO				4						5						<p>LOAD - loading the selected program</p> <p>SAVE – save settings as a program (confirm by selecting YES and pressing SET)</p>
No	SPEED	SAVE ?	C	DEC	ROT																																						
0	4590		0	0	11740																																						
1	4590		0	0	11740																																						
▶ 2	5090	YES	0	0	11740																																						
3		NO																																									
4																																											
5																																											

<table border="1"> <thead> <tr> <th>No</th> <th>SPEED</th> <th>DELETE ?</th> <th>C</th> <th>DEC</th> <th>ROT</th> </tr> </thead> <tbody> <tr> <td>0</td> <td>4590</td> <td></td> <td>0</td> <td>0</td> <td>11740</td> </tr> <tr> <td>1</td> <td>4590</td> <td></td> <td>0</td> <td>0</td> <td>11740</td> </tr> <tr> <td>▶ 2</td> <td>5090</td> <td>YES</td> <td>0</td> <td>0</td> <td>11740</td> </tr> <tr> <td>3</td> <td></td> <td>NO</td> <td></td> <td></td> <td></td> </tr> <tr> <td>4</td> <td></td> <td></td> <td></td> <td></td> <td></td> </tr> <tr> <td>5</td> <td></td> <td></td> <td></td> <td></td> <td></td> </tr> </tbody> </table>	No	SPEED	DELETE ?	C	DEC	ROT	0	4590		0	0	11740	1	4590		0	0	11740	▶ 2	5090	YES	0	0	11740	3		NO				4						5						<p>DELETE – delete program (confirm by selecting YES and pressing SET)</p>
No	SPEED	DELETE ?	C	DEC	ROT																																						
0	4590		0	0	11740																																						
1	4590		0	0	11740																																						
▶ 2	5090	YES	0	0	11740																																						
3		NO																																									
4																																											
5																																											

<table border="1"> <thead> <tr> <th>No</th> <th>SPEED</th> <th>LOAD</th> <th>SAVE</th> <th>DELETE</th> <th>CURVES</th> <th>NEW PROGRAM</th> <th>C</th> <th>DEC</th> <th>ROT</th> </tr> </thead> <tbody> <tr> <td>0</td> <td>4590</td> <td></td> <td></td> <td></td> <td></td> <td></td> <td>0</td> <td>0</td> <td>11740</td> </tr> <tr> <td>1</td> <td>4590</td> <td></td> <td></td> <td></td> <td></td> <td></td> <td>0</td> <td>0</td> <td>11740</td> </tr> <tr> <td>▶ 2</td> <td>5090</td> <td></td> <td></td> <td></td> <td></td> <td></td> <td>0</td> <td>0</td> <td>11740</td> </tr> <tr> <td>3</td> <td></td> <td></td> <td></td> <td></td> <td></td> <td></td> <td></td> <td></td> <td></td> </tr> <tr> <td>4</td> <td></td> <td></td> <td></td> <td></td> <td></td> <td></td> <td></td> <td></td> <td></td> </tr> <tr> <td>5</td> <td></td> <td></td> <td></td> <td></td> <td></td> <td></td> <td></td> <td></td> <td></td> </tr> </tbody> </table>	No	SPEED	LOAD	SAVE	DELETE	CURVES	NEW PROGRAM	C	DEC	ROT	0	4590						0	0	11740	1	4590						0	0	11740	▶ 2	5090						0	0	11740	3										4										5										<p>NEW PROGRAM– enter to create new program mode (as below)</p>
No	SPEED	LOAD	SAVE	DELETE	CURVES	NEW PROGRAM	C	DEC	ROT																																																														
0	4590						0	0	11740																																																														
1	4590						0	0	11740																																																														
▶ 2	5090						0	0	11740																																																														
3																																																																							
4																																																																							
5																																																																							

Creating a new program:

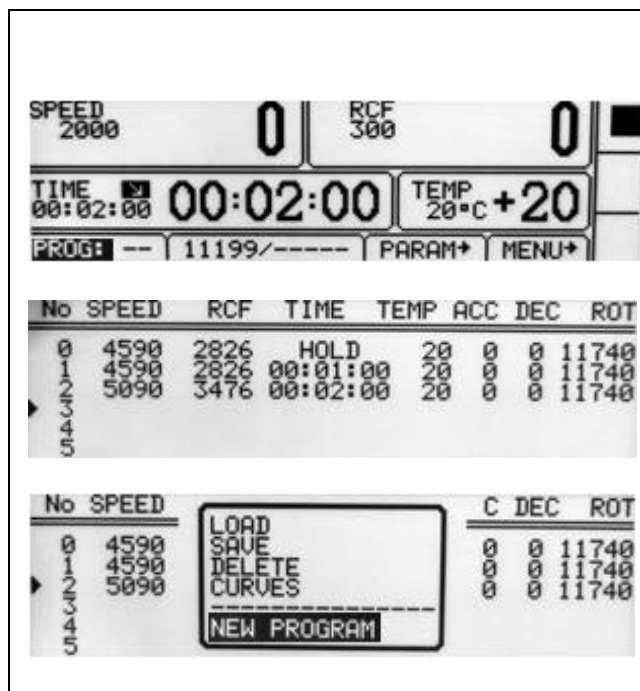

- Press **SET** key.
- Via ▲▼◀▶ keys mark **PROG** field (blinking).
- Press **SET** key. List of programs is visible, choose demanded position (number of program).
- Press **SET** key- menu of program settings will appear.
- Choose **NEW PROGRAM** press **SET** and **BACK**, and then set demanded parameters of centrifuging (look chapter **Centrifuging**).
- In case you want to register new program, back to the **PROG** menu and save it as described before.

Changing parameters during centrifuging

There is a possibility to change parameters: **SPEED, RCF, TIME, TEMP** during centrifuging. Such modifications inactivate currently running program. When program was set, modification during run is represented by **PROG --** symbol (instead of the program number).

7.5 Creator of acceleration and deceleration curves

	PROG/CURVES
	<ul style="list-style-type: none"> ▪ With ▲▼ keys choose saved program for which you intend to create the acceleration or deceleration characteristics (marked with symbol ▶). ▪ Press SET.
	<ul style="list-style-type: none"> ▪ With ▲▼ keys choose CURVES. ▪ Press SET - the selection frame is displayed.
	<ul style="list-style-type: none"> ▪ With ▲▼ keys choose ACCELERATION to create acceleration characteristics or DECELERATION to create deceleration characteristics ▪ Confirm selection by pressing SET.

7.5.1 Acceleration characteristic, Creation of episode 1

	No	section no. (max. 4)
	TIME	total acceleration time
	SPEED	final RPM
	ACC	characteristic's no. (10-19)
		adding a new section
		deleting last section
		editing sections
		exiting from characteristics wizard
		switching RPM/RCF

After entering the curve wizard, the symbol is highlighted. Pressing **SET** and selecting "NO" in response to the question "SAVE?" will return to the **PROG → CURVES** menu without making changes to the starting characteristics. To start editing the one-segment characteristics, select the icon with the **◀▶** keys and press the **SET** key.

		editing value (flashing means editing the given value)
	<ul style="list-style-type: none"> ▪ Press SET ▪ With ▲▼◀▶ choose time for section ▪ Press SET ▪ It is not possible to edit the maximum speed value. To do this, more sections have to be created, but the last section will always have the maximum set speed and cannot be changed. ▪ Select with ▼◀ buttons and press SET to finish editing characteristics. 	

7.5.2 Adding and editing sections - acceleration

To program next sections, select the icon with the **◀▶** buttons and press **SET**. A new section (sections) will appear with a time of 1 second and a speed equal to the maximum speed.

To start editing a newly added section (sections), select the icon with the **◀▶** buttons and press **SET**, and follow the instructions given below.

After entering the profile section editing menu, the time value of the first section will be highlighted (see the picture below).

	<p>The maximum speed value for the section cannot be higher than the maximum speed value for the characteristic (for the last section).</p>
	<ul style="list-style-type: none"> ▪ With ▲▼◀▶ highlight time or speed for desired section

	<ul style="list-style-type: none"> ▪ Press SET ▪ With ▲▼◀▶ choose value ▪ Press SET ▪ Repeat until setting all the sections ▪ To finish editing characteristic with ▲▼◀▶ choose ↻ and press SET. Finishing edition can be also done by pressing BACK button
--	--

Saving created characteristic	
	<ul style="list-style-type: none"> ▪ Select the ↻ icon with the ◀▶ buttons and press SET ▪ In the "Save?" window, use ▲▼ buttons to select YES to confirm saving the characteristic or NO, to exit without saving ▪ Press SET

7.5.3 Acceleration graph

<i>An example of given parameters and a graph:</i>	
	<p>After programming the time and / or speed values, the segment (all segments) is graphically displayed on the graph on the right side of the screen. The time value is on the horizontal axis of the user's starting characteristic, while the speed is on the vertical axis.</p>

7.5.4 Deceleration characteristic – creating section 1

<p>SPEED or 4000 displayed (example):</p>	NO	section no. (max. 4)
	TIME	total acceleration time
	SPEED	final RPM
	DEC	characteristic's no. (10-19)
	+	adding a new section
	-	deleting last section
	✎	editing sections
	↻	exiting from characteristics menu
↻	switching RPM/RCF	

After entering the curve wizard, the symbol ↻ is highlighted. Pressing **SET** and selecting "NO" in response to the question "SAVE?" will return to the **PROG → CURVES** menu without making changes to the starting characteristics. To start editing the one-segment characteristics, select the icon ✎ with the ◀▶ keys and press the **SET** key.

	<div style="border: 1px solid black; padding: 5px; margin-bottom: 10px;"> editing value (flashing means editing the given value) </div> <ul style="list-style-type: none"> ▪ Press SET ▪ With ▲▼◀▶ choose time for section ▪ Press SET ▪ To edit speed ▪ It is not possible to edit the minimum speed value. To do this, more legends must be created, but the last leg will always be "0". ▪ Select ↻ with ▼◀ buttons and press SET to finish editing characteristics
--	--

7.5.5 Adding and editing sections - deceleration

In order to program successive periods, select the icon ⊕ with the ◀▶ keys and press the **SET** key. A new segment (or segments - after successive presses of SET) will appear with the time and speed equal to the minimum speed - "0".

To start editing the newly added sections, select the icon ✎ with the ◀▶ buttons, press **SET** and make the settings as described below.

After entering the profile section editing menu, the time value of the first section will be highlighted (see the picture below).

	<p>The speed value of the last segment will always be "0"</p> <ul style="list-style-type: none"> ▪ With ▲▼◀▶ highlight time or speed for desired section ▪ Press SET ▪ With ▲▼◀▶ choose value ▪ Press SET ▪ Repeat until setting all the sections ▪ To finish editing characteristic with ▲▼◀▶ choose ↻ and press SET. Finishing edition can be also done by pressing BACK button
--	---

Saving created characteristic

	<ul style="list-style-type: none"> ▪ Select the ↻ icon with the ◀▶ buttons and press SET ▪ In the "Save?" window, use ▲▼ buttons to select YES to confirm saving the characteristic or NO, to exit without saving ▪ Press SET
--	--

7.5.6 Deceleration graph

An example of given parameters and a graph:

	<p>After programming the time and / or speed values, the segment (all segments) is graphically displayed on the graph on the right side of the screen. The time value is on the horizontal axis of the user's braking characteristic, while the speed is on the vertical axis.</p>
--	--

7.5.7 Deleting sections

In the characteristic's wizard:

No	TIME
1	0:00:11
2	0:00:01
3	0:00:01

- Select the icon with the buttons and press **SET**
- In the "Delete?" window, use buttons to select YES to confirm deleting the characteristic section or NO to cancel
- Press **SET**

7.6 Programs with user characteristics

Loading a modified program in the **CURVES** fold is signaled by the icon on the main screen:

Icon signals that program with user acceleration/deceleration characteristics are loaded.

A change in any parameter entails the deactivation of the multi-section's curves mode.

7.7 Rotor choosing

Simplified display mode

- Press and hold by 1 second.
- Choose rotor number (exemplary **11199/-----**) with .
- Press **SET**.
- Execute points described follow (below **Normal display mode** description)

Normal display mode

NO	ROTOR	BUCKET	SPEED	RCF	RMAX	RMIN
1	11199	-----	18000	24270	67	35
2	11210	-----	5000	3997	143	60
3	11211	-----	5500	4498	133	87
4	11213	-----	5500	4227	125	79
5	11259	-----	15000	24400	97	65
6	11273	-----	12000	14006	87	54

- Press **SET** appears.
- Via mark rotor choosing field.
- Press **SET** (Rotor list will appear).
- Via keys mark demanded rotor number
- Confirm by press **SET**.
- Press **BACK**.

It is possible to set **AUTOMATIC ROTOR IDENTIFICATION**.
The procedure is described in subsection **Others**.

7.8 SHORT mode

- The **SHORT** mode is activated by pressing and holding (**SHORT**).

In **SHORT** mode the centrifuge is working as long as the **SHORT** key is pressed or when set time is over.

7.9 Finishing the centrifuging

	When preselected time is reached, centrifugation will end automatically.
	<ul style="list-style-type: none"> Before lapse preselected time one may stop centrifugation. Pressing STOP for the first time will stop centrifuging with the characteristic set in loaded program. ↓ symbol will be shown.
	<ul style="list-style-type: none"> Pressing STOP second time will stop centrifuging with the fastest characteristic. ↓ symbol will be shown.
	<ul style="list-style-type: none"> The message about cancel of centrifuging can be delete with the STOP, SET, COVER, ▲▼◀▶ or BACK key.

7.10 Temporarily disabled functions

Functions written below can be temporarily disabled.

	SPEED	RCF	TIME	TEMP	PROG —	— / —	PARAM	MENU
THERMAL CHAMBER	●	●	●	○	●	●	●	●
STANDARD CENTRIFUGING	●	●	●	●	●	○	●	○

- available
- disabled

8. Temperature control

	MPW-380R only
--	---------------

Centrifuge is equipped with ecological refrigerating system with temperature control. During centrifugation, there may appear differences in temperature on the display and temperature of the samples in the rotor. It depends on thermal conductivity of the rotor, and samples and centrifugation time, initial temperature of rotor and samples.

Exemplary change of **TEMP** setting:

	<ul style="list-style-type: none"> Press SET (to enter edit mode) – appears. Via ▲▼◀▶ keys mark TEMP field (blinking). Press SET key. With ▲▼ choose demanded value (from -20°C to 40°C). Confirm settings by pressing SET. Press BACK.
--	---

	<p>Cooling is indicated by a symbol (blinking).</p>
--	--

8.1 Initial cooling during centrifuging –FAST COOL

	<p>The parameters allowable to change at FAST COOL mode:</p> <ul style="list-style-type: none"> temperature (lower than current temperature shown by centrifuge) <ul style="list-style-type: none"> In order to centrifuging reduced temperature samples (e.g. storage in the external refrigerator) centrifuge chamber, rotor and centrifuge container must be pre-cooling to the predetermined temperature. It causes minimalization of temperature differences. Initial cooling may be activated by FAST COOL key (lid must be closed – rotor is spinning at FAST COOL mode) When FAST COOL mode is active, cooling system automatically set proper parameters to obtain demanded temperature the fastest way.
--	---

	<p>FAST COOL mode is marked by symbol blinking in the right upper side of display.</p>
	<p>It is possible to exit FAST COOL mode at any time by pressing STOP key. Interruption of the function is signaled by a message.</p>

8.2 Initial cooling or heating without centrifuging – THERMAL CHAMBER

	<p style="text-align: right;">PARAM → THERMAL CHAMBER</p> <ul style="list-style-type: none"> There is possible to run centrifuge in THERMAL CHAMBER mode - cooling for R (rotor is at standstill). How to enable THERMAL CHAMBER is described in Parameters of centrifugation chapter.
--	---

8.3 Cooling or heating in “START DELAY – OF TEMPERATURE” mode

	PARAM → START DELAY – OF TEMPERATURE
	<ul style="list-style-type: none"> Centrifuging process will start, when preselected temperature is reached. How to enable run START DELAY – OF TEMPERATURE function is described in Parameters of centrifugation chapter.



8.4 Cooling or heating in „SHORT” mode

	<ul style="list-style-type: none"> Cooling and heating features are available in SHORT mode. How to enable run centrifugation in SHORT mode is described in <i>Centrifugation/SHORT mode</i>.
---	--

8.5 Cooling and heating notes

Centrifuges with cooling (MPW-380R) are equipped with an efficient cooling system. It allows obtaining selected temperatures in the chamber even at maximum spin speed or fast obtaining desired temperatures (e.g., 4°C and 36°C). Note that time and possibility of obtaining a set temperature is dependent on multiple factors, including: the power of the cooling system, the shape of the rotor, the rotor speed, ambient temperature, etc. The accuracy of the temperature stability of $\pm 1^\circ\text{C}$ is determined by the installation place of the temperature sensor.

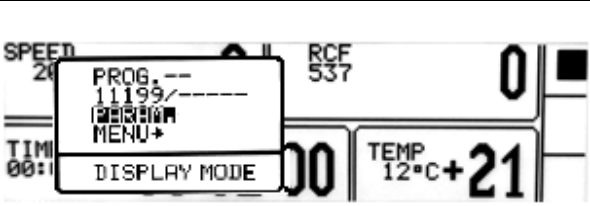
9. Parameters of centrifugation

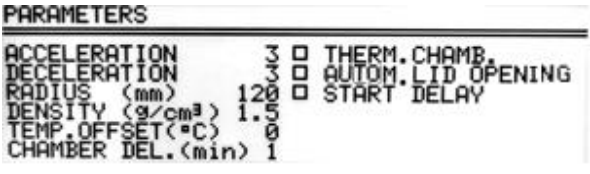
Simplified display	
	<ul style="list-style-type: none"> Press and hold  by 1 second. Choose PARAM. with ▲▼ Press SET. <p>Execute points described follow (below Normal display mode description)</p>
Normal display	
	<ul style="list-style-type: none"> Press SET. With ▲▼◀▶ keys select PARAM. Press SET.
	

ACCELERATION	chosen acc. characteristic (0-the fastest, 9-the slowest)
DECELERATION	chosen dec. characteristic (0-the fastest, 9-the slowest)
RADIUS [mm]	current rotor radius [mm]
DENSITY (g/cm³)	sample density [g/cm ³]
TEMP. OFFSET (°C)	value of temperature correction
CHAMBER DEL. (min)	delay between set thermal chamber mode and start it
THERMAL CHAMBER	cooling of the chamber without centrifuging
AUTOM. LID OPENING	opening cover after centrifuging automatically
START DELAY	starting delayed (after pressing START)

9.1 Acceleration/deceleration – changing characteristic.

<pre> PARAMETERS ----- ACCELERATION 3 <input type="checkbox"/> THERM.CHAMB. DECELERATION 3 <input type="checkbox"/> AUTOM.LID OPENING RADIUS (mm) 120 <input type="checkbox"/> START DELAY DENSITY (g/cm³) 1.5 TEMP.OFFSET(°C) 0 CHAMBER DEL.(min) 1 </pre>	<ul style="list-style-type: none"> With ▲▼ keys select ACCELERATION or DECELERATION. Press SET. With ▲▼ keys select demanded number of characteristics. Press SET. <p>ACCELERATION –10 (0 ÷ 9), linear accelerating characteristics assigned to every rotor. 0-the fastest acceleration, 9-the slowest acceleration.</p> <p>DECELERATION – 10 (0 ÷ 9), linear decelerating characteristics assigned to every rotor. 0-the fastest deceleration, 9-the slowest deceleration.</p>
---	---



9.2 Radius

<pre> PARAMETERS ----- ACCELERATION 3 <input type="checkbox"/> THERM.CHAMB. DECELERATION 3 <input type="checkbox"/> AUTOM.LID OPENING RADIUS (mm) 120 <input type="checkbox"/> START DELAY DENSITY (g/cm³) 1.5 TEMP.OFFSET(°C) 0 CHAMBER DEL.(min) 1 </pre>	<p>RADIUS [mm] - control of the radius of the rotor within the range from R_{min} to R_{max}. Available values depends on chosen rotor. Radius correction serve for more precise control RCF, exemplary when user need to know real RCF in half length of test tube.</p> <p>To change the rotor radius:</p> <ul style="list-style-type: none"> select RADIUS [mm] with ▲▼ keys. Press SET. Set demanded value by pressing ▲▼. Press SET.
	<p>When radius correction is activated, R symbol is visible on the screen.</p> <p>Reducing of the rotor radius resulting change of displayed RCF value.</p>

9.3 Sample density

<pre> PARAMETERS ----- ACCELERATION 3 <input type="checkbox"/> THERM.CHAMB. DECELERATION 3 <input type="checkbox"/> AUTOM.LID OPENING RADIUS (mm) 120 <input type="checkbox"/> START DELAY DENSITY (g/cm³) 1.5 TEMP.OFFSET(°C) 0 CHAMBER DEL.(min) 1 </pre>	<p>DENSITY (g/cm³) – default density is set to 1,2 g/cm³</p> <p>To change the density (possible values 1,2÷9,9 g/cm³):</p> <ul style="list-style-type: none"> Via ▲▼ keys select DENSITY (g/cm³) Press SET. Set demanded value by pressing ▲▼. Press SET.
	<p>When density is changed, D symbol is visible on the screen.</p> <p>Changing of DENSITY value is obligatory when density of sample placed into rotor is higher than 1.2 g/cm³.</p> <p>Change of DENSITY value led to decreasing maximum value of accessible speed.</p>

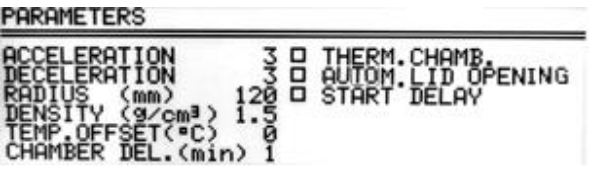
9.4 Temperature offset

	MPW-352R only
	<p>Temperature offset serve for more precise control of real sample temperature. It can be helpful in case high/low initial temperature samples or high volume samples.</p> <ul style="list-style-type: none"> With ▲ ▼ keys select TEMP. OFFSET. Press SET. Use the ▲ ▼ keys to select the difference between the temperature that the cooling system will aim for, and set temperature. Confirm selection by pressing SET. <p>Attention! The use of the offset can not extend the temperature range achieved by the centrifuge.</p> <p>Function description At a set temperature of 20°C and the set offset value equal to -5°C, cooling system will actually strive to reach 15°C. With a setpoint temperature of 20°C and a set offset value of 5°C the system will actually try to reach 25°C.</p> <p>The temperature displayed on the main screen is corrected for offset value.</p> <p>Offset can be selected range from -20°C to 20°C.</p>
	<p>Activation of the function is signaled on the main screen with  or  depending on the offset value sign.</p>

9.5 Thermal chamber

	MPW-380R only
---	----------------------

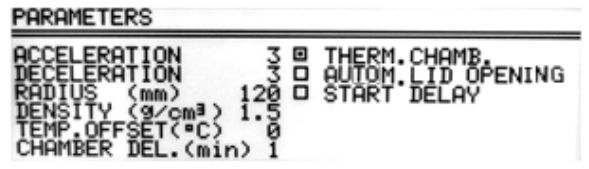
Cooling without centrifuging.	THERMAL CHAMBER
	<ul style="list-style-type: none"> With ▲ ▼ ◀ ▶ keys select THERMAL CHAMBER. Press SET (to turn on/off). With ▲ ▼ keys select temperature value. Set demanded value (0°C÷40°C) by pressing ▲ ▼. Confirm selection by pressing SET. Attention, do not set the thermal chamber to a value higher than currently indicated by the centrifuge.

	<ul style="list-style-type: none"> When THERMAL CHAMBER function is activated, T symbol is visible on the screen. Changing temperature from the main screen is not possible. Opening cover terminates THERMAL CHAMBER function (closing cover back turns it on).
	<p>Thermal chamber is activated with delay. Set time of delaying by select CHAMBER DEL.</p> <ul style="list-style-type: none"> Press SET. With ▲▼ keys select demanded value (1-5 min). Press SET.
<ul style="list-style-type: none"> The function is activated automatically after confirmation and with the lid closed. When the lid is opened, the function is interrupted, and when the lid is closed again, the function resumes. If the THERMAL CHAMBER function is enabled during the centrifugation cycle, at the end of this cycle, the THERMAL CHAMBER function is activated until the lid is opened. Contrary to other parameters, the THERMAL CHAMBER function can be turned on only when the centrifuge is stopped. 	

9.6 Automatic lid opening

<p>Automatic lid opening</p>	<p style="text-align: center;">AUTOMATIC LID OPENING</p>
	<ul style="list-style-type: none"> When centrifuge process is finished, cover will be opened automatically for set option AUTOM. LID OPENING. When centrifuging is terminated by pressing STOP, opening cover is possible by pressing COVER.
	<ul style="list-style-type: none"> symbol means that OPEN LID AFTER RUN is active.

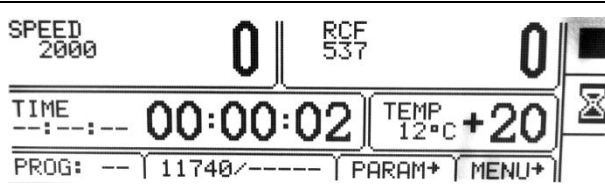

9.7 Start delay - of time

	<p>Start centrifuging since reselected delay is reached.</p>	<p style="text-align: center;">STARY DELAY / OF TIME</p>
		<ul style="list-style-type: none"> With ▲▼ keys select START DELAY. Press SET. Start delay can be set from 0 : 0 0 : 0 1 to 9 : 5 9. With ▲▼ keys select OF TIME. Press SET and ▶ and then SET. With ▲▼ keys set demanded value. Confirm by pressing SET. Press BACK to escape edit mode.

	When START DELAY function is activated, symbol is visible on the screen.
START DELAY / OF TIME function cannot be run when START DELAY / OF TEMP is activated.	

9.8 Start delay – of temperature

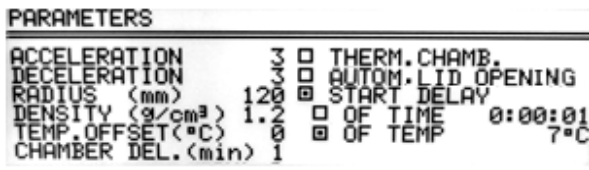
	MPW-380R only
---	----------------------

	Start centrifuging time counting since preselected temperature is reached.	START DELAY / OF TEMP.
	<ul style="list-style-type: none"> ▪ With ▲▼◀▶ keys mark START DELAY. ▪ Press SET. ▪ With ▲▼◀▶ keys mark OF TEMP. ▪ Press SET. ▪ Press ▶, press SET. ▪ With ▲▼ keys set demanded value of temperature. ▪ Press SET. ▪ Exit edit mode by press BACK. 	
	When START DELAY – OF TEMPERATURE is turned on,  symbol is visible on the screen.	
When the function is active, the speed can be reduced to the optimum values for the FAST COOL function, when the set speed is lower than the optimum value, the rotor rotates at the set by user speed.		
START DELAY / OF TEMP. function cannot be run when START DELAY / OF TIME is activated.		

9.9 Printing report (USB)

When the centrifuging process is finished there is a possibility to obtain report. Report can be transferred to PC or printed.

PC (USB)

The elements needed to make connecting your computer via USB:

name	quantity (pcs.)	cat. No.
USB A-A cable	1	16655
MPW Editor 2 application	1	to downloaded from the website: www.mpw.pl

Operating System Requirements: **Microsoft Windows 10 (64bit)**.

The Manufacturer does not guarantee that the program will work correctly with other operating systems.

Preparation

- Download installation file from website at **www.mpw.pl**.
- Unzip the file and run **setup.exe**.
- Install **MPW Editor 2** application on the computer, press **Install**.

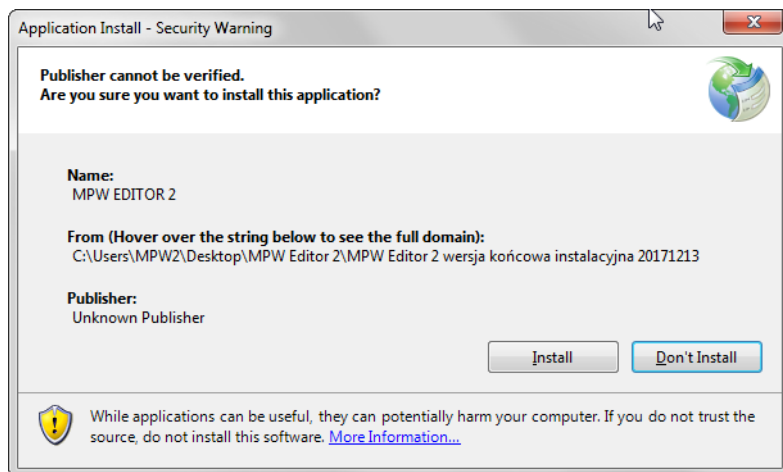

- If necessary install **FTDI USB drivers** and **.NET Framework 4.0** library (download with manufacturer's website: www.mpw.pl).

Centrifuging and printing

- Run **MPW Editor 2** application.
- Choose **Język\English**

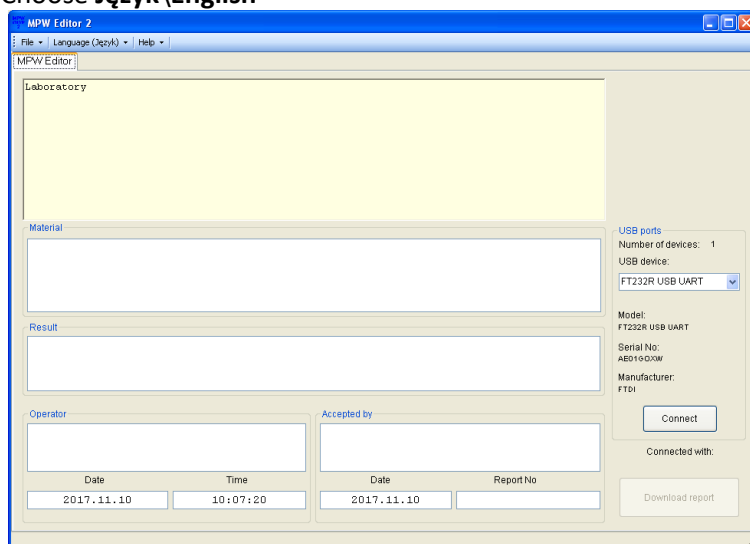

- Connect centrifuge to the PC in accordance with the „Connection scheme”
- Choose port assigned to the centrifuge (it will appear after connecting USB cable).

Attention:

If the interface has not been programmed: name, serial number and manufacturer's name, the device will be identified by Windows and MPW Editor 2 with the data programmed by FTDI (manufacturer USB integrated circuit) for example FT232R USB UART.

- Choose **File\Edit form**

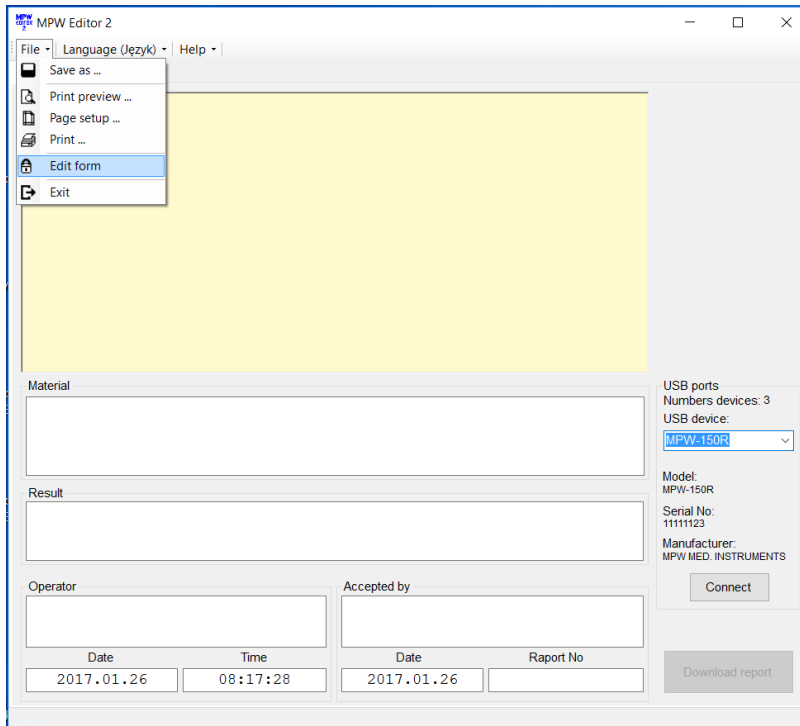

- In the „Tytuł (Title)” field, you can place any text, for example name of the laboratory, for later use in the report template.

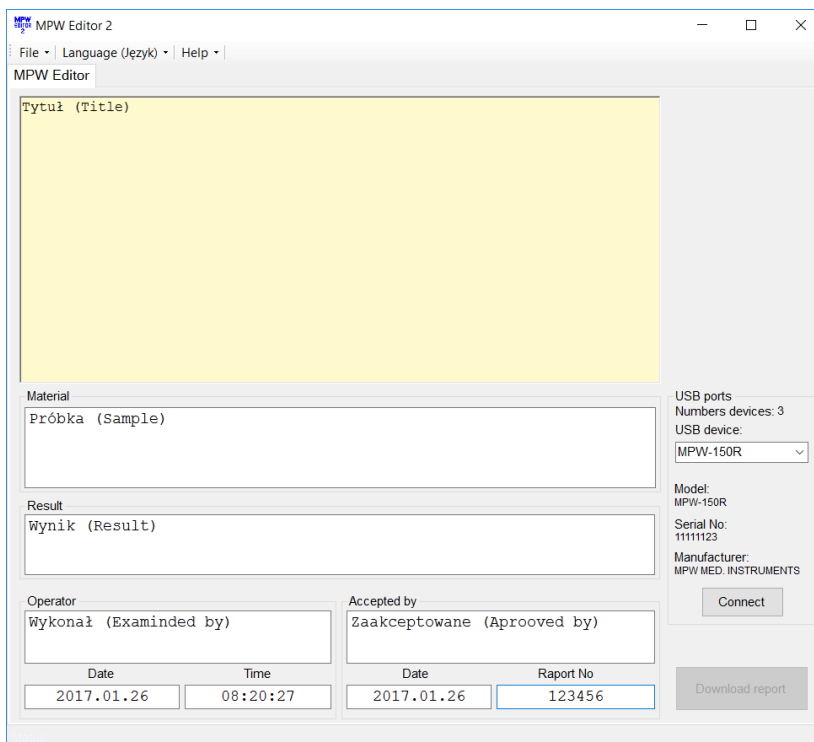

- Choose **File\Save form**.
- Ensure that USB device is selected from the list of devices.
- Press **Connect**. After successful communication, "PC" appears in the display.

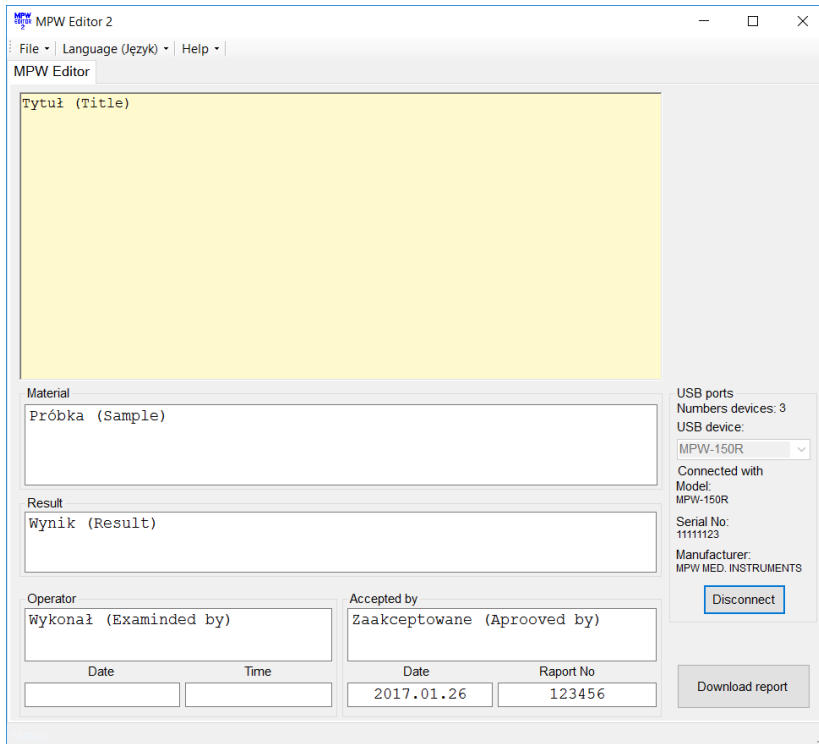

- Fill folds: „Material”, „Result”, „Operator”, „Accepted by”, „Raport no” (optionally).
- When the centrifuging process is finished, press **Download the report**.
- When centrifuging process is completed, report will appear.
- Save report (**File/Save as**) or print it (**File/Print**).
- In order to get another report, press New test and press Download the report.
- After finishing the work, press **Disconnect** button (the "PC" disappears from the display of the centrifuge) and then closes MPW Editor 2.

Connection diagram

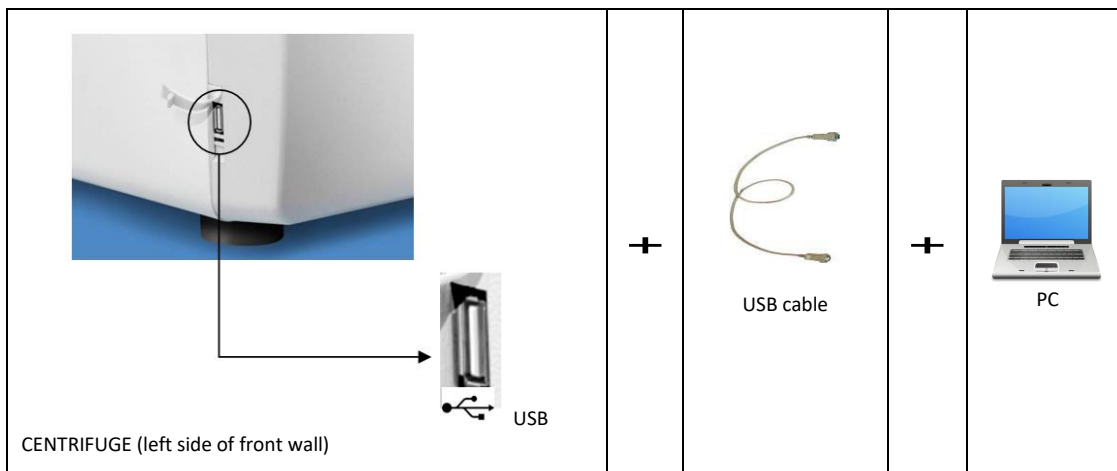

10. Menu

Simplified display									
	<ul style="list-style-type: none"> Press and hold by 1 second. Choose MENU with ▲▼ Press SET. <p>Execute points described follow (below Normal display mode description)</p>								
Normal display									
	<ul style="list-style-type: none"> Press SET. With ▲▼◀▶ keys select MENU. Press SET. 								
<p style="text-align: center;">MENU</p> <hr/> <table style="width: 100%; border: none;"> <tr> <td style="width: 50%;">CONFIGURATION</td> <td style="width: 50%;">ROTOR RUNTIME</td> </tr> <tr> <td>PASSWORD</td> <td>CONTACT US</td> </tr> <tr> <td>LAST 10 CYCLES</td> <td>DIAGNOSTICS</td> </tr> <tr> <td>WORK TIME</td> <td>FACTORY SETTINGS</td> </tr> </table>	CONFIGURATION	ROTOR RUNTIME	PASSWORD	CONTACT US	LAST 10 CYCLES	DIAGNOSTICS	WORK TIME	FACTORY SETTINGS	<ul style="list-style-type: none"> To navigate in MENU use ▲▼◀▶ keys. To enter menu press SET.
CONFIGURATION	ROTOR RUNTIME								
PASSWORD	CONTACT US								
LAST 10 CYCLES	DIAGNOSTICS								
WORK TIME	FACTORY SETTINGS								

CONFIGURATION	centrifuge configuration
PASSWORD	password protection
LAST 10-CYCLES	10 last centrifugation cycles history
CYCLES	total working time of centrifuge, total number of working cycles counter
ROTOR RUNTIME	counting time of work and cycles amount for each rotor
CONTACT US	manufacturer's details
DIAGNOSTICS	error codes (service field)
FACTORY SETTINGS	restore factory settings

10.1 Screen saver

Setting time of screen saver	MENU/ CONFIGURATION / SCREEN
	<ul style="list-style-type: none"> With ▲▼◀▶ keys select SCREENSAVER. Press SET and then ▼ and SET. With ▲▼ keys select demanded value from 1 to 60 minutes. Mark selection by pressing SET. Leave the menu by pressing BACK.

10.2 Visual alarm

Visual alarm	MENU/CONFIGURATION/ SCREEN
	<ul style="list-style-type: none"> Via ▲▼ keys choose VISUAL ALARM Mark it by pressing SET. <p>VISUAL ALARM cause blinking screen after ending of centrifuging or after message occurring.</p>

10.3 Types of main screen

To ensure optimal adaptation to the user's preferences, work is possible in two basic screen modes.

NORMAL DISPLAY - contains an expanded number of parameters visible on the display.

SIMPLIFIED DISPLAY - contains only the most important parameters visible on the display.

For each of the above modes, you can choose priority RPM display or RCF.

By default, the **SIMPLIFIED DISPLAY** is set

Types of main screen	
NORMAL DISPLAY	SIMPLIFIED DISPLAY
Switch between the SPEED (RPM) and RCF display priority modes	
<ul style="list-style-type: none"> In the NORMAL DISPLAY mode, selecting the SPEED or RCF display mode is obtained by pressing and holding BACK for 1 sec. then use the ▲ ▼ buttons to select the desired mode (SPEED or RCF) and press SET. 	<ul style="list-style-type: none"> In the SIMPLIFIED DISPLAY mode, the selection of the SPEED or RCF display mode is obtained by pressing and holding the BACK key for 1 second. then use ▲ ▼ keys to select DISPLAY MODE, press SET, and then use ▲ ▼ keys to select the desired mode (SPEED or RCF) and press SET.

10.3.1 Switching the normal display to simplified display

	Press the BACK button for 1 sec. then:
	<ul style="list-style-type: none"> Via ▲ ▼ keys select SIMPLIFIED DISPLAY. Press SET.

10.3.2 Switching the simplified screen to normal display

	<ul style="list-style-type: none"> Press the BACK button for 1 sec. then:
	<ul style="list-style-type: none"> Via ▲ ▼ keys select DISPLAY MODE (blinking). Press SET. Then choose NORMAL DISPLAY and press SET.

10.4 Rotating runtime

Way of time counting	MENU/CONFIGURATION/ ROTATING RUNTIME
<pre> ROTATING RUNTIME <=> 2/5 ----- <input checked="" type="checkbox"/> COUNTING FROM PRESSING START <input type="checkbox"/> COUNTING FROM REACHING SPEED <input checked="" type="checkbox"/> DESCENDING <input type="checkbox"/> ASCENDING </pre>	<ul style="list-style-type: none"> Via ▲▼ choose demanded option. Mark it by pressing SET.
Counting from: Pressing start → COUNTING SINCE ROTOR IS IDENTIFIED Reaching speed → COUNTING FROM ASSIGNED SPEED	
Presenting mode: Descending → COUNTING DOWN Ascending → COUNTING UP	

10.5 Buzzer

Switching ON/OFF short audible signals accompanying every pressing of any key. Switching ON/OFF signals after centrifuging.	MENU/ CONFIGURATION / BUZZER
<pre> BUZZER <=> 3/5 ----- <input type="checkbox"/> KEY TONE <input type="checkbox"/> CONTINUOUS ALARM </pre>	<ul style="list-style-type: none"> With ▲▼ keys select demanded option. Mark selection by pressing SET. <p>A continuous alarm means the emission of short beeps after the end of the spin, until the message about the end of the work cycle is deleted.</p>
Warning signals are always switched on.	

10.6 Language

Changing menu language	MENU / CONFIGURATION / LANGUAGE
<pre> LANGUAGE <=> 4/5 ----- <input type="checkbox"/> POLSKI <input type="checkbox"/> DEUTSCH <input checked="" type="checkbox"/> ENGLISH <input type="checkbox"/> РУССКИЙ <input type="checkbox"/> ESPAÑOL <input type="checkbox"/> SUENSKA <input type="checkbox"/> ITALIANO <input type="checkbox"/> FRANCAIS <input type="checkbox"/> PORTUGUES <input type="checkbox"/> ĆESKY </pre>	<ul style="list-style-type: none"> Via ▲▼ keys choose demanded menu language Mark it by pressing SET.

10.7 Other

Rotor automatic identification	MENU / CONFIGURATION / OTHER
<pre> OTHER <=> 5/5 ----- <input checked="" type="checkbox"/> AUTOMATIC IDENTIF. <input type="checkbox"/> TEMPERATURE: °C <input checked="" type="checkbox"/> TEMPERATURE: °F </pre>	<p>Thanks to the automatic rotor identification, the centrifuge automatically identifies the rotor in the chamber. Rotor identification is indicated by the message.</p> <p>When the function is deactivated, it is necessary to manually select the desired rotor as described in Rotor choosing.</p> <p>The AUTOMATIC IDENTIF. is turned on by default.</p>

<p>SPEED 2000 0 RCF 537 0</p> <p>ROTOR IDENTIFICATION !</p> <p>TIME 00:02:00 0 P °C +20</p> <p>PROG: -- 11740/----- PARAM+ MENU+</p>	<p>To enable the function:</p> <ul style="list-style-type: none"> Via ▲▼ keys choose <ul style="list-style-type: none"> AUTOMATIC IDENTIF. Press SET (◻ change to ◻ or conversely). <p>Autoidentification is not active for work in the loaded program mode.</p>
--	---

<p>Choice of temperature unit</p>	<p>MENU / CONFIGURATION / OTHER</p>
<p>OTHER ◀▶ 5/5</p> <p>◻ AUTOMATIC IDENTIF.</p> <p>◻ TEMPERATURE: °C</p> <p>◻ TEMPERATURE: °F</p>	<p>The TEMPERATURE in °C is turned on by default.</p> <p>To change the temperature unit:</p> <ul style="list-style-type: none"> Via ▲▼ keys select unit Confirm by pressing SET.

<p>TEMPERATURE IN °C</p> <p>SPEED 2000 0 RCF 537 0</p> <p>TEMP 12°C +21</p> <p>TIME 00:02:00 00:02:00</p> <p>PROG: -- 11740/----- PARAM+ MENU+</p>	<p>TEMPERATURE IN °F</p> <p>SPEED 2000 0 RCF 537 0</p> <p>TEMP 53°F 69</p> <p>TIME 00:02:00 00:02:00</p> <p>PROG: -- 11740/----- PARAM+ MENU+</p>
--	---

10.8 Password

<p>Setting up password</p>	<p>MENU / PASSWORD</p>
<p>To prevent from an unauthorized use, a PASSWORD can be set.</p> <p>Note: No PASSWORD is set by default.</p> <p>The PASSWORD can be set as follows when the rotor is at a standstill.</p>	
<p>PASSWORD LOCK:</p> <p>PASSWORD: 1234</p> <p>◻ SAVE PROGRAM</p> <p>◻ DELETE PROGRAM</p> <p>◻ CHANGE PARAMETERS</p> <p>◻ LOAD PROGRAM</p> <p>◻ START KEY</p>	<ul style="list-style-type: none"> With ▲ ▼ keys select the PASSWORD field (is blinking), press SET. With the ▲ ▼ keys select the appropriate digit in the first field, e.g., 1xxx. Press ▶ With the ▲ ▼ keys select the appropriate digit in the second field, e.g., 12xx. Press ▶ Use the ▲ ▼ keys to select the appropriate digit in the third field, e.g., 123x. Press ▶ Use the ▲ ▼ keys to select the correct digit in the fourth field, e.g., 1234. Press SET.

PASSWORD LOCK: CONFIRM: <div style="border: 1px solid black; padding: 2px; display: inline-block;">1234</div>	<input type="checkbox"/> SAVE PROGRAM <input type="checkbox"/> DELETE PROGRAM <input type="checkbox"/> CHANGE PARAMETERS <input type="checkbox"/> LOAD PROGRAM <input type="checkbox"/> START KEY	<ul style="list-style-type: none"> ▪ As a confirmation repeat instructions described above.
PASSWORD LOCK: <div style="border: 1px solid black; padding: 2px; display: inline-block;">****</div>	<input type="checkbox"/> SAVE PROGRAM <input type="checkbox"/> DELETE PROGRAM <input type="checkbox"/> CHANGE PARAMETERS <input type="checkbox"/> LOAD PROGRAM <input type="checkbox"/> START KEY	

When the **PASSWORD** is set, the Key sign is displayed in the **CODE** zone. It is also displayed in the main menu (lower right corner of the screen).

PASSWORD LOCK: <div style="border: 1px solid black; padding: 2px; display: inline-block;">****</div>	<input type="checkbox"/> SAVE PROGRAM <input type="checkbox"/> DELETE PROGRAM <input type="checkbox"/> CHANGE PARAMETERS <input type="checkbox"/> LOAD PROGRAM <input type="checkbox"/> START KEY	<div style="display: flex; justify-content: space-between; align-items: center;"> <div style="text-align: center;"> SPEED 2000 0 </div> <div style="text-align: center;"> RCF 300 0 </div> </div> <hr/> <div style="display: flex; justify-content: space-between; align-items: center;"> <div style="text-align: center;"> TIME 00:02:00 00:02:00 </div> <div style="text-align: center;"> TEMP 20°C +20 </div> </div> <hr/> <div style="display: flex; justify-content: space-between; align-items: center;"> PROG: -- 11199/----- PARAM+ MENU+ </div>
---	---	---

From then on, access to the **MENU** is possible after entering the password.

In case of incorrect password, it will show message: **ACCESS DENIED!**

The removal of an active password is possible after setting the password "0000" (after entering the currently set password). If the password is forgotten, it is possible to use the emergency password "7654", which removes the previous password and all locks. Using both methods will delete the previous password and disable all security features.

Setting up locks

PASSWORD LOCK: <div style="border: 1px solid black; padding: 2px; display: inline-block;">****</div>	<input type="checkbox"/> SAVE PROGRAM <input type="checkbox"/> DELETE PROGRAM <input type="checkbox"/> CHANGE PARAMETERS <input type="checkbox"/> LOAD PROGRAM <input type="checkbox"/> START KEY	<ul style="list-style-type: none"> ▪ With ▲▼ keys choose a lock. ▪ Mark a lock by pressing SET. ▪ Repeat above steps for desired locks. ▪ Leave menu with BACK key.
PASSWORD LOCK: <div style="border: 1px solid black; padding: 2px; display: inline-block;">****</div>	<input type="checkbox"/> SAVE PROGRAM <input type="checkbox"/> DELETE PROGRAM <input type="checkbox"/> CHANGE PARAMETERS <input type="checkbox"/> LOAD PROGRAM <input type="checkbox"/> START KEY	

	Disabled*	description
SAVE PROGRAM	<div style="border: 1px solid gray; padding: 2px;">SAVE</div> button	<ul style="list-style-type: none"> ▪ no programs can be saved
DELETE PROGRAM	<div style="border: 1px solid gray; padding: 2px;">DELETE</div> button	<ul style="list-style-type: none"> no programs can be deleted saving programs on position where one was already stored is disabled
CHANGE PARAMETERS	fields: <div style="text-align: center;"> <div style="border: 1px solid gray; padding: 2px; margin: 2px;">SPEED</div> <div style="border: 1px solid gray; padding: 2px; margin: 2px;">RCF</div> <div style="border: 1px solid gray; padding: 2px; margin: 2px;">TIME</div> <div style="border: 1px solid gray; padding: 2px; margin: 2px;">TEMP</div> <div style="border: 1px solid gray; padding: 2px; margin: 2px;">PROG—</div> <div style="border: 1px solid gray; padding: 2px; margin: 2px;">/</div> <div style="border: 1px solid gray; padding: 2px; margin: 2px;">PARAM</div> <div style="border: 1px solid gray; padding: 2px; margin: 2px;">PROG</div> </div>	parameters can not be modified
LOAD PROGRAM	<div style="border: 1px solid gray; padding: 2px;">LOAD</div> button	no programs can be called up
START KEY	<div style="border: 1px solid gray; padding: 2px;">START</div> key	centrifugation can not be started

* Executing disabled procedures is only possible after entering the correct

10.9 Last 10 cycles

Information concerning parameters of last 10 centrifuging cycles.	MENU / LAST 10 CYCLES
<pre> NO CYCLES:05 ----- DATE/TIME: -- PROGRAM: -- ROTOR/BUCKET: 11740/----- SPEED: 2000 RCF: 537 TIME: 00:02:00 </pre>	<ul style="list-style-type: none"> Number of cycle can be changed by ◀▶ keys. The list can be scrolled using ▲▼ keys. To exit press SET/BACK key

10.10 Work time

Total working time of centrifuge, and quantity of working cycles.	MENU / WORK TIME
<pre> WORK TIME ----- TOTAL RUN TIME: 0h 13m 14s CYCLES: 31 </pre>	<p>In the WORK TIME menu the following statistics are displayed:</p> <ul style="list-style-type: none"> total working (centrifugation) time working cycles counter

10.11 Rotor runtime

Information about the time of centrifuging and of the quantity of the working cycles of each rotor. The table also contains icons warning of the duty of execution of validation.	MENU / ROTOR RUNTIME
<pre> No S ROTOR BUCKET CYCLES NOM.C TIME ----- 1 ✓ 11199 ----- 1 15000 0 0104040 ✓ 11210 ----- 0 15000 0 0104040 ✓ 11211 ----- 0 15000 0 0104040 ✓ 11213 ----- 0 15000 0 0104040 ✓ 11259 ----- 0 15000 0 0104040 ✓ 11273 ----- 0 15000 0 </pre>	<ul style="list-style-type: none"> The list can be scrolled using ▲▼ keys. To exit press BACK key. <p>Symbols:</p> <ul style="list-style-type: none"> ✓ – more than 100 cycles left ! – less than 100 cycles left ■ – worn rotor

10.12 Contact us

Information about the type of the centrifuge, firmware version, and contact details.	MENU / CONTACT US
<pre> CONTACT US MPW-380R 07.9.16 ----- MPW MED. INSTRUMENTS 04-347 WARSAW 46 BOREMLOWSKA STREET WWW.MPW.PL , MPW@MPW.PL SALES DEPARTMENT: </pre>	<p>The list can be scrolled using ▲▼ keys. To exit press BACK key.</p>

10.13 Diagnostics

Information about errors arisen in working of the centrifuge (for service).	MENU / DIAGNOSTICS
<pre> No DATE TIME ERROR ----- 2 -- -- 200 0104040 </pre>	<p>Information on error numbers that occurred during the operation of the centrifuge</p> <p>Intended for service purposes!</p>

10.14 Factory settings

Restoring factory settings.	MENU/ FACTORY SETTINGS
All settings of user programs will be deleted.	
<pre> FACTORY SETTINGS: WARNING! ALL PROGRAMS, SETTINGS AND CONFIGURATION WILL BE LOST. CONTINUE ? YES NO </pre>	<ul style="list-style-type: none"> ▪ Via ◀▶ keys choose YES or NO. ▪ Confirm by pressing SET.

11. Maintenance

11.1 Cleaning of the centrifuge

	<ul style="list-style-type: none"> ▪ Pull the mains plug before cleaning. ▪ Before any cleaning or decontamination process other than that is recommended by the manufacturer, the user has to ask the manufacturer if the planned process does not damage the device ▪ For cleaning, water with soap or other water-soluble mild detergent shall be used. ▪ One should avoid corrosive and aggressive substances. ▪ It is prohibited to use alkaline solutions, inflammable solvents or agents containing abrasive particles. ▪ Do not lubricate the centrifuge motor shaft. ▪ The unused centrifuge should have cover opened. <p style="text-align: center;">Once a week</p> <ul style="list-style-type: none"> ▪ Using wiping cloth, remove condensate or residues of the products from the rotor chamber. <p style="text-align: center;">Once a month</p> <ul style="list-style-type: none"> ▪ Check the condition of the rotor fixing screw thread. If damaged, it must be replaced. ▪ Check the centrifuging chamber whether it is damaged. In case of damage, it cannot be longer put into operation. Notify authorized service workshop.
---	---

11.2 Maintenance of centrifuge elements

	<ul style="list-style-type: none"> ▪ The rotor pins shall be always lubricated with petroleum jelly. ▪ In this way, the uniform deflection of the buckets and quiet centrifuge operation is ensured.
---	--

Cleaning of the accessories

	<ul style="list-style-type: none"> ▪ In order to ensure safe operation, one shall carry out in regular way periodical maintenance of the equipment. ▪ Rotors, buckets, and round carriers have to withstand high stresses originating from the centrifugal force. Chemical reactions as well as corrosion (combination of variable pressure and chemical reactions) can cause destruction of metals. Hard to observe surface cracks increase gradually and weaken material without visible symptoms. ▪ In case of observation of surface damage, crevice, or other change, as well as the corrosion, the given part (rotor, bucket, etc.) shall be immediately replaced.
---	--

- The rotor, including the fixing screw, buckets and round carriers must be regularly cleaned to prevent corrosion.
- Cleaning of the accessories shall be carried out outside of the centrifuge **once every week** or still better after each use. For cleaning them one should use neutral agent of pH value 6÷8. It is forbidden to use alkaline agent of **pH > 8**. Then, those parts shall be dried using soft fabric or in the chamber drier at ca. 50°C.
- Angle rotor should be placed on a fabric with holes facing down, for effective drying.
- Do not use bleach on plastic parts of the rotor.
- In this way, the useful service life of the device is substantially increased and susceptibility to corrosion is diminished. Accurate maintenance increases the service life as well and protects against premature rotor failures.
- Do not use bleach on plastic parts of the rotor.
- According to laboratory standards, minimize the immersion time in each solution.
- Especially prone to the corrosion are parts made of aluminium.
- Corrosion and damages resulting from insufficient maintenance could not be subject of claims lodged against the manufacturer.
- The unused rotor should have the lid removed.

▪ **HS accessories maintenance.**

- 
- Check the general condition of seals.
 - Make sure that rubber O-rings are lightly coated with silicone grease. Use high vacuum grease, e.g., type „C” by LUBRINA.
 - In order to maintain hermetic sealing, it is recommended to replace the sealing rings after each autoclaving.
 - Store hermetically sealed rotors and buckets with the lids removed.

11.3 Sterilization

Plastics - legend to abbreviations

PS	polystyrene	ECTFE	ethylene/chlorotrifluoroethylene
SAN	styrene-acrylonitrile	ETFE	ethylene/tetrafluoroethylene
PMMA	polymethyl methacrylate	PTFE	polytetrafluoroethylene
PC	polycarbonate	FEP	tetrafluoroethylene/perfluoropropylene
PVC	polyvinyl chloride	PFA	tetrafluoroethylene/perfluoroalkylvinylether
POM	acetal polyoxymethylenel	FKM	fluorcarbon rubber
PE-LD	low density polyethylene	EPDM	ethylene propylene diene
PE-HD	high density polyethylene	NR	natural rubber
PP	polypropylene	SI	silicon rubber
PMP	polymethylpentene		

One can use all standard disinfectants. Centrifuges and devices are made of different materials, one should consider their variety.

	radiation β radiation γ 25 kGy	C ₂ H ₄ O (ethylene oxide)	formalin, ethanol
PS	●	○	●
SAN	○	●	●
PMMA	●	○	●
PC	●	●	●
PVC	○	●	●
POM	●	●	●
PE-LD	●	●	●
PE-HD	●	●	●

PP	●	●	●
PMP	●	●	●
ECTFE, ETFE	○	●	●
PTFE	○	●	●
FEP, PFA	○	●	●
FKM	○	●	●
EPDM	○	●	●
NR	○	●	●
SI	○	●	●

- may be used
- cannot be used

In the centrifuge, disinfectants and cleaning agents generally used in medical care should be used (e.g., Aerodesina-2000, Lysoformin 3000, Melseptol, Melsept SF, Sanepidex, Cutasept F).

11.3.1 Autoclaving

- Rotors, buckets and round carriers can be sterilized in autoclave with temperature 121°C during 20 min (215 kPa), unless otherwise specified in the OPTIONAL ACCESSORY.
- During sterilization (autoclaved) by means of steam one should consider temperature resistance of individual materials.
- Deformation of the accessories (carriers or lids made of plastic) may occur during autoclaving.
- Do not autoclave disposable materials (e.g., tubes, cyto-container).
- The life of the accessory depends on the frequency of autoclaving and use.
- Autoclaving reduces lifespan of plastic components. They should be replaced if any signs of damage are visible, including a change in colour or shape or when leakage etc.
- Pressure in closed containers can cause plastic deformation or explosion.
- Prior to autoclaving the rotors and accessories, thoroughly wash and rinse with distilled water.
- Never exceed the permissible autoclaving temperature and time.
- If you want to keep the hermetic seals, replace the sealing rings after each autoclave.

Chemical resistance of plastics

	autoclaving 121 °C, 20 min		autoclaving 121 °C, 20 min
PS	○	PMP	●
SAN	○	ECTFE, ETFE	●
PMMA	○	PTFE	●
PC	●	FEP, PFA	●
PVC	○ ¹⁾	FKM	●
POM	●	EPDM	●
PE-LD	○	NR	○
PE-HD	○	SI	●
PP	●		

- may be used
- cannot be used

1) Except PVC hoses which are resistant to the steam sterilization in the temperature 121°C.

11.4 Chemical resistance



Chemical resistance of plastics

	aldehydes	cyclic alcohols	esters	ether	ketones	strong or concentrated acids	weak or diluted acids	oxidizing substances	cyclic hydrocarbons	ahs	haloid hydrocarbons	alkalis
PS	○	●	○	○	○	○/●	○/●	○	○	○	○	●
SAN	○	●	○	○	○	○	○/●	○	○	○	○	●
PMMA	○/●	●	○	○	○	○	○/●	○	○/●	○	○	○
PC	○/●	●	○	○	○	○	○/●	○	○/●	○	○	○
PVC	○	●	○	○	○	●	●	○	●	○	○	●
POM	○/●	●	○	●	●	○	○	○	●	●	●	●
PE-LD		●	●	●	○/●	●	●	○	●	●	●	●
PE-HD	●	●	○/●	○/●	○/●	●	●	○	●	○/●	○/●	●
PP	●	●	○/●	○/●	○/●	●	●	○	●	○/●	○/●	●
PMP	○/●	●	○/●		○/●	●	●	○	○/●	○	○	●
ECTFE ETFE	●	●	●	●	○	●	●	●	●	●	●	●
PTFE FEP PFA	●	●	●	●	●	●	●	●	●	●	●	●
FKM	●	○	○	○	○	○	●	○/●	○/●	○/●	○/●	○/●
EPDM	●	●	○/●	○	○/●	●	●	○/●	○	○	○	●
NR	○/●	●	○/●	○	○	○	○/●	○	○	○	○	●
SI	○/●	●	○/●	○	○	○	○/●	○	○	○	○	○/●

●	very good	Permanent action of the substance does not cause damage through 30 days. The material is able to be resistant through years
○/●	good to limited	Continuous action of the substance causes insignificant and partly reversible damage through the period of 7-30 days (e.g. puffing up, softening, reduced mechanical durability, discolouring).
○	limited	The material should not have the continuous contact with the substance. The immediate occurrence of damage is possible (e.g. the loss of mechanical durability, deformation, discolouring, bursting, dissolving).







Rubber inserts shall be exactly cleaned or possibly replaced. Centrifuges and accessories are made of different materials.

Do not use bleach on plastic parts of the rotor.

	DANGER! MPW accessories are not biotight. For centrifuging infectious materials, it is necessary to use hermetically closed tubes meeting demands of biotightness, in order to prevent germs migration into the centrifuge and beyond it.
	User is responsible for proper disinfections of the centrifuge if some dangerous material was spilled inside or outside of the centrifuge. During the above mentioned works one must wear safety gloves.

12. Troubleshooting

Majority of faults could be removed by switching the centrifuge OFF and then ON. After switching the centrifuge ON, there shall be displayed parameters of the recently implemented program and sound signals comprising four successive tones shall be generated. In case of short-duration power failure the centrifuge terminates the cycle and displays PROGRAM ERROR code.

problem	question	remedy
Centrifuge does not start	<i>Is supply cable plugged into mains?</i>	<i>Plugs supply cable correctly.</i>
	<i>Is master switch ON?</i>	<i>Switch ON power supply.</i>
Motor error is displayed		Call service.
Centrifuge does not start (indications are proof for cycle in progress and motor does not start)	<i>Is  symbol displayed?</i>	Wait till rotor stops and the  symbol goes off.
	<i>Is  symbol displayed?</i>	Close cover.  symbol must switch off.
	<i>Is  symbol blinking?</i>	Centrifugation cycle in progress, press STOP key or wait till cycle ends.
Centrifuge does not accelerate (unbalance error)	<i>Unequal rotor load.</i>	Centrifuge load shall be balanced.
	<i>Inclined centrifuge.</i>	Centrifuge shall be levelled.
	<i>Faulty drive (mechanical damage).</i>	Call service.
	<i>Was centrifuge displaced during operation?</i>	Switch ON the centrifuge again after opening and closing the cover.
(motor error)	<i>After stopping error rotor message is displayed</i>	Check if rotor number in started program is consistent with the number of the rotor installed in the centrifuge. Check rotor status (if there are coding magnets inserted)
	<i>Centrifuge does not recognize the rotor and does not stop.</i>	Switch the centrifuge OFF, then ON and check correctness of loaded program
It is not possible to open the cover	<i> symbol on the display is blinking, after pressing COVER key single tone is audible</i>	Rotor is still rotating. Wait for stopping of the rotor and displaying of the  symbol.
	<i>The sensor is connected correctly, and the error is still applying.</i>	Call service.
Mains failure during run	<i>The message will be displayed on the display about the decay of tension.</i>	Wait for stopping of the rotor, clear the error by pressing the SET key.
Temperature sensor error	<i>The overheating message will be displayed.</i>	Switch the centrifuge OFF, then ON.
		Call service.
Error of the exceeding the temperature (50°C) in the chamber	<i>The overheating message will be displayed.</i>	Call service.

12.1 Messages

Screen messages that may occur during operation.	
MESSAGE	EXPLANATION
"SPEED OF ROTOR" "IDENTIFICATION <> 90 RPM"	Please try start centrifuging again, if error still occur, contact manufacturer's authorized service.
"IMBALANCE FAST STOP !" "PLEASE REMOVE CAUSE" "THEN RESTART"	Rotor is not balanced correctly, please balance rotor.
"NO ROTOR OR IDENTIFICATION" "SENSOR DAMAGED !"	Make sure, is rotor mounted in the centrifuge chamber. If it is right contact manufacturer's authorized service.

"INCORRECT ROTOR NUMBER !"	Change rotor number in centrifuge settings or use autoidentification.
"WRONG DIRECTION OF ROTATION" "OR UNKNOWN ROTOR !"	Make sure if correct rotor for centrifuge is mounted. List of accessories is described in chapter 15.
"PLEASE CLOSE THE LID" "HAND !"	Necessity of manually closing the lid.
"ROTOR STOPPING !" "Please wait..."	Initializing after mains failure with rotating rotor, wait until rotor stop.

Emergency messages

In case of emergency messages (centrifuge is not working properly) contact the manufacturer's authorized service centre.

MESSAGE
"OVERHEATING MOTOR !" "INVERTER ERROR !"
"INVERTER SERIAL BUS ERROR !"
"TEMPERATURE SENSOR ERROR"
"PRESSURE CONTROL FAILURE!"
"OPENING COVER in RUN!"
"SPEED METER ERROR"
"I2C BUS ERROR"
"OVERHEATING CENTRIFUGE !"
"ROTOR OVERSPEED !"
"COVER LOCK MALFUNCTION !"

12.2 Emergency cover release

	<p>EMERGENCY COVER RELEASE</p> <p>Attention! <i>The cover may be opened in emergency only when the rotor is at rest. Before emergency opening the cover, switch off the mains power switch and disconnect the power cord. Wait 10 min and/or looking through the sight glass, make sure that the rotor is not rotating.</i></p> <p>To do this, insert the key into the emergency opening of the cover (Cat. No. 17799) into the hole (you must first remove the plug) on the front of the centrifuge and then turn it anticlockwise until you release the lock and open the cover.</p>
---	--

13. Guarantee

Manufacturer grants to the Buyer the guarantee on conditions specified in the Guarantee Certificate. Buyer forfeits the right to guarantee repair when using the device inconsistently with the User manual provisions, when damage results from the User’s fault.

Repairs should be carried out in authorized service workshops, granted with the MPW Certificate.

The centrifuge shall be sent to repair after decontaminating disinfections. Information about authorized service workshops could be obtained from the Manufacturer.

	<ul style="list-style-type: none"> ▪ Guarantee period amounts to 24 months (unless otherwise specified in the purchase documents). ▪ Guarantee conditions are described in guaranteed card. ▪ The service life of the centrifuge specified by the manufacturer amounts to 10 years. ▪ After 24 months from the start of the warranty period (date of purchase), a technical inspection of the centrifuge should be carried out (validation) by an authorized service of the manufacturer. Subsequent inspections should be carried out at annual intervals. ▪ Maximum period of storage of not used centrifuge amounts to 1 year. After this period, a service authorized by manufacturer should carry out technical inspection of the centrifuge. ▪ Manufacturer reserves the right to make technical changes in manufactured products.
---	--

14. Transport and storage

	<p>CAUTION! Due to the heavy weight of the device, lifting and carrying it may cause injury to the spine.</p>
<ul style="list-style-type: none"> ▪ Store the device only in a closed and dry room. ▪ Remove rotor from centrifuge before transport. ▪ Lift and carry with the adequate number of people. ▪ Use transport equipment. ▪ Use the original packaging and transport protection for transport. 	

Transport and storage conditions.

	Storage (in the package)	Storage (without the package)	Transport
Temperature	-25 ÷ +55 °C	-5 ÷ +45 °C	-25 ÷ +60 °C (general) -20 ÷ +55 °C (air)
Relative humidity	10 ÷ 75 %	10 ÷ 75 %	10 ÷ 75 %
Pressure	70 ÷ 106 kPa	70 ÷ 106 kPa	30 ÷ 106 kPa

15. Disposal



- Dispose of the device in accordance with the applicable legal regulations in the country of use.
- In the countries of the European Community, the disposal of electrical equipment is regulated under the EU Directive 2012/19/EU on waste electrical and electronic equipment (WEEE).
According to these regulations, centrifuges may not be collected together with municipal or household waste.
- Disposal regulations in individual EU countries may differ. In case of doubt, please contact the supplier of the device.

16. List of changes in the manual

Rev.	Release date	Description of changes
15	03.04.2023	Addition of markings used in the manual and on the device. Update of nameplate, CE declaration and equipment lists. Updating records regarding the intended use and disposal of the product. Removal of the RTC function.
16	16.06.2023	Updating of the description in the technical data table. Updating the CE declaration of conformity, equipment list and nameplate.

17. Manufacturer's info

"MPW MED. INSTRUMENTS" SPÓŁDZIELNIA PRACY

Boremlowska 46 Street

04-347 Warsaw

tel. (+48) 22 610 56 67 (sales department - POLAND)
(+48) 22 879 70 46 (sales department - outside POLAND)
(+48) 22 610 81 07 (service)

fax: (+48) 22 610 55 36

e-mail: mpw@mpw.pl

website: www.mpw.pl

000042924 - number of entry in the Waste Database

PL/CA01-01782 - identification number given by Office for Registration of Medicinal Products, Medical Devices and Biocidal Products.

Distributor's info

DISTRIBUTOR:

18. ANNEXES

A. Wyposażenie dodatkowe/Optional accessories
MPW-380/R
WIRNIK / ROTOR

 PARAMETRY/PARAMETERS (RCF [x g], Rmax [mm], α [°])

POJEMNIK/BUCKET

WKŁADKA / ADAPTER

[liczba probówek na wirnik/tubes per rotor] PROBÓWKA / TUBE

11762
RPM 18000 RCF 30065 Rmax 83 α 45
bez pojemnika/without bucket
bez wkładki/without adapter

[36] * 2-1,5 ml probówka (10,8x41,8 mm), Eppendorf®; [15011], 2 ml (10,8x41,8 mm); [15128], 1,5ml (10,8x40,5 mm)

 [36] * 2 ml probówki z filtrem - spin columns (10,8 x 46 mm)
 2 ml spin columns (with filter) (10,8 x 46 mm); [15011], 2 ml (10,8x41,8 mm); [15128], 1,5ml
14084

 [36] * 0,5 ml probówka PCR (7,8 x 31 mm)
 0,5 ml PCR tube (7,8 x 31 mm)
14126

 [36] * 0,4 ml probówka PCR (5,7 x 48,6 mm)
 0,4 ml PCR tube (5,7 x 48,6 mm)
14133

 [36] * 0,2 ml probówka PCR (6 x 21,6 mm)
 0,2 ml PCR tube (6 x 21,6 mm)

11763
RPM 16400 RCF 28266 Rmax 94 α 45
bez pojemnika/without bucket
bez wkładki/without adapter

[48] * 2-1,5 ml probówka (10,8x41,8 mm), Eppendorf®; [15011], 2 ml (10,8x41,8 mm); [15128], 1,5ml (10,8x40,5 mm)

 [48] * 2 ml probówki z filtrem - spin columns (10,8 x 46 mm)
 2 ml spin columns (with filter) (10,8 x 46 mm); [15011], 2 ml (10,8x41,8 mm); [15128], 1,5ml
14084

 [48] * 0,5 ml probówka PCR (7,8 x 31 mm)
 0,5 ml PCR tube (7,8 x 31 mm)
14126

 [48] * 0,4 ml probówka PCR (5,7 x 48,6 mm)
 0,4 ml PCR tube (5,7 x 48,6 mm)
14133

 [48] * 0,2 ml probówka PCR (6 x 21,6 mm)
 0,2 ml PCR tube (6 x 21,6 mm)

11765
RPM 16400 RCF 28566 Rmax 95 α 45
bez pojemnika/without bucket
bez wkładki/without adapter

 [12] * 8 x 0,2 ml probówki szeregowo PCR-strip (10,2 x 72,4 mm)
 8 x 0,2 ml PCR strip (10,2 x 72,4 mm)

 [96] * 0,2 ml probówka PCR (6 x 21,6 mm)
 0,2 ml PCR tube (6 x 21,6 mm)

11766
RPM 18000 RCF 31876 Rmax 88 α 45
bez pojemnika/without bucket
bez wkładki/without adapter

 [12] 15121 10 ml probówka z dnem okrągłym i pokrywką (17 x 70 mm)
 10 ml tube, round bottom, with cap (17 x 70 mm)

[12] * 10 ml Thermo Nalgene® Oak Ridge (16 x 81,5 mm)

11767
RPM 14000 RCF 20598 Rmax 94 α 30
bez pojemnika/without bucket
bez wkładki/without adapter

A. Wyposażenie dodatkowe/Optional accessories	
MPW-380/R	
[12]	15118 10 ml probówka szklana (16 x 100 mm) 10 ml glass tube (16 x 100 mm) RCF max.=3000 RPM max.=5343
[12]	* 10 ml probówka z pokrywką (16 x 106 mm) 10 ml tube with cap (16 x 106 mm)
11769	
RPM 16400 RCF 29168 Rmax 97 \pm 45	
bez pojemnika/without bucket bez wkładki/without adapter	
[60]	* 2-1,5 ml probówka (10,8x41,8 mm), Eppendorf®; [15011], 2 ml (10,8x41,8 mm); [15128], 1,5ml (10,8x40,5 mm)
[60]	* 2 ml probówki z filtrem - spin columns (10,8 x 46 mm) 2 ml spin columns (with filter) (10,8 x 46 mm); [15011], 2 ml (10,8x41,8 mm); [15128], 1,5ml 14084
[60]	* 0,5 ml probówka PCR (7,8 x 31 mm) 0,5 ml PCR tube (7,8 x 31 mm) 14126
[60]	* 0,4 ml probówka PCR (5,7 x 48,6 mm) 0,4 ml PCR tube (5,7 x 48,6 mm) 14133
[60]	* 0,2 ml probówka PCR (6 x 21,6 mm) 0,2 ml PCR tube (6 x 21,6 mm)
11770	
RPM 14000 RCF 23228 Rmax 106 \pm 30	
bez pojemnika/without bucket bez wkładki/without adapter	
[12]	* 15 ml probówka z dnem stożkowym z zakrętką (17 x 120 mm), Falcon®; [15050], 15ml (17 x 120 mm) 15 ml tube, conical bottom, with cap (17 x 120 mm), Falcon®; [15050] 15ml Sarstedt®(17 x 120 14047
[12]	* 5 ml probówka z korkiem (12 x 85 mm), Sarstedt® 5 ml tube with cap (12 x 85 mm), Sarstedt® 14868
[12]	* 5 ml probówka z korkiem wciskany (17 x 54,2 mm), Eppendorf® 5 ml tube with snap cap (17 x 54,2 mm), Eppendorf®
[12]	* 5 ml probówka z korkiem zakręcany (17 x 66 mm), Eppendorf® 5 ml tube with screw cap (17 x 66 mm), Eppendorf®
11772	
RPM 17500 RCF 29788 Rmax 87 \pm 30	
bez pojemnika/without bucket bez wkładki/without adapter	
[8]	* 30 ml probówka z pokrywką (25,5 x 94 mm), Nalgene® 30 ml tube with cap (25,5 x 94 mm), Nalgene®
[8]	* 30 ml Thermo Nalgene® Oak Ridge (25,5 x 94,3 mm) 30 ml Thermo Nalgene® Oak Ridge (25,5 x 94,3 mm)
11773	
RPM 14500 RCF 21625 Rmax 92 \pm 30	
bez pojemnika/without bucket bez wkładki/without adapter	
[6]	15051 50 ml Thermo Nalgene® Oak Ridge (28,8 x 106,7 mm) 50 ml Thermo Nalgene® Oak Ridge (28,8 x 106,7 mm) 14035
[6]	15046 14 ml probówka z pokrywką (16,8 x 113,7 mm), Sarstedt® 14 ml tube with cap (16,8 x 113,7 mm), Sarstedt®
[6]	* 10 ml probówka z pokrywką (16 x 106 mm) 10 ml tube with cap (16 x 106 mm) 14036
[6]	* 6 ml probówka z pokrywką (11,5 x 92 mm), Sarstedt® 6 ml tube with cap (11,5 x 92 mm), Sarstedt®
11775	
RPM 14000 RCF 21255 Rmax 97 \pm 30	
bez pojemnika/without bucket bez wkładki/without adapter	
[8]	15051 50 ml Thermo Nalgene® Oak Ridge (28,8 x 106,7 mm) 50 ml Thermo Nalgene® Oak Ridge (28,8 x 106,7 mm) 14035

* probówka niedostępna w ofercie MPW lub dostępny odpowiednik (np.[15050]), patrz kolumna z prawej
tube is not offered by MPW or equivalent is available (e.g. [15050]), see column on the right

A. Wyposażenie dodatkowe/Optional accessories	
MPW-380/R	
[8]	15046 14 ml probówka z pokrywką (16,8 x 113,7 mm), Sarstedt® 14 ml tube with cap (16,8 x 113,7 mm), Sarstedt®
[8]	15118 10 ml probówka szklana (16 x 100 mm) 10 ml glass tube (16 x 100 mm) RCF max.=3000 RPM max.=5260
[8]	* 15 ml Thermo Nalgene® (16 x 113 mm) 15 ml Thermo Nalgene® (16 x 113 mm)
[8]	* 10 ml probówka z pokrywką (16 x 106 mm) 10 ml tube with cap (16 x 106 mm)
14036	
[8]	* 7 ml probówka szklana (12 x 100 mm) 7 ml glass tube (12 x 100 mm) RCF max.=3000 RPM max.=5260
[8]	* 6 ml probówka z pokrywką (11,5 x 92 mm), Sarstedt® 6 ml tube with cap (11,5 x 92 mm), Sarstedt®
11776	
RPM 14000 RCF 23666 Rmax 108 \pm 30	
bez pojemnika/without bucket	
bez wkładki/without adapter	
[8]	* 50 ml probówka z dnem stożkowym z zakrętką (30 x 117 mm), Falcon®; [15052] 50ml (30 x 117mm) 50 ml tube, conical bottom, with cap (30 x 117 mm), Falcon®; [15052] 50ml Sarstedt® (30 x 117
[8]	* 50 ml probówka z dnem stożkowym bez rantu (30 x 115 mm), Greiner® 50 ml tube, conical bottom, without skirt (30 x 115 mm), Greiner®
14043	
[8]	* Greiner Vacuette® (13 x 75 mm), (1-4,5 ml)
[8]	* 5 ml probówka z korkiem (12 x 85 mm), Sarstedt® 5 ml tube with cap (12 x 85 mm), Sarstedt®
[8]	* 5 ml probówka szklana (12 x 75 mm) 5 ml glass tube (12 x 75 mm) RCF max.=3000 RPM max.=4985
14071	
[8]	15055 30 ml probówka z pokrywką (25,4 x 103,2 mm) 30 ml tube with cap (25,4 x 103,2 mm)
[8]	* 28 ml Thermo Nalgene® Oak Ridge (25,4 x 101,8 mm)
[8]	* 30 ml probówka z pokrywką (25,5 x 94 mm), Nalgene® 30 ml tube with cap (25,5 x 94 mm), Nalgene®
[8]	* 30 ml Thermo Nalgene® Oak Ridge (25,5 x 94,3 mm) 30 ml Thermo Nalgene® Oak Ridge (25,5 x 94,3 mm)
14073	
[8]	15046 14 ml probówka z pokrywką (16,8 x 113,7 mm), Sarstedt® 14 ml tube with cap (16,8 x 113,7 mm), Sarstedt®
[8]	* BD Vacutainer® (16 x 100 mm), (2,5-11 ml)
[8]	* Greiner Vacuette® (16 x 100 mm), (7-9 ml)
[8]	* Sarstedt S-Monovette® (15 x 92 mm), (7,5; 8,2; 8,5 ml)
[8]	* Sarstedt S-Monovette® (16 x 92 mm), (9; 10 ml)
[8]	15118 10 ml probówka szklana (16 x 100 mm) 10 ml glass tube (16 x 100 mm) RCF max.=3000 RPM max.=4985
[8]	* 10 ml probówka z pokrywką (16 x 106 mm) 10 ml tube with cap (16 x 106 mm)
14089	
[8]	* 15 ml probówka z dnem stożkowym z zakrętką (17 x 120 mm), Falcon®; [15050], 15ml (17 x 120 mm) 15 ml tube, conical bottom, with cap (17 x 120 mm), Falcon®; [15050] 15ml Sarstedt®(17 x 120 mm)
14089+14868	
[8]	* 5 ml probówka z korkiem wciskany (17 x 54,2 mm), Eppendorf® 5 ml tube with snap cap (17 x 54,2 mm), Eppendorf®
[8]	* 5 ml probówka z korkiem zakręcany (17 x 66 mm), Eppendorf® 5 ml tube with screw cap (17 x 66 mm), Eppendorf®
11777	
RPM 10000 RCF 14087 Rmax 126 \pm 25	
bez pojemnika/without bucket	
bez wkładki/without adapter	
[4]	15175 250 ml butelka płaskodenna (62 x 122 mm), Herolab® nr 25 34 21 250 ml bottle, flat bottom (62 x 122 mm), Herolab® no. 25 34 21
[4]	15176 250 ml butelka płaskodenna (62 x 122 mm), Herolab® nr 25 34 01 250 ml bottle, flat bottom (62 x 122 mm), Herolab® no. 25 34 01
14017	
[4]	* 250 ml butelka okrągłodenna (62 x 122 mm), Herolab® nr 25 34 43 250 ml round-bottom bottle (62 x 122 mm), Herolab® no. 25 34 43

* probówka niedostępna w ofercie MPW lub dostępny odpowiednik (np.[15050]), patrz kolumna z prawej
tube is not offered by MPW or equivalent is available (e.g. [15050]), see column on the right

A. Wyposażenie dodatkowe/Optional accessories
MPW-380/R
14152

- [4] * 50 ml probówka z dnem stożkowym z zakrętką (30 x 117 mm), Falcon®; [15052] 50ml (30 x 117mm)
50 ml tube, conical bottom, with cap (30 x 117 mm), Falcon®; [15052] 50ml Sarstedt® (30 x 117)
- [4] * 50 ml probówka z dnem stożkowym bez rantu (30 x 115 mm), Greiner®
50 ml tube, conical bottom, without skirt (30 x 115 mm), Greiner®

14175

- [4] 15175 250 ml butelka płaskodenna (62 x 122 mm), Herolab® nr 25 34 21
250 ml bottle, flat bottom (62 x 122 mm), Herolab® no. 25 34 21
- [4] 15176 250 ml butelka płaskodenna (62 x 122 mm), Herolab® nr 25 34 01
250 ml bottle, flat bottom (62 x 122 mm), Herolab® no. 25 34 01

11778
RPM 12000 RCF 17709 Rmax 110 α 30
bez pojemnika/without bucket
bez wkładki/without adapter

- [6] * 85 ml Thermo Nalgene® Oak Ridge (38,2 x 105,7 mm)
85 ml Thermo Nalgene® Oak Ridge (38,2 x 105,7 mm)

14855

- [6] * 50 ml probówka z dnem stożkowym z zakrętką (30 x 117 mm), Falcon®; [15052] 50ml (30 x 117mm)
50 ml tube, conical bottom, with cap (30 x 117 mm), Falcon®; [15052] 50ml Sarstedt® (30 x 117)
- [6] * 50 ml probówka z dnem stożkowym bez rantu (30 x 115 mm), Greiner®
50 ml tube, conical bottom, without skirt (30 x 115 mm), Greiner®

14856

- [6] * 15 ml probówka z dnem stożkowym z zakrętką (17 x 120 mm), Falcon®; [15050], 15ml (17 x 120 mm)
15 ml tube, conical bottom, with cap (17 x 120 mm), Falcon®; [15050] 15ml Sarstedt®(17 x 120 mm)

11779
RPM 15000 RCF 22136 Rmax 88 α 45
bez pojemnika/without bucket
bez wkładki/without adapter

- [36] * 2-1,5 ml probówka (10,8x41,8 mm), Eppendorf®; [15011], 2 ml (10,8x41,8 mm); [15128], 1,5ml
(10,8x40,5 mm)
- [36] * 2 ml probówki z filtrem - spin columns (10,8 x 46 mm)
2 ml spin columns (with filter) (10,8 x 46 mm); [15011], 2 ml (10,8x41,8 mm); [15128], 1,5ml

14084

- [36] * 0,5 ml probówka PCR (7,8 x 31 mm)
0,5 ml PCR tube (7,8 x 31 mm)

14126

- [36] * 0,4 ml probówka PCR (5,7 x 48,6 mm)
0,4 ml PCR tube (5,7 x 48,6 mm)

14133

- [36] * 0,2 ml probówka PCR (6 x 21,6 mm)
0,2 ml PCR tube (6 x 21,6 mm)

11780
RPM 4500 RCF 3328 Rmax 147 α 30
13276
bez wkładki/without adapter

- [12] 15051 50 ml Thermo Nalgene® Oak Ridge (28,8 x 106,7 mm)
50 ml Thermo Nalgene® Oak Ridge (28,8 x 106,7 mm)
- [12] * 50 ml probówka z dnem stożkowym z zakrętką (30 x 117 mm), Falcon®; [15052] 50ml (30 x 117mm)
50 ml tube, conical bottom, with cap (30 x 117 mm), Falcon®; [15052] 50ml Sarstedt® (30 x 117)
- [12] * 50 ml probówka z dnem stożkowym bez rantu (30 x 115 mm), Greiner®
50 ml tube, conical bottom, without skirt (30 x 115 mm), Greiner®
- [12] * 50 ml probówka Advanced Oak Ridge (29x102 mm), Herolab® nr 25 32 11
50 ml tube, Advanced Oak Ridge (29 x 102 mm), Herolab® no. 25 32 11

14035

- [12] 15046 14 ml probówka z pokrywką (16,8 x 113,7 mm), Sarstedt®
14 ml tube with cap (16,8 x 113,7 mm), Sarstedt®
- [12] 15118 10 ml probówka szklana (16 x 100 mm)
10 ml glass tube (16 x 100 mm)
RCF max.=3000 RPM max.=4272

- [12] * 15 ml Thermo Nalgene® (16 x 113 mm)
15 ml Thermo Nalgene® (16 x 113 mm)

- [12] * 10 ml probówka z pokrywką (16 x 106 mm)
10 ml tube with cap (16 x 106 mm)

14036

- [12] * BD Vacutainer® (13 x 100 mm), (4-7 ml)
- [12] * 7 ml probówka szklana (12 x 100 mm)
7 ml glass tube (12 x 100 mm)
RCF max.=3000 RPM max.=4272

A. Wyposażenie dodatkowe/Optional accessories
MPW-380/R

[12]	*	6 ml probówka z pokrywką (11,5 x 92 mm), Sarstedt® 6 ml tube with cap (11,5 x 92 mm), Sarstedt® 14043
[12]	*	Greiner Vacuette® (13 x 75 mm), (1-4,5 ml)
[12]	*	Sarstedt S-Monovette® (13 x 75 mm), (2,7; 3; 4,3 ml)
[12]	*	Sarstedt S-Monovette® (13 x 90 mm), (4,9; 5,6 ml)
[12]	*	5 ml probówka z korkiem (12 x 85 mm), Sarstedt® 5 ml tube with cap (12 x 85 mm), Sarstedt®
[12]	*	5 ml probówka szklana (12 x 75 mm) 5 ml glass tube (12 x 75 mm) RCF max.=3000 RPM max.=4272 14071
[12]	15055	30 ml probówka z pokrywką (25,4 x 103,2 mm) 30 ml tube with cap (25,4 x 103,2 mm)
[12]	*	28 ml Thermo Nalgene® Oak Ridge (25,4 x 101,8 mm)
[12]	*	30 ml probówka z pokrywką (25,5 x 94 mm), Nalgene® 30 ml tube with cap (25,5 x 94 mm), Nalgene®
[12]	*	30 ml Thermo Nalgene® Oak Ridge (25,5 x 94,3 mm) 30 ml Thermo Nalgene® Oak Ridge (25,5 x 94,3 mm) 14073
[12]	15046	14 ml probówka z pokrywką (16,8 x 113,7 mm), Sarstedt® 14 ml tube with cap (16,8 x 113,7 mm), Sarstedt®
[12]	*	BD Vacutainer® (16 x 100 mm), (2,5-11 ml)
[12]	*	Greiner Vacuette® (16 x 100 mm), (7-9 ml)
[12]	*	Sarstedt S-Monovette® (15 x 92 mm), (7,5; 8,2; 8,5 ml)
[12]	*	Sarstedt S-Monovette® (16 x 92 mm), (9; 10 ml)
[12]	15118	10 ml probówka szklana (16 x 100 mm) 10 ml glass tube (16 x 100 mm) RCF max.=3000 RPM max.=4272
[12]	*	10 ml probówka z pokrywką (16 x 106 mm) 10 ml tube with cap (16 x 106 mm) 14089
[12]	*	15 ml probówka z dnem stożkowym z zakrętką (17 x 120 mm), Falcon®; [15050], 15ml (17 x 120 mm) 15 ml tube, conical bottom, with cap (17 x 120 mm), Falcon®; [15050] 15ml Sarstedt®(17 x 120 14248
[12]	15055	30 ml probówka z pokrywką (25,4 x 103,2 mm) 30 ml tube with cap (25,4 x 103,2 mm) 14089+14868
[12]	*	5 ml probówka z korkiem wciskany (17 x 54,2 mm), Eppendorf® 5 ml tube with snap cap (17 x 54,2 mm), Eppendorf®
[12]	*	5 ml probówka z korkiem zakręcany (17 x 66 mm), Eppendorf® 5 ml tube with screw cap (17 x 66 mm), Eppendorf® 13278+17151
		bez wkładki/without adapter
[12]	15051	50 ml Thermo Nalgene® Oak Ridge (28,8 x 106,7 mm) 50 ml Thermo Nalgene® Oak Ridge (28,8 x 106,7 mm)
[12]	*	50 ml probówka z dnem stożkowym z zakrętką (30 x 117 mm), Falcon®; [15052] 50ml (30 x 117mm) 50 ml tube, conical bottom, with cap (30 x 117 mm), Falcon®; [15052] 50ml Sarstedt® (30 x 117
[12]	*	50 ml probówka z dnem stożkowym bez rantu (30 x 115 mm), Greiner® 50 ml tube, conical bottom, without skirt (30 x 115 mm), Greiner®
[12]	*	50 ml probówka Advanced Oak Ridge (29x102 mm), Herolab® nr 25 32 11 50 ml tube, Advanced Oak Ridge (29 x 102 mm), Herolab® no. 25 32 11 14035
[12]	15046	14 ml probówka z pokrywką (16,8 x 113,7 mm), Sarstedt® 14 ml tube with cap (16,8 x 113,7 mm), Sarstedt®
[12]	15118	10 ml probówka szklana (16 x 100 mm) 10 ml glass tube (16 x 100 mm) RCF max.=3000 RPM max.=4272
[12]	*	15 ml Thermo Nalgene® (16 x 113 mm) 15 ml Thermo Nalgene® (16 x 113 mm)
[12]	*	10 ml probówka z pokrywką (16 x 106 mm) 10 ml tube with cap (16 x 106 mm) 14036
[12]	*	7 ml probówka szklana (12 x 100 mm) 7 ml glass tube (12 x 100 mm) RCF max.=3000 RPM max.=4272
[12]	*	6 ml probówka z pokrywką (11,5 x 92 mm), Sarstedt® 6 ml tube with cap (11,5 x 92 mm), Sarstedt® 14043
[12]	*	Greiner Vacuette® (13 x 75 mm), (1-4,5 ml)

* probówka niedostępna w ofercie MPW lub dostępny odpowiednik (np.[15050]), patrz kolumna z prawej
tube is not offered by MPW or equivalent is available (e.g. [15050]), see column on the right

A. Wyposażenie dodatkowe/Optional accessories
MPW-380/R

[12]	*	5 ml probówka z korkiem (12 x 85 mm), Sarstedt® 5 ml tube with cap (12 x 85 mm), Sarstedt®
[12]	*	5 ml probówka szklana (12 x 75 mm) 5 ml glass tube (12 x 75 mm) RCF max.=3000 RPM max.=4272
14071		
[12]	15055	30 ml probówka z pokrywką (25,4 x 103,2 mm) 30 ml tube with cap (25,4 x 103,2 mm)
[12]	*	28 ml Thermo Nalgene® Oak Ridge (25,4 x 101,8 mm)
[12]	*	30 ml probówka z pokrywką (25,5 x 94 mm), Nalgene® 30 ml tube with cap (25,5 x 94 mm), Nalgene®
[12]	*	30 ml Thermo Nalgene® Oak Ridge (25,5 x 94,3 mm) 30 ml Thermo Nalgene® Oak Ridge (25,5 x 94,3 mm)
14073		
[12]	15046	14 ml probówka z pokrywką (16,8 x 113,7 mm), Sarstedt® 14 ml tube with cap (16,8 x 113,7 mm), Sarstedt®
[12]	*	BD Vacutainer® (16 x 100 mm), (2,5-11 ml)
[12]	*	Greiner Vacuette® (16 x 100 mm), (7-9 ml)
[12]	*	Sarstedt S-Monovette® (15 x 92 mm), (7,5; 8,2; 8,5 ml)
[12]	*	Sarstedt S-Monovette® (16 x 92 mm), (9; 10 ml)
[12]	15118	10 ml probówka szklana (16 x 100 mm) 10 ml glass tube (16 x 100 mm) RCF max.=3000 RPM max.=4272
[12]	*	10 ml probówka z pokrywką (16 x 106 mm) 10 ml tube with cap (16 x 106 mm)
14089		
[12]	*	15 ml probówka z dnem stożkowym z zakrętką (17 x 120 mm), Falcon®; [15050], 15ml (17 x 120 mm) 15 ml tube, conical bottom, with cap (17 x 120 mm), Falcon®; [15050] 15ml Sarstedt®(17 x 120
14248		
[12]	15055	30 ml probówka z pokrywką (25,4 x 103,2 mm) 30 ml tube with cap (25,4 x 103,2 mm)
14089+14868		
[12]	*	5 ml probówka z korkiem wciskany (17 x 54,2 mm), Eppendorf® 5 ml tube with snap cap (17 x 54,2 mm), Eppendorf®
11789		
RPM 4700 RCF 4297 Rmax 174 ± 30		
13080		
14082		
[48]	*	BD Vacutainer® (13 x 100 mm), (4-7 ml)
[48]	*	Greiner Vacuette® (13 x 100 mm), (3,5-6 ml)
[48]	*	Sarstedt S-Monovette® (11 x 92 mm), (4,5; 5 ml)
[48]	*	7 ml probówka szklana (12 x 100 mm) 7 ml glass tube (12 x 100 mm) RCF max.=3000 RPM max.=3927
[48]	*	6 ml probówka z pokrywką (11,5 x 92 mm), Sarstedt® 6 ml tube with cap (11,5 x 92 mm), Sarstedt®
bez wkładki/without adapter		
[48]	15046	14 ml probówka z pokrywką (16,8 x 113,7 mm), Sarstedt® 14 ml tube with cap (16,8 x 113,7 mm), Sarstedt®
[48]	*	15 ml probówka z dnem stożkowym z zakrętką (17 x 120 mm), Falcon®; [15050], 15ml (17 x 120 mm) 15 ml tube, conical bottom, with cap (17 x 120 mm), Falcon®; [15050] 15ml Sarstedt®(17 x 120
[48]	*	BD Vacutainer® (16 x 100 mm), (2,5-11 ml)
[48]	*	Greiner Vacuette® (16 x 100 mm), (7-9 ml)
[48]	*	Sarstedt S-Monovette® (15 x 92 mm), (7,5; 8,2; 8,5 ml)
[48]	*	Sarstedt S-Monovette® (16 x 92 mm), (9; 10 ml)
[48]	15118	10 ml probówka szklana (16 x 100 mm) 10 ml glass tube (16 x 100 mm) RCF max.=3000 RPM max.=3927
[48]	*	15 ml Thermo Nalgene® (16 x 113 mm) 15 ml Thermo Nalgene® (16 x 113 mm)
[48]	*	10 ml probówka z pokrywką (16 x 106 mm) 10 ml tube with cap (16 x 106 mm)
14082+14815		
[48]	*	5 ml probówka szklana (12 x 75 mm) 5 ml glass tube (12 x 75 mm) RCF max.=3000 RPM max.=4147
14082+14815 Rmax 156 RCF 3853		
[48]	*	BD Vacutainer® (13 x 75 mm), (1,6-5,3 ml)
[48]	*	Greiner Vacuette® (13 x 75 mm), (1-4,5 ml)
[48]	*	Sarstedt S-Monovette® (11 x 66 mm), (1,6; 2; 2,7; 3; 3,1 ml)

* probówka niedostępna w ofercie MPW lub dostępny odpowiednik (np.[15050]), patrz kolumna z prawej
tube is not offered by MPW or equivalent is available (e.g. [15050]), see column on the right

A. Wyposażenie dodatkowe/Optional accessories
MPW-380/R

[48]	*	Sarstedt S-Monovette® (13 x 65 mm), (2,6; 2,9; 3,4; 3,8 ml)
[48]	*	Sarstedt S-Monovette® (13 x 75 mm), (2,7; 3; 4,3 ml)
		14815 Rmax 156 RCF 3853
[48]	15121	10 ml probówka z dnem okrągłym i pokrywką (17 x 70 mm) 10 ml tube, round bottom, with cap (17 x 70 mm)
[48]	*	Sarstedt S-Monovette® (15 x 75 mm), (4; 4,3; 5,5 ml)
[48]	*	10 ml Thermo Nalgene® Oak Ridge (16 x 81,5 mm)
12787		
		RPM 4300 RCF 2398 Rmax 116 ϕ 90
13286		
bez wkładki/without adapter		
[2]	*	płytki titracyjna DWP 96/2000µl (127,8x85,5x44,1 mm) deepwell plate DWP 96/2000µl (127,8 x 85,5 x 44,1 mm)
[4]	*	płytki titracyjna MTP 28,8ml (86x128x15/17,5 mm) microtiter plate MTP 28,8 ml (86 x 128 x 15/17,5 mm)
12788		
		RPM 4000 RCF 2826 Rmax 158 ϕ 90
13789		
bez wkładki/without adapter		
[4]	*	płytki titracyjna DWP 96/2000µl (127,8x85,5x44,1 mm) deepwell plate DWP 96/2000µl (127,8 x 85,5 x 44,1 mm)
[8]	*	płytki titracyjna MTP 28,8ml (86x128x15/17,5 mm) microtiter plate MTP 28,8 ml (86 x 128 x 15/17,5 mm)
12791		
		RPM 2500 RCF 1293 Rmax 185 ϕ 90
13792+17792		
14794		
[4]	*	100 ml pojemnik szklany ASTM (96 x 160 mm) 100 ml ASTM glass bucket (96 x 160 mm)
14795		
[4]	*	100 ml pojemnik szklany ASTM (96 x 167 mm) 100 ml ASTM glass bucket (96 x 167 mm)
12870		
		RPM 4000 RCF 3309 Rmax 185 ϕ 90
13831		
14121		
[28]	*	30 ml probówka z pokrywką (25 x 94mm), Sterilin® 30 ml tube with cap (25 x 94 mm), Sterilin®
[28]	*	30 ml probówka z pokrywką (25 x 94 mm), Sterilin® 30 ml tube with cap (25 x 94 mm), Sterilin®
14837		
[64]	15046	14 ml probówka z pokrywką (16,8 x 113,7 mm), Sarstedt® 14 ml tube with cap (16,8 x 113,7 mm), Sarstedt®
[64]	*	BD Vacutainer® (16 x 100 mm), (2,5-11 ml)
[64]	*	Greiner Vacuette® (16 x 100 mm), (7-9 ml)
[64]	*	Sarstedt S-Monovette® (15 x 75 mm), (4; 4,3; 5,5 ml)
[64]	*	Sarstedt S-Monovette® (15 x 92 mm), (7,5; 8,2; 8,5 ml)
[64]	*	Sarstedt S-Monovette® (16 x 92 mm), (9; 10 ml)
[64]	*	10 ml Thermo Nalgene® Oak Ridge (16 x 81,5 mm)
[64]	15118	10 ml probówka szklana (16 x 100 mm) 10 ml glass tube (16 x 100 mm)
[64]	*	15 ml Thermo Nalgene® (16 x 113 mm) 15 ml Thermo Nalgene® (16 x 113 mm)
[64]	*	10 ml probówka z pokrywką (16 x 106 mm) 10 ml tube with cap (16 x 106 mm)
14838		
[48]	*	15 ml probówka z dnem stożkowym z zakrętką (17 x 120 mm), Falcon®; [15050], 15ml (17 x 120 mm) 15 ml tube, conical bottom, with cap (17 x 120 mm), Falcon®; [15050] 15ml Sarstedt®(17 x 120
14839		
[32]	15055	30 ml probówka z pokrywką (25,4 x 103,2 mm) 30 ml tube with cap (25,4 x 103,2 mm)
[32]	*	28 ml Thermo Nalgene® Oak Ridge (25,4 x 101,8 mm)
[32]	*	30 ml probówka z pokrywką (25,5 x 94 mm), Nalgene® 30 ml tube with cap (25,5 x 94 mm), Nalgene®
[32]	*	30 ml Thermo Nalgene® Oak Ridge (25,5 x 94,3 mm) 30 ml Thermo Nalgene® Oak Ridge (25,5 x 94,3 mm)

A. Wyposażenie dodatkowe/Optional accessories
MPW-380/R

[32]	*	25 ml probówka szklana (25 x 100 mm) 25 ml glass tube (25 x 100 mm) 14840
[20]	*	50 ml probówka z dnem stożkowym z zakrętką (30 x 117 mm), Falcon®; [15052] 50ml (30 x 117mm) 50 ml tube, conical bottom, with cap (30 x 117 mm), Falcon®; [15052] 50ml Sarstedt® (30 x 117
[20]	*	50 ml probówka z dnem stożkowym bez rantu (30 x 115 mm), Greiner® 50 ml tube, conical bottom, without skirt (30 x 115 mm), Greiner® 14841
[8]	15040	100 ml probówka z pokrywką (45,2 x 103,7 mm) 100 ml tube with cap (45,2 x 103,7 mm)
[8]	*	100 ml probówka szklana (44 x 100 mm) 100 ml glass tube (44 x 100 mm) 14844
[104]	*	2-1,5 ml probówka (10,8x41,8 mm), Eppendorf®; [15011], 2 ml (10,8x41,8 mm); [15128], 1,5ml (10,8x40,5 mm)
[104]	*	2 ml probówki z filtrem - spin columns (10,8 x 46 mm) 2 ml spin columns (with filter) (10,8 x 46 mm); [15011], 2 ml (10,8x41,8 mm); [15128], 1,5ml 14860
[112]	*	Sarstedt S-Monovette® (8 x 66 mm), (1,1; 1,2; 1,4 ml) Sarstedt S-Monovette® (8 x 66 mm), (1,1; 1,2; 1,4 ml) 14862
[100]	*	Sarstedt S-Monovette® (11 x 66 mm), (1,6; 2; 2,7; 3; 3,1 ml)
[100]	*	Sarstedt S-Monovette® (11 x 92 mm), (4,5; 5 ml)
[100]	*	7 ml probówka szklana (12 x 100 mm) 7 ml glass tube (12 x 100 mm)
[100]	*	5 ml probówka szklana (12 x 75 mm) 5 ml glass tube (12 x 75 mm)
[100]	*	5 ml probówka z korkiem (12 x 85 mm), Sarstedt® 5 ml tube with cap (12 x 85 mm), Sarstedt®
[100]	*	6 ml probówka z pokrywką (11,5 x 92 mm), Sarstedt® 6 ml tube with cap (11,5 x 92 mm), Sarstedt® 14863
[96]	*	BD Vacutainer® (13 x 75 mm), (1,6-5,3 ml)
[96]	*	BD Vacutainer® (13 x 100 mm), (4-7 ml)
[96]	*	Greiner Vacuette® (13 x 75 mm), (1-4,5 ml)
[96]	*	Greiner Vacuette® (13 x 100 mm), (3,5-6 ml)
[96]	*	Sarstedt S-Monovette® (13 x 75 mm), (2,7; 3; 4,3 ml)
[96]	*	Sarstedt S-Monovette® (11 x 92 mm), (4,5; 5 ml)
[96]	*	Sarstedt S-Monovette® (13 x 65 mm), (2,6; 2,9; 3,4; 3,8 ml)
[96]	*	Sarstedt S-Monovette® (13 x 90 mm), (4,9; 5,6 ml)
[96]	*	5 ml probówka szklana (12 x 75 mm) 5 ml glass tube (12 x 75 mm)
[96]	*	5 ml probówka z korkiem (12 x 85 mm), Sarstedt® 5 ml tube with cap (12 x 85 mm), Sarstedt®
[96]	*	6 ml probówka z pokrywką (11,5 x 92 mm), Sarstedt® 6 ml tube with cap (11,5 x 92 mm), Sarstedt® 14842+14017
[4]	*	250 ml butelka okrągłodenna (62 x 122 mm), Herolab® nr 25 34 43 250 ml round-bottom bottle (62 x 122 mm), Herolab® no. 25 34 43 14842+14175
[4]	15175	250 ml butelka płaskodenna (62 x 122 mm), Herolab® nr 25 34 21 250 ml bottle, flat bottom (62 x 122 mm), Herolab® no. 25 34 21
[4]	15176	250 ml butelka płaskodenna (62 x 122 mm), Herolab® nr 25 34 01 250 ml bottle, flat bottom (62 x 122 mm), Herolab® no. 25 34 01
13831+17832		
14121		
[28]	*	30 ml probówka z pokrywką (25 x 94mm), Sterilin® 30 ml tube with cap (25 x 94 mm), Sterilin®
[28]	*	30 ml probówka z pokrywką (25 x 94 mm), Sterilin® 30 ml tube with cap (25 x 94 mm), Sterilin® 14837
[64]	15046	14 ml probówka z pokrywką (16,8 x 113,7 mm), Sarstedt® 14 ml tube with cap (16,8 x 113,7 mm), Sarstedt®
[64]	*	BD Vacutainer® (16 x 100 mm), (2,5-11 ml)
[64]	*	Greiner Vacuette® (16 x 100 mm), (7-9 ml)
[64]	*	Sarstedt S-Monovette® (15 x 75 mm), (4; 4,3; 5,5 ml)
[64]	*	Sarstedt S-Monovette® (15 x 92 mm), (7,5; 8,2; 8,5 ml)
[64]	*	Sarstedt S-Monovette® (16 x 92 mm), (9; 10 ml)
[64]	*	10 ml Thermo Nalgene® Oak Ridge (16 x 81,5 mm)

A. Wyposażenie dodatkowe/Optional accessories
MPW-380/R

[64]	15118	10 ml probówka szklana (16 x 100 mm) 10 ml glass tube (16 x 100 mm)
[64]	*	15 ml Thermo Nalgene® (16 x 113 mm) 15 ml Thermo Nalgene® (16 x 113 mm)
[64]	*	10 ml probówka z pokrywką (16 x 106 mm) 10 ml tube with cap (16 x 106 mm)
14838		
[48]	*	15 ml probówka z dnem stożkowym z zakrętką (17 x 120 mm), Falcon®; [15050], 15ml (17 x 120 mm) 15 ml tube, conical bottom, with cap (17 x 120 mm), Falcon®; [15050] 15ml Sarstedt®(17 x 120
14839		
[32]	15055	30 ml probówka z pokrywką (25,4 x 103,2 mm) 30 ml tube with cap (25,4 x 103,2 mm)
[32]	*	28 ml Thermo Nalgene® Oak Ridge (25,4 x 101,8 mm)
[32]	*	30 ml probówka z pokrywką (25,5 x 94 mm), Nalgene® 30 ml tube with cap (25,5 x 94 mm), Nalgene®
[32]	*	30 ml Thermo Nalgene® Oak Ridge (25,5 x 94,3 mm) 30 ml Thermo Nalgene® Oak Ridge (25,5 x 94,3 mm)
[32]	*	25 ml probówka szklana (25 x 100 mm) 25 ml glass tube (25 x 100 mm)
14840		
[20]	*	50 ml probówka z dnem stożkowym z zakrętką (30 x 117 mm), Falcon®; [15052] 50ml (30 x 117mm) 50 ml tube, conical bottom, with cap (30 x 117 mm), Falcon®; [15052] 50ml Sarstedt® (30 x 117
[20]	*	50 ml probówka z dnem stożkowym bez rantu (30 x 115 mm), Greiner® 50 ml tube, conical bottom, without skirt (30 x 115 mm), Greiner®
14841		
[8]	15040	100 ml probówka z pokrywką (45,2 x 103,7 mm) 100 ml tube with cap (45,2 x 103,7 mm)
[8]	*	100 ml probówka szklana (44 x 100 mm) 100 ml glass tube (44 x 100 mm)
14844		
[104]	*	2-1,5 ml probówka (10,8x41,8 mm), Eppendorf®; [15011], 2 ml (10,8x41,8 mm); [15128], 1,5ml (10,8x40,5 mm)
[104]	*	2 ml probówki z filtrem - spin columns (10,8 x 46 mm) 2 ml spin columns (with filter) (10,8 x 46 mm); [15011], 2 ml (10,8x41,8 mm); [15128], 1,5ml
14860		
[112]	*	Sarstedt S-Monovette® (8 x 66 mm), (1,1; 1,2; 1,4 ml) Sarstedt S-Monovette® (8 x 66 mm), (1,1; 1,2; 1,4 ml)
14862		
[100]	*	Sarstedt S-Monovette® (11 x 66 mm), (1,6; 2; 2,7; 3; 3,1 ml)
[100]	*	Sarstedt S-Monovette® (11 x 92 mm), (4,5; 5 ml)
[100]	*	7 ml probówka szklana (12 x 100 mm) 7 ml glass tube (12 x 100 mm)
[100]	*	5 ml probówka szklana (12 x 75 mm) 5 ml glass tube (12 x 75 mm)
[100]	*	5 ml probówka z korkiem (12 x 85 mm), Sarstedt® 5 ml tube with cap (12 x 85 mm), Sarstedt®
[100]	*	6 ml probówka z pokrywką (11,5 x 92 mm), Sarstedt® 6 ml tube with cap (11,5 x 92 mm), Sarstedt®
14863		
[96]	*	BD Vacutainer® (13 x 75 mm), (1,6-5,3 ml)
[96]	*	BD Vacutainer® (13 x 100 mm), (4-7 ml)
[96]	*	Greiner Vacuette® (13 x 75 mm), (1-4,5 ml)
[96]	*	Greiner Vacuette® (13 x 100 mm), (3,5-6 ml)
[96]	*	Sarstedt S-Monovette® (13 x 75 mm), (2,7; 3; 4,3 ml)
[96]	*	Sarstedt S-Monovette® (11 x 92 mm), (4,5; 5 ml)
[96]	*	Sarstedt S-Monovette® (13 x 65 mm), (2,6; 2,9; 3,4; 3,8 ml)
[96]	*	Sarstedt S-Monovette® (13 x 90 mm), (4,9; 5,6 ml)
[96]	*	5 ml probówka szklana (12 x 75 mm) 5 ml glass tube (12 x 75 mm)
[96]	*	5 ml probówka z korkiem (12 x 85 mm), Sarstedt® 5 ml tube with cap (12 x 85 mm), Sarstedt®
[96]	*	6 ml probówka z pokrywką (11,5 x 92 mm), Sarstedt® 6 ml tube with cap (11,5 x 92 mm), Sarstedt®
14842+14017		
[4]	*	250 ml butelka okrągłodenna (62 x 122 mm), Herolab® nr 25 34 43 250 ml round-bottom bottle (62 x 122 mm), Herolab® no. 25 34 43
14842+14175		
[4]	15175	250 ml butelka płaskodenna (62 x 122 mm), Herolab® nr 25 34 21 250 ml bottle, flat bottom (62 x 122 mm), Herolab® no. 25 34 21
[4]	15176	250 ml butelka płaskodenna (62 x 122 mm), Herolab® nr 25 34 01 250 ml bottle, flat bottom (62 x 122 mm), Herolab® no. 25 34 01

* probówka niedostępna w ofercie MPW lub dostępny odpowiednik (np.[15050]), patrz kolumna z prawej
tube is not offered by MPW or equivalent is available (e.g. [15050]), see column on the right

A. Wyposażenie dodatkowe/Optional accessories
MPW-380/R
13833+17834
14851+14175

- [4] 15175 250 ml butelka płaskodenna (62 x 122 mm), Herolab® nr 25 34 21
250 ml bottle, flat bottom (62 x 122 mm), Herolab® no. 25 34 21
- [4] 15176 250 ml butelka płaskodenna (62 x 122 mm), Herolab® nr 25 34 01
250 ml bottle, flat bottom (62 x 122 mm), Herolab® no. 25 34 01

13833 R max 184 RCF 3291
14845 Rmax 184 RCF 3291

- [72] * BD Vacutainer® (13 x 75 mm), (1,6-5,3 ml)
- [72] * BD Vacutainer® (13 x 100 mm), (4-7 ml)
- [72] * Greiner Vacuette® (13 x 75 mm), (1-4,5 ml)
- [72] * Greiner Vacuette® (13 x 100 mm), (3,5-6 ml)
- [72] * Sarstedt S-Monovette® (11 x 66 mm), (1,6; 2; 2,7; 3; 3,1 ml)
- [72] * Sarstedt S-Monovette® (13 x 65 mm), (2,6; 2,9; 3,4; 3,8 ml)
- [72] * Sarstedt S-Monovette® (13 x 75 mm), (2,7; 3; 4,3 ml)
- [72] * Sarstedt S-Monovette® (11 x 92 mm), (4,5; 5 ml)
- [72] * Sarstedt S-Monovette® (13 x 90 mm), (4,9; 5,6 ml)
- [72] * 5 ml probówka szklana (12 x 75 mm)
5 ml glass tube (12 x 75 mm)
- [72] * 5 ml probówka z korkiem (12 x 85 mm), Sarstedt®
5 ml tube with cap (12 x 85 mm), Sarstedt®
- [72] * 7 ml probówka szklana (12 x 100 mm)
7 ml glass tube (12 x 100 mm)
- [72] * 6 ml probówka z pokrywką (11,5 x 92 mm), Sarstedt®
6 ml tube with cap (11,5 x 92 mm), Sarstedt®

14846 Rmax 184 RCF 3291

- [48] 15046 14 ml probówka z pokrywką (16,8 x 113,7 mm), Sarstedt®
14 ml tube with cap (16,8 x 113,7 mm), Sarstedt®
- [48] * BD Vacutainer® (16 x 100 mm), (2,5-11 ml)
- [48] * Greiner Vacuette® (16 x 100 mm), (7-9 ml)
- [48] * Sarstedt S-Monovette® (15 x 92 mm), (7,5; 8,2; 8,5 ml)
- [48] * 10 ml Thermo Nalgene® Oak Ridge (16 x 81,5 mm)
- [48] 15118 10 ml probówka szklana (16 x 100 mm)
10 ml glass tube (16 x 100 mm)
- [48] * 10 ml probówka z pokrywką (16 x 106 mm)
10 ml tube with cap (16 x 106 mm)

14848 Rmax 184 RCF 3291

- [20] 15055 30 ml probówka z pokrywką (25,4 x 103,2 mm)
30 ml tube with cap (25,4 x 103,2 mm)
- [20] * 28 ml Thermo Nalgene® Oak Ridge (25,4 x 101,8 mm)
- [20] * 30 ml Thermo Nalgene® Oak Ridge (25,5 x 94,3 mm)
- [20] * 30 ml Thermo Nalgene® Oak Ridge (25,5 x 94,3 mm)
- [20] * 25 ml probówka szklana (25 x 100 mm)
25 ml glass tube (25 x 100 mm)

14849 Rmax 184 RCF 3291

- [16] * 50 ml probówka z dnem stożkowym z zakrętką (30 x 117 mm), Falcon®; [15052] 50ml (30 x 117mm)
50 ml tube, conical bottom, with cap (30 x 117 mm), Falcon®; [15052] 50ml Sarstedt® (30 x 117
- [16] * 50 ml probówka z dnem stożkowym bez rantu (30 x 115 mm), Greiner®
50 ml tube, conical bottom, without skirt (30 x 115 mm), Greiner®

14850 Rmax 184 RCF 3291

- [4] 15040 100 ml probówka z pokrywką (45,2 x 103,7 mm)
100 ml tube with cap (45,2 x 103,7 mm)
- [4] * 100 ml probówka szklana (44 x 100 mm)
100 ml glass tube (44 x 100 mm)

14853 Rmax 184 RCF 3291

- [84] * 2-1,5 ml probówka (10,8x41,8 mm), Eppendorf®; [15011], 2 ml (10,8x41,8 mm); [15128], 1,5ml
(10,8x40,5 mm)
- [84] * 2 ml probówki z filtrem - spin columns (10,8 x 46 mm)
2 ml spin columns (with filter) (10,8 x 46 mm); [15011], 2 ml (10,8x41,8 mm); [15128], 1,5ml

14854 Rmax 184 RCF 3291

- [4] 15440 200 ml butelka płaskodenna (56 x 112 mm), Herolab® nr 25 33 73
200 ml bottle, flat bottom (56 x 112 mm), Herolab® no. 25 33 73

14861 Rmax 184 RCF 3291

- [96] * Sarstedt S-Monovette® (8 x 66 mm), (1,1; 1,2; 1,4 ml)
Sarstedt S-Monovette® (8 x 66 mm), (1,1; 1,2; 1,4 ml)

14867 Rmax 184 RCF 3291

- [36] * 15 ml probówka z dnem stożkowym z zakrętką (17 x 120 mm), Falcon®; [15050], 15ml (17 x 120 mm)
15 ml tube, conical bottom, with cap (17 x 120 mm), Falcon®; [15050] 15ml Sarstedt®(17 x 120
bez wkładki/without adapter Rmax 184 RCF 3291

A. Wyposażenie dodatkowe/Optional accessories
MPW-380/R

[4]	15852	500 ml butelka (84 x 135 mm), Herolab® nr 25 36 11 500 ml bottle (84 x 135 mm), Herolab® no. 25 36 11 14851+14017 Rmax 184 RCF 3291
[4]	*	250 ml butelka okrągłodenna (62 x 122 mm), Herolab® nr 25 34 43 250 ml round-bottom bottle (62 x 122 mm), Herolab® no. 25 34 43 14851+14175 Rmax 184 RCF 3291
[4]	15175	250 ml butelka płaskodenna (62 x 122 mm), Herolab® nr 25 34 21 250 ml bottle, flat bottom (62 x 122 mm), Herolab® no. 25 34 21
[4]	15176	250 ml butelka płaskodenna (62 x 122 mm), Herolab® nr 25 34 01 250 ml bottle, flat bottom (62 x 122 mm), Herolab® no. 25 34 01 14847 Rmax 184 RCF 3291
[48]	15050	15 ml probówka z dnem stożkowym z zakrętką (17 x 120 mm), Sarstedt® 15 ml tube, conical bottom, with cap (17 x 120 mm), Sarstedt® 14859 Rmax 184 RCF 3291
[12]	*	50 ml probówka szklana (35 x 100 mm) 50 ml glass tube (35 x 100 mm) 14850+14159 Rmax 184 RCF 3291
[4]	*	50 ml probówka szklana (35 x 100 mm) 50 ml glass tube (35 x 100 mm)
		13865 R max 183 RCF 3274 14043 Rmax 183 RCF 3274
[28]	*	Greiner Vacuette® (13 x 75 mm), (1-4,5 ml)
[28]	*	5 ml probówka szklana (12 x 75 mm) 5 ml glass tube (12 x 75 mm)
[28]	*	5 ml probówka z korkiem (12 x 85 mm), Sarstedt® 5 ml tube with cap (12 x 85 mm), Sarstedt® 14071 Rmax 183 RCF 3274
[28]	15055	30 ml probówka z pokrywką (25,4 x 103,2 mm) 30 ml tube with cap (25,4 x 103,2 mm)
[28]	*	28 ml Thermo Nalgene® Oak Ridge (25,4 x 101,8 mm)
[28]	*	30 ml probówka z pokrywką (25,5 x 94 mm), Nalgene® 30 ml tube with cap (25,5 x 94 mm), Nalgene®
[28]	*	30 ml Thermo Nalgene® Oak Ridge (25,5 x 94,3 mm) 30 ml Thermo Nalgene® Oak Ridge (25,5 x 94,3 mm)
[28]	*	25 ml probówka szklana (25 x 100 mm) 25 ml glass tube (25 x 100 mm) 14073 Rmax 183 RCF 3274
[28]	*	BD Vacutainer® (16 x 100 mm), (2,5-11 ml)
[28]	*	Greiner Vacuette® (16 x 100 mm), (7-9 ml)
[28]	*	Sarstedt S-Monovette® (15 x 92 mm), (7,5; 8,2; 8,5 ml)
[28]	15046	14 ml probówka z pokrywką (16,8 x 113,7 mm), Sarstedt® 14 ml tube with cap (16,8 x 113,7 mm), Sarstedt®
[28]	*	Sarstedt S-Monovette® (16 x 92 mm), (9; 10 ml)
[28]	15118	10 ml probówka szklana (16 x 100 mm) 10 ml glass tube (16 x 100 mm)
[28]	*	15 ml Thermo Nalgene® (16 x 113 mm) 15 ml Thermo Nalgene® (16 x 113 mm)
[28]	*	10 ml probówka z pokrywką (16 x 106 mm) 10 ml tube with cap (16 x 106 mm) 14089 Rmax 183 RCF 3274
[4]	*	15 ml probówka z dnem stożkowym z zakrętką (17 x 120 mm), Falcon®; [15050], 15ml (17 x 120 mm) 15 ml tube, conical bottom, with cap (17 x 120 mm), Falcon®; [15050] 15ml Sarstedt®(17 x 120 mm) bez wkładki/without adapter Rmax 183 RCF 3274
[28]	*	50 ml probówka z dnem stożkowym z zakrętką (30 x 117 mm), Falcon®; [15052] 50ml (30 x 117mm) 50 ml tube, conical bottom, with cap (30 x 117 mm), Falcon®; [15052] 50ml Sarstedt® (30 x 117
[28]	*	50 ml probówka z dnem stożkowym bez rantu (30 x 115 mm), Greiner® 50 ml tube, conical bottom, without skirt (30 x 115 mm), Greiner®
		13866 R max 186 RCF 3327 14043 Rmax 186 RCF 3327
[24]	*	Greiner Vacuette® (13 x 75 mm), (1-4,5 ml)
[24]	*	5 ml probówka szklana (12 x 75 mm) 5 ml glass tube (12 x 75 mm)
[24]	*	5 ml probówka z korkiem (12 x 85 mm), Sarstedt® 5 ml tube with cap (12 x 85 mm), Sarstedt® 14071 Rmax 186 RCF 3327
[24]	15055	30 ml probówka z pokrywką (25,4 x 103,2 mm) 30 ml tube with cap (25,4 x 103,2 mm)
[24]	*	28 ml Thermo Nalgene® Oak Ridge (25,4 x 101,8 mm)

A. Wyposażenie dodatkowe/Optional accessories
MPW-380/R

[24]	*	30 ml probówka z pokrywką (25,5 x 94 mm), Nalgene® 30 ml tube with cap (25,5 x 94 mm), Nalgene®
[24]	*	30 ml Thermo Nalgene® Oak Ridge (25,5 x 94,3 mm) 30 ml Thermo Nalgene® Oak Ridge (25,5 x 94,3 mm)
[24]	*	25 ml probówka szklana (25 x 100 mm) 25 ml glass tube (25 x 100 mm)
		14073 Rmax 186 RCF 3327
[24]	15046	14 ml probówka z pokrywką (16,8 x 113,7 mm), Sarstedt® 14 ml tube with cap (16,8 x 113,7 mm), Sarstedt®
[24]	*	BD Vacutainer® (16 x 100 mm), (2,5-11 ml)
[24]	*	Greiner Vacuette® (16 x 100 mm), (7-9 ml)
[24]	*	Sarstedt S-Monovette® (15 x 92 mm), (7,5; 8,2; 8,5 ml)
[24]	*	Sarstedt S-Monovette® (16 x 92 mm), (9; 10 ml)
[24]	15118	10 ml probówka szklana (16 x 100 mm) 10 ml glass tube (16 x 100 mm)
[24]	*	15 ml Thermo Nalgene® (16 x 113 mm) 15 ml Thermo Nalgene® (16 x 113 mm)
[24]	*	10 ml probówka z pokrywką (16 x 106 mm) 10 ml tube with cap (16 x 106 mm)
		14089 Rmax 186 RCF 3327
[4]	*	15 ml probówka z dnem stożkowym z zakrętką (17 x 120 mm), Falcon®; [15050], 15ml (17 x 120 mm) 15 ml tube, conical bottom, with cap (17 x 120 mm), Falcon®; [15050] 15ml Sarstedt®(17 x 120 mm) bez wkładki/without adapter Rmax 186 RCF 3327
[24]	*	50 ml probówka z dnem stożkowym z zakrętką (30 x 117 mm), Falcon®; [15052] 50ml (30 x 117mm) 50 ml tube, conical bottom, with cap (30 x 117 mm), Falcon®; [15052] 50ml Sarstedt® (30 x 117
[24]	*	50 ml probówka z dnem stożkowym bez rantu (30 x 115 mm), Greiner® 50 ml tube, conical bottom, without skirt (30 x 115 mm), Greiner®
		13833+17834 R max 184 RCF 3291
		14845 Rmax 184 RCF 3291
[72]	*	BD Vacutainer® (13 x 75 mm), (1,6-5,3 ml)
[72]	*	BD Vacutainer® (13 x 100 mm), (4-7 ml)
[72]	*	Greiner Vacuette® (13 x 75 mm), (1-4,5 ml)
[72]	*	Greiner Vacuette® (13 x 100 mm), (3,5-6 ml)
[72]	*	Sarstedt S-Monovette® (11 x 66 mm), (1,6; 2; 2,7; 3; 3,1 ml)
[72]	*	Sarstedt S-Monovette® (13 x 65 mm), (2,6; 2,9; 3,4; 3,8 ml)
[72]	*	Sarstedt S-Monovette® (13 x 75 mm), (2,7; 3; 4,3 ml)
[72]	*	Sarstedt S-Monovette® (11 x 92 mm), (4,5; 5 ml)
[72]	*	Sarstedt S-Monovette® (13 x 90 mm), (4,9; 5,6 ml)
[72]	*	5 ml probówka szklana (12 x 75 mm) 5 ml glass tube (12 x 75 mm)
[72]	*	5 ml probówka z korkiem (12 x 85 mm), Sarstedt® 5 ml tube with cap (12 x 85 mm), Sarstedt®
[72]	*	7 ml probówka szklana (12 x 100 mm) 7 ml glass tube (12 x 100 mm)
[72]	*	6 ml probówka z pokrywką (11,5 x 92 mm), Sarstedt® 6 ml tube with cap (11,5 x 92 mm), Sarstedt®
		14846 Rmax 184 RCF 3291
[48]	15046	14 ml probówka z pokrywką (16,8 x 113,7 mm), Sarstedt® 14 ml tube with cap (16,8 x 113,7 mm), Sarstedt®
[48]	*	BD Vacutainer® (16 x 100 mm), (2,5-11 ml)
[48]	*	Greiner Vacuette® (16 x 100 mm), (7-9 ml)
[48]	*	Sarstedt S-Monovette® (15 x 92 mm), (7,5; 8,2; 8,5 ml)
[48]	*	10 ml Thermo Nalgene® Oak Ridge (16 x 81,5 mm)
[48]	15118	10 ml probówka szklana (16 x 100 mm) 10 ml glass tube (16 x 100 mm)
[48]	*	10 ml probówka z pokrywką (16 x 106 mm) 10 ml tube with cap (16 x 106 mm)
		14848 Rmax 184 RCF 3291
[20]	15055	30 ml probówka z pokrywką (25,4 x 103,2 mm) 30 ml tube with cap (25,4 x 103,2 mm)
[20]	*	28 ml Thermo Nalgene® Oak Ridge (25,4 x 101,8 mm)
[20]	*	30 ml Thermo Nalgene® Oak Ridge (25,5 x 94,3 mm) 30 ml Thermo Nalgene® Oak Ridge (25,5 x 94,3 mm)
[20]	*	25 ml probówka szklana (25 x 100 mm) 25 ml glass tube (25 x 100 mm)
		14849 Rmax 184 RCF 3291
[16]	*	50 ml probówka z dnem stożkowym z zakrętką (30 x 117 mm), Falcon®; [15052] 50ml (30 x 117mm) 50 ml tube, conical bottom, with cap (30 x 117 mm), Falcon®; [15052] 50ml Sarstedt® (30 x 117
[16]	*	50 ml probówka z dnem stożkowym bez rantu (30 x 115 mm), Greiner® 50 ml tube, conical bottom, without skirt (30 x 115 mm), Greiner®

A. Wyposażenie dodatkowe/Optional accessories
MPW-380/R

		14850 Rmax 184 RCF 3291
[4]	15040	100 ml probówka z pokrywką (45,2 x 103,7 mm) 100 ml tube with cap (45,2 x 103,7 mm)
[4]	*	100 ml probówka szklana (44 x 100 mm) 100 ml glass tube (44 x 100 mm)
		14853 Rmax 184 RCF 3291
[84]	*	2-1,5 ml probówka (10,8x41,8 mm), Eppendorf®; [15011], 2 ml (10,8x41,8 mm); [15128], 1,5ml (10,8x40,5 mm)
[84]	*	2 ml probówki z filtrem - spin columns (10,8 x 46 mm) 2 ml spin columns (with filter) (10,8 x 46 mm); [15011], 2 ml (10,8x41,8 mm); [15128], 1,5ml
		14854 Rmax 184 RCF 3291
[4]	15440	200 ml butelka płaskodenna (56 x 112 mm), Herolab® nr 25 33 73 200 ml bottle, flat bottom (56 x 112 mm), Herolab® no. 25 33 73
		14861 Rmax 184 RCF 3291
[96]	*	Sarstedt S-Monovette® (8 x 66 mm), (1,1; 1,2; 1,4 ml) Sarstedt S-Monovette® (8 x 66 mm), (1,1; 1,2; 1,4 ml)
		14867 Rmax 184 RCF 3291
[36]	*	15 ml probówka z dnem stożkowym z zakrętką (17 x 120 mm), Falcon®; [15050], 15ml (17 x 120 mm) 15 ml tube, conical bottom, with cap (17 x 120 mm), Falcon®; [15050] 15ml Sarstedt®(17 x 120 bez wkładki/without adapter Rmax 184 RCF 3291
[4]	15852	500 ml butelka (84 x 135 mm), Herolab® nr 25 36 11 500 ml bottle (84 x 135 mm), Herolab® no. 25 36 11
		14851+14017 Rmax 184 RCF 3291
[4]	*	250 ml butelka okrągłodenna (62 x 122 mm), Herolab® nr 25 34 43 250 ml round-bottom bottle (62 x 122 mm), Herolab® no. 25 34 43
		14847 Rmax 184 RCF 3291
[48]	15050	15 ml probówka z dnem stożkowym z zakrętką (17 x 120 mm), Sarstedt® 15 ml tube, conical bottom, with cap (17 x 120 mm), Sarstedt®
		14859 Rmax 184 RCF 3291
[12]	*	50 ml probówka szklana (35 x 100 mm) 50 ml glass tube (35 x 100 mm)
		14850+14159 Rmax 184 RCF 3291
[4]	*	50 ml probówka szklana (35 x 100 mm) 50 ml glass tube (35 x 100 mm)
12870		
		RPM 4300 RCF 3824 Rmax 185 4 90
13831		
		14121
[28]	*	30 ml probówka z pokrywką (25 x 94mm), Sterilin® 30 ml tube with cap (25 x 94 mm), Sterilin®
[28]	*	30 ml probówka z pokrywką (25 x 94 mm), Sterilin® 30 ml tube with cap (25 x 94 mm), Sterilin®
		14837
[64]	15046	14 ml probówka z pokrywką (16,8 x 113,7 mm), Sarstedt® 14 ml tube with cap (16,8 x 113,7 mm), Sarstedt®
[64]	*	BD Vacutainer® (16 x 100 mm), (2,5-11 ml)
[64]	*	Greiner Vacuette® (16 x 100 mm), (7-9 ml)
[64]	*	Sarstedt S-Monovette® (15 x 75 mm), (4; 4,3; 5,5 ml)
[64]	*	Sarstedt S-Monovette® (15 x 92 mm), (7,5; 8,2; 8,5 ml)
[64]	*	Sarstedt S-Monovette® (16 x 92 mm), (9; 10 ml)
[64]	*	10 ml Thermo Nalgene® Oak Ridge (16 x 81,5 mm)
[64]	15118	10 ml probówka szklana (16 x 100 mm) 10 ml glass tube (16 x 100 mm)
[64]	*	15 ml Thermo Nalgene® (16 x 113 mm) 15 ml Thermo Nalgene® (16 x 113 mm)
[64]	*	10 ml probówka z pokrywką (16 x 106 mm) 10 ml tube with cap (16 x 106 mm)
		14838
[48]	*	15 ml probówka z dnem stożkowym z zakrętką (17 x 120 mm), Falcon®; [15050], 15ml (17 x 120 mm) 15 ml tube, conical bottom, with cap (17 x 120 mm), Falcon®; [15050] 15ml Sarstedt®(17 x 120
		14839
[32]	15055	30 ml probówka z pokrywką (25,4 x 103,2 mm) 30 ml tube with cap (25,4 x 103,2 mm)
[32]	*	28 ml Thermo Nalgene® Oak Ridge (25,4 x 101,8 mm)
[32]	*	30 ml probówka z pokrywką (25,5 x 94 mm), Nalgene® 30 ml tube with cap (25,5 x 94 mm), Nalgene®
[32]	*	30 ml Thermo Nalgene® Oak Ridge (25,5 x 94,3 mm) 30 ml Thermo Nalgene® Oak Ridge (25,5 x 94,3 mm)
[32]	*	25 ml probówka szklana (25 x 100 mm) 25 ml glass tube (25 x 100 mm)

* probówka niedostępna w ofercie MPW lub dostępny odpowiednik (np.[15050]), patrz kolumna z prawej
tube is not offered by MPW or equivalent is available (e.g. [15050]), see column on the right

A. Wyposażenie dodatkowe/Optional accessories
MPW-380/R
14840

- [20] * 50 ml probówka z dnem stożkowym z zakrętką (30 x 117 mm), Falcon®; [15052] 50ml (30 x 117mm)
50 ml tube, conical bottom, with cap (30 x 117 mm), Falcon®; [15052] 50ml Sarstedt® (30 x 117)
- [20] * 50 ml probówka z dnem stożkowym bez rantu (30 x 115 mm), Greiner®
50 ml tube, conical bottom, without skirt (30 x 115 mm), Greiner®

14841

- [8] 15040 100 ml probówka z pokrywką (45,2 x 103,7 mm)
100 ml tube with cap (45,2 x 103,7 mm)
- [8] * 100 ml probówka szklana (44 x 100 mm)
100 ml glass tube (44 x 100 mm)

14844

- [104] * 2-1,5 ml probówka (10,8x41,8 mm), Eppendorf®; [15011], 2 ml (10,8x41,8 mm); [15128], 1,5ml
(10,8x40,5 mm)
- [104] * 2 ml probówki z filtrem - spin columns (10,8 x 46 mm)
2 ml spin columns (with filter) (10,8 x 46 mm); [15011], 2 ml (10,8x41,8 mm); [15128], 1,5ml

14860

- [112] * Sarstedt S-Monovette® (8 x 66 mm), (1,1; 1,2; 1,4 ml)
Sarstedt S-Monovette® (8 x 66 mm), (1,1; 1,2; 1,4 ml)

14862

- [100] * Sarstedt S-Monovette® (11 x 66 mm), (1,6; 2; 2,7; 3; 3,1 ml)
- [100] * Sarstedt S-Monovette® (11 x 92 mm), (4,5; 5 ml)
- [100] * 7 ml probówka szklana (12 x 100 mm)
7 ml glass tube (12 x 100 mm)
- [100] * 5 ml probówka szklana (12 x 75 mm)
5 ml glass tube (12 x 75 mm)
- [100] * 5 ml probówka z korkiem (12 x 85 mm), Sarstedt®
5 ml tube with cap (12 x 85 mm), Sarstedt®
- [100] * 6 ml probówka z pokrywką (11,5 x 92 mm), Sarstedt®
6 ml tube with cap (11,5 x 92 mm), Sarstedt®

14863

- [96] * BD Vacutainer® (13 x 75 mm), (1,6-5,3 ml)
- [96] * BD Vacutainer® (13 x 100 mm), (4-7 ml)
- [96] * Greiner Vacuette® (13 x 75 mm), (1-4,5 ml)
- [96] * Greiner Vacuette® (13 x 100 mm), (3,5-6 ml)
- [96] * Sarstedt S-Monovette® (13 x 75 mm), (2,7; 3; 4,3 ml)
- [96] * Sarstedt S-Monovette® (11 x 92 mm), (4,5; 5 ml)
- [96] * Sarstedt S-Monovette® (13 x 65 mm), (2,6; 2,9; 3,4; 3,8 ml)
- [96] * Sarstedt S-Monovette® (13 x 90 mm), (4,9; 5,6 ml)
- [96] * 5 ml probówka szklana (12 x 75 mm)
5 ml glass tube (12 x 75 mm)
- [96] * 5 ml probówka z korkiem (12 x 85 mm), Sarstedt®
5 ml tube with cap (12 x 85 mm), Sarstedt®
- [96] * 6 ml probówka z pokrywką (11,5 x 92 mm), Sarstedt®
6 ml tube with cap (11,5 x 92 mm), Sarstedt®

14842+14017

- [4] * 250 ml butelka okrągłodenna (62 x 122 mm), Herolab® nr 25 34 43
250 ml round-bottom bottle (62 x 122 mm), Herolab® no. 25 34 43

14842+14175

- [4] 15175 250 ml butelka płaskodenna (62 x 122 mm), Herolab® nr 25 34 21
250 ml bottle, flat bottom (62 x 122 mm), Herolab® no. 25 34 21
- [4] 15176 250 ml butelka płaskodenna (62 x 122 mm), Herolab® nr 25 34 01
250 ml bottle, flat bottom (62 x 122 mm), Herolab® no. 25 34 01

13831+17832
14121

- [28] * 30 ml probówka z pokrywką (25 x 94mm), Sterilin®
30 ml tube with cap (25 x 94 mm), Sterilin®
- [28] * 30 ml probówka z pokrywką (25 x 94 mm), Sterilin®
30 ml tube with cap (25 x 94 mm), Sterilin®

14837

- [64] 15046 14 ml probówka z pokrywką (16,8 x 113,7 mm), Sarstedt®
14 ml tube with cap (16,8 x 113,7 mm), Sarstedt®
- [64] * BD Vacutainer® (16 x 100 mm), (2,5-11 ml)
- [64] * Greiner Vacuette® (16 x 100 mm), (7-9 ml)
- [64] * Sarstedt S-Monovette® (15 x 75 mm), (4; 4,3; 5,5 ml)
- [64] * Sarstedt S-Monovette® (15 x 92 mm), (7,5; 8,2; 8,5 ml)
- [64] * Sarstedt S-Monovette® (16 x 92 mm), (9; 10 ml)
- [64] * 10 ml Thermo Nalgene® Oak Ridge (16 x 81,5 mm)
- [64] 15118 10 ml probówka szklana (16 x 100 mm)
10 ml glass tube (16 x 100 mm)

A. Wyposażenie dodatkowe/Optional accessories
MPW-380/R

[64]	*	15 ml Thermo Nalgene® (16 x 113 mm) 15 ml Thermo Nalgene® (16 x 113 mm)
[64]	*	10 ml probówka z pokrywką (16 x 106 mm) 10 ml tube with cap (16 x 106 mm)
14838		
[48]	*	15 ml probówka z dnem stożkowym z zakrętką (17 x 120 mm), Falcon®; [15050], 15ml (17 x 120 mm) 15 ml tube, conical bottom, with cap (17 x 120 mm), Falcon®; [15050] 15ml Sarstedt®(17 x 120
14839		
[32]	15055	30 ml probówka z pokrywką (25,4 x 103,2 mm) 30 ml tube with cap (25,4 x 103,2 mm)
[32]	*	28 ml Thermo Nalgene® Oak Ridge (25,4 x 101,8 mm)
[32]	*	30 ml probówka z pokrywką (25,5 x 94 mm), Nalgene® 30 ml tube with cap (25,5 x 94 mm), Nalgene®
[32]	*	30 ml Thermo Nalgene® Oak Ridge (25,5 x 94,3 mm) 30 ml Thermo Nalgene® Oak Ridge (25,5 x 94,3 mm)
[32]	*	25 ml probówka szklana (25 x 100 mm) 25 ml glass tube (25 x 100 mm)
14840		
[20]	*	50 ml probówka z dnem stożkowym z zakrętką (30 x 117 mm), Falcon®; [15052] 50ml (30 x 117mm) 50 ml tube, conical bottom, with cap (30 x 117 mm), Falcon®; [15052] 50ml Sarstedt® (30 x 117
[20]	*	50 ml probówka z dnem stożkowym bez rantu (30 x 115 mm), Greiner® 50 ml tube, conical bottom, without skirt (30 x 115 mm), Greiner®
14841		
[8]	15040	100 ml probówka z pokrywką (45,2 x 103,7 mm) 100 ml tube with cap (45,2 x 103,7 mm)
[8]	*	100 ml probówka szklana (44 x 100 mm) 100 ml glass tube (44 x 100 mm)
14844		
[104]	*	2-1,5 ml probówka (10,8x41,8 mm), Eppendorf®; [15011], 2 ml (10,8x41,8 mm); [15128], 1,5ml (10,8x40,5 mm)
[104]	*	2 ml probówki z filtrem - spin columns (10,8 x 46 mm) 2 ml spin columns (with filter) (10,8 x 46 mm); [15011], 2 ml (10,8x41,8 mm); [15128], 1,5ml
14860		
[112]	*	Sarstedt S-Monovette® (8 x 66 mm), (1,1; 1,2; 1,4 ml) Sarstedt S-Monovette® (8 x 66 mm), (1,1; 1,2; 1,4 ml)
14862		
[100]	*	Sarstedt S-Monovette® (11 x 66 mm), (1,6; 2; 2,7; 3; 3,1 ml)
[100]	*	Sarstedt S-Monovette® (11 x 92 mm), (4,5; 5 ml)
[100]	*	7 ml probówka szklana (12 x 100 mm) 7 ml glass tube (12 x 100 mm)
[100]	*	5 ml probówka szklana (12 x 75 mm) 5 ml glass tube (12 x 75 mm)
[100]	*	5 ml probówka z korkiem (12 x 85 mm), Sarstedt® 5 ml tube with cap (12 x 85 mm), Sarstedt®
[100]	*	6 ml probówka z pokrywką (11,5 x 92 mm), Sarstedt® 6 ml tube with cap (11,5 x 92 mm), Sarstedt®
14863		
[96]	*	BD Vacutainer® (13 x 75 mm), (1,6-5,3 ml)
[96]	*	BD Vacutainer® (13 x 100 mm), (4-7 ml)
[96]	*	Greiner Vacuette® (13 x 75 mm), (1-4,5 ml)
[96]	*	Greiner Vacuette® (13 x 100 mm), (3,5-6 ml)
[96]	*	Sarstedt S-Monovette® (13 x 75 mm), (2,7; 3; 4,3 ml)
[96]	*	Sarstedt S-Monovette® (11 x 92 mm), (4,5; 5 ml)
[96]	*	Sarstedt S-Monovette® (13 x 65 mm), (2,6; 2,9; 3,4; 3,8 ml)
[96]	*	Sarstedt S-Monovette® (13 x 90 mm), (4,9; 5,6 ml)
[96]	*	5 ml probówka szklana (12 x 75 mm) 5 ml glass tube (12 x 75 mm)
[96]	*	5 ml probówka z korkiem (12 x 85 mm), Sarstedt® 5 ml tube with cap (12 x 85 mm), Sarstedt®
[96]	*	6 ml probówka z pokrywką (11,5 x 92 mm), Sarstedt® 6 ml tube with cap (11,5 x 92 mm), Sarstedt®
14842+14017		
[4]	*	250 ml butelka okrągłodenna (62 x 122 mm), Herolab® nr 25 34 43 250 ml round-bottom bottle (62 x 122 mm), Herolab® no. 25 34 43
14842+14175		
[4]	15175	250 ml butelka płaskodenna (62 x 122 mm), Herolab® nr 25 34 21 250 ml bottle, flat bottom (62 x 122 mm), Herolab® no. 25 34 21
[4]	15176	250 ml butelka płaskodenna (62 x 122 mm), Herolab® nr 25 34 01 250 ml bottle, flat bottom (62 x 122 mm), Herolab® no. 25 34 01

13833+17834

A. Wyposażenie dodatkowe/Optional accessories
MPW-380/R
14851+14175

[4]	15175	250 ml butelka płaskodenna (62 x 122 mm), Herolab® nr 25 34 21 250 ml bottle, flat bottom (62 x 122 mm), Herolab® no. 25 34 21
[4]	15176	250 ml butelka płaskodenna (62 x 122 mm), Herolab® nr 25 34 01 250 ml bottle, flat bottom (62 x 122 mm), Herolab® no. 25 34 01

13833 R max 184 RCF 3804
14845 Rmax 184 RCF 3804

[72]	*	BD Vacutainer® (13 x 75 mm), (1,6-5,3 ml)
[72]	*	BD Vacutainer® (13 x 100 mm), (4-7 ml)
[72]	*	Greiner Vacuette® (13 x 75 mm), (1-4,5 ml)
[72]	*	Greiner Vacuette® (13 x 100 mm), (3,5-6 ml)
[72]	*	Sarstedt S-Monovette® (11 x 66 mm), (1,6; 2; 2,7; 3; 3,1 ml)
[72]	*	Sarstedt S-Monovette® (13 x 65 mm), (2,6; 2,9; 3,4; 3,8 ml)
[72]	*	Sarstedt S-Monovette® (13 x 75 mm), (2,7; 3; 4,3 ml)
[72]	*	Sarstedt S-Monovette® (11 x 92 mm), (4,5; 5 ml)
[72]	*	Sarstedt S-Monovette® (13 x 90 mm), (4,9; 5,6 ml)
[72]	*	5 ml probówka szklana (12 x 75 mm) 5 ml glass tube (12 x 75 mm)
[72]	*	5 ml probówka z korkiem (12 x 85 mm), Sarstedt® 5 ml tube with cap (12 x 85 mm), Sarstedt®
[72]	*	7 ml probówka szklana (12 x 100 mm) 7 ml glass tube (12 x 100 mm)
[72]	*	6 ml probówka z pokrywką (11,5 x 92 mm), Sarstedt® 6 ml tube with cap (11,5 x 92 mm), Sarstedt®

14846 Rmax 184 RCF 3804

[48]	15046	14 ml probówka z pokrywką (16,8 x 113,7 mm), Sarstedt® 14 ml tube with cap (16,8 x 113,7 mm), Sarstedt®
[48]	*	BD Vacutainer® (16 x 100 mm), (2,5-11 ml)
[48]	*	Greiner Vacuette® (16 x 100 mm), (7-9 ml)
[48]	*	Sarstedt S-Monovette® (15 x 92 mm), (7,5; 8,2; 8,5 ml)
[48]	*	10 ml Thermo Nalgene® Oak Ridge (16 x 81,5 mm)
[48]	15118	10 ml probówka szklana (16 x 100 mm) 10 ml glass tube (16 x 100 mm)
[48]	*	10 ml probówka z pokrywką (16 x 106 mm) 10 ml tube with cap (16 x 106 mm)

14848 Rmax 184 RCF 3804

[20]	15055	30 ml probówka z pokrywką (25,4 x 103,2 mm) 30 ml tube with cap (25,4 x 103,2 mm)
[20]	*	28 ml Thermo Nalgene® Oak Ridge (25,4 x 101,8 mm)
[20]	*	30 ml Thermo Nalgene® Oak Ridge (25,5 x 94,3 mm) 30 ml Thermo Nalgene® Oak Ridge (25,5 x 94,3 mm)
[20]	*	25 ml probówka szklana (25 x 100 mm) 25 ml glass tube (25 x 100 mm)

14849 Rmax 184 RCF 3804

[16]	*	50 ml probówka z dnem stożkowym z zakrętką (30 x 117 mm), Falcon®; [15052] 50ml (30 x 117mm) 50 ml tube, conical bottom, with cap (30 x 117 mm), Falcon®; [15052] 50ml Sarstedt® (30 x 117)
[16]	*	50 ml probówka z dnem stożkowym bez rantu (30 x 115 mm), Greiner® 50 ml tube, conical bottom, without skirt (30 x 115 mm), Greiner®

14850 Rmax 184 RCF 3804

[4]	15040	100 ml probówka z pokrywką (45,2 x 103,7 mm) 100 ml tube with cap (45,2 x 103,7 mm)
[4]	*	100 ml probówka szklana (44 x 100 mm) 100 ml glass tube (44 x 100 mm)

14853 Rmax 184 RCF 3804

[84]	*	2-1,5 ml probówka (10,8x41,8 mm), Eppendorf®; [15011], 2 ml (10,8x41,8 mm); [15128], 1,5ml (10,8x40,5 mm)
[84]	*	2 ml probówki z filtrem - spin columns (10,8 x 46 mm) 2 ml spin columns (with filter) (10,8 x 46 mm); [15011], 2 ml (10,8x41,8 mm); [15128], 1,5ml

14854 Rmax 184 RCF 3804

[4]	15440	200 ml butelka płaskodenna (56 x 112 mm), Herolab® nr 25 33 73 200 ml bottle, flat bottom (56 x 112 mm), Herolab® no. 25 33 73
-----	-------	---

14861 Rmax 184 RCF 3804

[96]	*	Sarstedt S-Monovette® (8 x 66 mm), (1,1; 1,2; 1,4 ml) Sarstedt S-Monovette® (8 x 66 mm), (1,1; 1,2; 1,4 ml)
------	---	--

14867 Rmax 184 RCF 3804

[36]	*	15 ml probówka z dnem stożkowym z zakrętką (17 x 120 mm), Falcon®; [15050], 15ml (17 x 120 mm) 15 ml tube, conical bottom, with cap (17 x 120 mm), Falcon®; [15050] 15ml Sarstedt®(17 x 120
------	---	--

bez wkładki/without adapter Rmax 184 RCF 3804

[4]	15852	500 ml butelka (84 x 135 mm), Herolab® nr 25 36 11 500 ml bottle (84 x 135 mm), Herolab® no. 25 36 11
-----	-------	--

A. Wyposażenie dodatkowe/Optional accessories
MPW-380/R

		14851+14017 Rmax 184 RCF 3804
[4]	*	250 ml butelka okrągłodenna (62 x 122 mm), Herolab® nr 25 34 43 250 ml round-bottom bottle (62 x 122 mm), Herolab® no. 25 34 43
		14851+14175 Rmax 184 RCF 3804
[4]	15175	250 ml butelka płaskodenna (62 x 122 mm), Herolab® nr 25 34 21 250 ml bottle, flat bottom (62 x 122 mm), Herolab® no. 25 34 21
[4]	15176	250 ml butelka płaskodenna (62 x 122 mm), Herolab® nr 25 34 01 250 ml bottle, flat bottom (62 x 122 mm), Herolab® no. 25 34 01
		14847 Rmax 184 RCF 3804
[48]	15050	15 ml probówka z dnem stożkowym z zakrętką (17 x 120 mm), Sarstedt® 15 ml tube, conical bottom, with cap (17 x 120 mm), Sarstedt®
		14859 Rmax 184 RCF 3804
[12]	*	50 ml probówka szklana (35 x 100 mm) 50 ml glass tube (35 x 100 mm)
		14850+14159 Rmax 184 RCF 3804
[4]	*	50 ml probówka szklana (35 x 100 mm) 50 ml glass tube (35 x 100 mm)
		13865 R max 183 RCF 3783
		14043 Rmax 183 RCF 3783
[28]	*	Greiner Vacuette® (13 x 75 mm), (1-4,5 ml)
[28]	*	5 ml probówka szklana (12 x 75 mm) 5 ml glass tube (12 x 75 mm)
[28]	*	5 ml probówka z korkiem (12 x 85 mm), Sarstedt® 5 ml tube with cap (12 x 85 mm), Sarstedt®
		14071 Rmax 183 RCF 3783
[28]	15055	30 ml probówka z pokrywką (25,4 x 103,2 mm) 30 ml tube with cap (25,4 x 103,2 mm)
[28]	*	28 ml Thermo Nalgene® Oak Ridge (25,4 x 101,8 mm)
[28]	*	30 ml probówka z pokrywką (25,5 x 94 mm), Nalgene® 30 ml tube with cap (25,5 x 94 mm), Nalgene®
[28]	*	30 ml Thermo Nalgene® Oak Ridge (25,5 x 94,3 mm) 30 ml Thermo Nalgene® Oak Ridge (25,5 x 94,3 mm)
[28]	*	25 ml probówka szklana (25 x 100 mm) 25 ml glass tube (25 x 100 mm)
		14073 Rmax 183 RCF 3783
[28]	*	BD Vacutainer® (16 x 100 mm), (2,5-11 ml)
[28]	*	Greiner Vacuette® (16 x 100 mm), (7-9 ml)
[28]	*	Sarstedt S-Monovette® (15 x 92 mm), (7,5; 8,2; 8,5 ml)
[28]	15046	14 ml probówka z pokrywką (16,8 x 113,7 mm), Sarstedt® 14 ml tube with cap (16,8 x 113,7 mm), Sarstedt®
[28]	*	Sarstedt S-Monovette® (16 x 92 mm), (9; 10 ml)
[28]	15118	10 ml probówka szklana (16 x 100 mm) 10 ml glass tube (16 x 100 mm)
[28]	*	15 ml Thermo Nalgene® (16 x 113 mm) 15 ml Thermo Nalgene® (16 x 113 mm)
[28]	*	10 ml probówka z pokrywką (16 x 106 mm) 10 ml tube with cap (16 x 106 mm)
		14089 Rmax 183 RCF 3783
[4]	*	15 ml probówka z dnem stożkowym z zakrętką (17 x 120 mm), Falcon®; [15050], 15ml (17 x 120 mm) 15 ml tube, conical bottom, with cap (17 x 120 mm), Falcon®; [15050] 15ml Sarstedt®(17 x 120 mm)
		bez wkładki/without adapter Rmax 183 RCF 3783
[28]	*	50 ml probówka z dnem stożkowym z zakrętką (30 x 117 mm), Falcon®; [15052] 50ml (30 x 117mm) 50 ml tube, conical bottom, with cap (30 x 117 mm), Falcon®; [15052] 50ml Sarstedt® (30 x 117
[28]	*	50 ml probówka z dnem stożkowym bez rantu (30 x 115 mm), Greiner® 50 ml tube, conical bottom, without skirt (30 x 115 mm), Greiner®
		13866 R max 186 RCF 3845
		14043 Rmax 186 RCF 3845
[24]	*	Greiner Vacuette® (13 x 75 mm), (1-4,5 ml)
[24]	*	5 ml probówka szklana (12 x 75 mm) 5 ml glass tube (12 x 75 mm)
[24]	*	5 ml probówka z korkiem (12 x 85 mm), Sarstedt® 5 ml tube with cap (12 x 85 mm), Sarstedt®
		14071 Rmax 186 RCF 3845
[24]	15055	30 ml probówka z pokrywką (25,4 x 103,2 mm) 30 ml tube with cap (25,4 x 103,2 mm)
[24]	*	28 ml Thermo Nalgene® Oak Ridge (25,4 x 101,8 mm)
[24]	*	30 ml probówka z pokrywką (25,5 x 94 mm), Nalgene® 30 ml tube with cap (25,5 x 94 mm), Nalgene®

* probówka niedostępna w ofercie MPW lub dostępny odpowiednik (np.[15050]), patrz kolumna z prawej
tube is not offered by MPW or equivalent is available (e.g. [15050]), see column on the right

A. Wyposażenie dodatkowe/Optional accessories
MPW-380/R

[24]	*	30 ml Thermo Nalgene® Oak Ridge (25,5 x 94,3 mm) 30 ml Thermo Nalgene® Oak Ridge (25,5 x 94,3 mm)
[24]	*	25 ml probówka szklana (25 x 100 mm) 25 ml glass tube (25 x 100 mm) 14073 Rmax 186 RCF 3845
[24]	15046	14 ml probówka z pokrywką (16,8 x 113,7 mm), Sarstedt® 14 ml tube with cap (16,8 x 113,7 mm), Sarstedt®
[24]	*	BD Vacutainer® (16 x 100 mm), (2,5-11 ml)
[24]	*	Greiner Vacuette® (16 x 100 mm), (7-9 ml)
[24]	*	Sarstedt S-Monovette® (15 x 92 mm), (7,5; 8,2; 8,5 ml)
[24]	*	Sarstedt S-Monovette® (16 x 92 mm), (9; 10 ml)
[24]	15118	10 ml probówka szklana (16 x 100 mm) 10 ml glass tube (16 x 100 mm)
[24]	*	15 ml Thermo Nalgene® (16 x 113 mm) 15 ml Thermo Nalgene® (16 x 113 mm)
[24]	*	10 ml probówka z pokrywką (16 x 106 mm) 10 ml tube with cap (16 x 106 mm) 14089 Rmax 186 RCF 3845
[4]	*	15 ml probówka z dnem stożkowym z zakrętką (17 x 120 mm), Falcon®; [15050], 15ml (17 x 120 mm) 15 ml tube, conical bottom, with cap (17 x 120 mm), Falcon®; [15050] 15ml Sarstedt®(17 x 120 mm) bez wkładki/without adapter Rmax 186 RCF 3845
[24]	*	50 ml probówka z dnem stożkowym z zakrętką (30 x 117 mm), Falcon®; [15052] 50ml (30 x 117mm) 50 ml tube, conical bottom, with cap (30 x 117 mm), Falcon®; [15052] 50ml Sarstedt® (30 x 117
[24]	*	50 ml probówka z dnem stożkowym bez rantu (30 x 115 mm), Greiner® 50 ml tube, conical bottom, without skirt (30 x 115 mm), Greiner® 13833+17834 R max 184 RCF 3804 14845 Rmax 184 RCF 3804
[72]	*	BD Vacutainer® (13 x 75 mm), (1,6-5,3 ml)
[72]	*	BD Vacutainer® (13 x 100 mm), (4-7 ml)
[72]	*	Greiner Vacuette® (13 x 75 mm), (1-4,5 ml)
[72]	*	Greiner Vacuette® (13 x 100 mm), (3,5-6 ml)
[72]	*	Sarstedt S-Monovette® (11 x 66 mm), (1,6; 2; 2,7; 3; 3,1 ml)
[72]	*	Sarstedt S-Monovette® (13 x 65 mm), (2,6; 2,9; 3,4; 3,8 ml)
[72]	*	Sarstedt S-Monovette® (13 x 75 mm), (2,7; 3; 4,3 ml)
[72]	*	Sarstedt S-Monovette® (11 x 92 mm), (4,5; 5 ml)
[72]	*	Sarstedt S-Monovette® (13 x 90 mm), (4,9; 5,6 ml)
[72]	*	5 ml probówka szklana (12 x 75 mm) 5 ml glass tube (12 x 75 mm)
[72]	*	5 ml probówka z korkiem (12 x 85 mm), Sarstedt® 5 ml tube with cap (12 x 85 mm), Sarstedt®
[72]	*	7 ml probówka szklana (12 x 100 mm) 7 ml glass tube (12 x 100 mm)
[72]	*	6 ml probówka z pokrywką (11,5 x 92 mm), Sarstedt® 6 ml tube with cap (11,5 x 92 mm), Sarstedt® 14846 Rmax 184 RCF 3804
[48]	15046	14 ml probówka z pokrywką (16,8 x 113,7 mm), Sarstedt® 14 ml tube with cap (16,8 x 113,7 mm), Sarstedt®
[48]	*	BD Vacutainer® (16 x 100 mm), (2,5-11 ml)
[48]	*	Greiner Vacuette® (16 x 100 mm), (7-9 ml)
[48]	*	Sarstedt S-Monovette® (15 x 92 mm), (7,5; 8,2; 8,5 ml)
[48]	*	10 ml Thermo Nalgene® Oak Ridge (16 x 81,5 mm)
[48]	15118	10 ml probówka szklana (16 x 100 mm) 10 ml glass tube (16 x 100 mm)
[48]	*	10 ml probówka z pokrywką (16 x 106 mm) 10 ml tube with cap (16 x 106 mm) 14848 Rmax 184 RCF 3804
[20]	15055	30 ml probówka z pokrywką (25,4 x 103,2 mm) 30 ml tube with cap (25,4 x 103,2 mm)
[20]	*	28 ml Thermo Nalgene® Oak Ridge (25,4 x 101,8 mm)
[20]	*	30 ml Thermo Nalgene® Oak Ridge (25,5 x 94,3 mm) 30 ml Thermo Nalgene® Oak Ridge (25,5 x 94,3 mm)
[20]	*	25 ml probówka szklana (25 x 100 mm) 25 ml glass tube (25 x 100 mm) 14849 Rmax 184 RCF 3804
[16]	*	50 ml probówka z dnem stożkowym z zakrętką (30 x 117 mm), Falcon®; [15052] 50ml (30 x 117mm) 50 ml tube, conical bottom, with cap (30 x 117 mm), Falcon®; [15052] 50ml Sarstedt® (30 x 117
[16]	*	50 ml probówka z dnem stożkowym bez rantu (30 x 115 mm), Greiner® 50 ml tube, conical bottom, without skirt (30 x 115 mm), Greiner® 14850 Rmax 184 RCF 3804

A. Wyposażenie dodatkowe/Optional accessories				
MPW-380/R				
[4]	15040	100 ml probówka z pokrywką (45,2 x 103,7 mm) 100 ml tube with cap (45,2 x 103,7 mm)		
[4]	*	100 ml probówka szklana (44 x 100 mm) 100 ml glass tube (44 x 100 mm)		
		14853 Rmax 184 RCF 3804		
[84]	*	2-1,5 ml probówka (10,8x41,8 mm), Eppendorf®; [15011], 2 ml (10,8x41,8 mm); [15128], 1,5ml (10,8x40,5 mm)		
[84]	*	2 ml probówki z filtrem - spin columns (10,8 x 46 mm) 2 ml spin columns (with filter) (10,8 x 46 mm); [15011], 2 ml (10,8x41,8 mm); [15128], 1,5ml		
		14854 Rmax 184 RCF 3804		
[4]	15440	200 ml butelka płaskodenna (56 x 112 mm), Herolab® nr 25 33 73 200 ml bottle, flat bottom (56 x 112 mm), Herolab® no. 25 33 73		
		14861 Rmax 184 RCF 3804		
[96]	*	Sarstedt S-Monovette® (8 x 66 mm), (1,1; 1,2; 1,4 ml) Sarstedt S-Monovette® (8 x 66 mm), (1,1; 1,2; 1,4 ml)		
		14867 Rmax 184 RCF 3804		
[36]	*	15 ml probówka z dnem stożkowym z zakrętką (17 x 120 mm), Falcon®; [15050], 15ml (17 x 120 mm) 15 ml tube, conical bottom, with cap (17 x 120 mm), Falcon®; [15050] 15ml Sarstedt®(17 x 120 bez wkładki/without adapter Rmax 184 RCF 3804		
[4]	15852	500 ml butelka (84 x 135 mm), Herolab® nr 25 36 11 500 ml bottle (84 x 135 mm), Herolab® no. 25 36 11		
		14851+14017 Rmax 184 RCF 3804		
[4]	*	250 ml butelka okrągłodenna (62 x 122 mm), Herolab® nr 25 34 43 250 ml round-bottom bottle (62 x 122 mm), Herolab® no. 25 34 43		
		14847 Rmax 184 RCF 3804		
[48]	15050	15 ml probówka z dnem stożkowym z zakrętką (17 x 120 mm), Sarstedt® 15 ml tube, conical bottom, with cap (17 x 120 mm), Sarstedt®		
		14859 Rmax 184 RCF 3804		
[12]	*	50 ml probówka szklana (35 x 100 mm) 50 ml glass tube (35 x 100 mm)		
		14850+14159 Rmax 184 RCF 3804		
[4]	*	50 ml probówka szklana (35 x 100 mm) 50 ml glass tube (35 x 100 mm)		
12901				
		RPM 4100 RCF 3533 Rmax 188 \neq 90		
13975+17975				
		bez wkładki/without adapter		
[4]	*	750ml butelka (100x130mm), Herolab® nr 25 37 35 750 ml bottle (100 x 130 mm), Herolab® no. 25 37 35		
		14902		
[28]	*	50 ml probówka z dnem stożkowym z zakrętką (30 x 117 mm), Falcon®; [15052] 50ml (30 x 117mm) 50 ml tube, conical bottom, with cap (30 x 117 mm), Falcon®; [15052] 50ml Sarstedt® (30 x 117		
[28]	*	50 ml probówka z dnem stożkowym bez rantu (30 x 115 mm), Greiner® 50 ml tube, conical bottom, without skirt (30 x 115 mm), Greiner®		
		14903		
[88]	*	BD Vacutainer® (16 x 100 mm), (2,5-11 ml)		
[88]	*	Greiner Vacuette® (16 x 100 mm), (7-9 ml)		
[88]	*	10 ml Thermo Nalgene® Oak Ridge (16 x 81,5 mm)		
[88]	15118	10 ml probówka szklana (16 x 100 mm) 10 ml glass tube (16 x 100 mm)		
[88]	*	15 ml Thermo Nalgene® (16 x 113 mm) 15 ml Thermo Nalgene® (16 x 113 mm)		
		14904		
[100]	*	BD Vacutainer® (13 x 75 mm), (1,6-5,3 ml)		
[100]	*	BD Vacutainer® (13 x 100 mm), (4-7 ml)		
[100]	*	Greiner Vacuette® (13 x 75 mm), (1-4,5 ml)		
[100]	*	Greiner Vacuette® (13 x 100 mm), (3,5-6 ml)		
[100]	*	Sarstedt S-Monovette® (13 x 65 mm), (2,6; 2,9; 3,4; 3,8 ml)		
[100]	*	Sarstedt S-Monovette® (13 x 75 mm), (2,7; 3; 4,3 ml)		
[100]	*	Sarstedt S-Monovette® (13 x 90 mm), (4,9; 5,6 ml)		
[100]	*	7 ml probówka szklana (12 x 100 mm) 7 ml glass tube (12 x 100 mm)		
[100]	*	5 ml probówka szklana (12 x 75 mm) 5 ml glass tube (12 x 75 mm)		
		14901		
[56]	*	15 ml probówka z dnem stożkowym z zakrętką (17 x 120 mm), Falcon®; [15050], 15ml (17 x 120 mm) 15 ml tube, conical bottom, with cap (17 x 120 mm), Falcon®; [15050] 15ml Sarstedt®(17 x 120		
12926				
		RPM 5700 RCF 5085 Rmax 140 \neq 90		

* probówka niedostępna w ofercie MPW lub dostępny odpowiednik (np.[15050]), patrz kolumna z prawej
tube is not offered by MPW or equivalent is available (e.g. [15050]), see column on the right

A. Wyposażenie dodatkowe/Optional accessories**MPW-380/R**

13927

bez wkładki/without adapter

[4]	*	płytki titracyjna DWP 96/2000 μ l (127,8x85,5x44,1 mm) deepwell plate DWP 96/2000 μ l (127,8 x 85,5 x 44,1 mm)
[10]	*	płytki titracyjna MTP 28,8ml (86x128x15/17,5 mm) microtiter plate MTP 28,8 ml (86 x 128 x 15/17,5 mm)

Suma końcowa

EU DECLARATION OF CONFORMITY

This EU declaration of conformity is issued under the sole responsibility of the manufacturer.

Manufacturer: "MPW MED. INSTRUMENTS" SPÓŁDZIELNIA PRACY
46 Boremlowska Street, 04-347 Warsaw, Poland

The Quality Management System complies with the standards: PN-EN ISO 9001:2015, PN-EN ISO 13485:2016

SRN: PL-MF-000032831

Device name: Laboratory centrifuge MPW-380
(with the accessory indicated in the operating instructions provided with the centrifuge)

BASIC UDI-DI: 590538636-IVD-CEN-011-62

Catalogue numbers: 10380/2-56 10380/1-56 10380/1-56/100
10380/1-56/110 10380/1-56/127

The aforementioned device is in conformity with the following EU regulations and directives:

2017/746 (IVDR) REGULATION (EU) 2017/746 OF THE EUROPEAN PARLIAMENT AND OF THE COUNCIL of 5 April 2017 on in vitro diagnostic medical devices and repealing Directive 98/79/EC and Commission Decision 2010/227/EU, including the changes published prior to the date of this declaration.

2011/65/EU (RoHS 2) DIRECTIVE 2011/65/EU OF THE EUROPEAN PARLIAMENT AND OF THE COUNCIL of 8 June 2011 on the restriction of the use of certain hazardous substances in electrical and electronic equipment, including the changes published prior to the date of this declaration.

Intended purpose: The device is intended for the separation of the mixtures of the liquid substances derived from the human body, including blood, urine, and other body fluids, and for the preparation of the samples intended for further in vitro diagnostics procedures.

Risk class: Class A
(in accordance with the rule 5 of Annex VIII of Regulation (EU) 2017/746).

The conformity assessment of the device and accessory has been carried out in accordance with Article 48(10) of Regulation (EU) 2017/746.

Wojciech Anisiewicz
Vice-President of the Management Board

Łukasz Szański
President of the Management Board

EU DECLARATION OF CONFORMITY

This EU declaration of conformity is issued under the sole responsibility of the manufacturer.

Manufacturer: "MPW MED. INSTRUMENTS" SPÓŁDZIELNIA PRACY
46 Boremlowska Street, 04-347 Warsaw, Poland

The Quality Management System complies with the standards: PN-EN ISO 9001:2015, PN-EN ISO 13485:2016

SRN: PL-MF-000032831

Device name: Refrigerated laboratory centrifuge MPW-380R
(with the accessory indicated in the operating instructions provided with the centrifuge)

BASIC UDI-DI: 590538636-IVD-CEN-012-65

Catalogue numbers: 10380R/2-56 10380R/1-6 10380R/1-6/100
10380R/1-6/110 10380R/1-6/127

The aforementioned device is in conformity with the following EU regulations and directives:

2017/746 (IVDR) REGULATION (EU) 2017/746 OF THE EUROPEAN PARLIAMENT AND OF THE COUNCIL of 5 April 2017 on in vitro diagnostic medical devices and repealing Directive 98/79/EC and Commission Decision 2010/227/EU, including the changes published prior to the date of this declaration.

2011/65/EU (RoHS 2) DIRECTIVE 2011/65/EU OF THE EUROPEAN PARLIAMENT AND OF THE COUNCIL of 8 June 2011 on the restriction of the use of certain hazardous substances in electrical and electronic equipment, including the changes published prior to the date of this declaration.

Intended purpose: The device is intended for the separation of the mixtures of the liquid substances derived from the human body, including blood, urine, and other body fluids, and for the preparation of the samples intended for further in vitro diagnostics procedures.

Risk class: Class A
(in accordance with the rule 5 of Annex VIII of Regulation (EU) 2017/746).

The conformity assessment of the device and accessory has been carried out in accordance with Article 48(10) of Regulation (EU) 2017/746.

Wojciech Anisiewicz
Vice-President of the Management Board

Łukasz Satański
President of the Management Board

DECLARATION OF DECONTAMINATION

(repair)

In order to protect our employees please fill out the declaration of decontamination completely before sending centrifuge to the manufacturer (repair).

If it is impossible to completely and effectively decontaminate the device, it should be treated in accordance with the regulations for medical waste.

1. Device:

– type:

– serial No.:

2. Description of decontamination

(see user manual)

.....

.....

.....

.....

3. Decontamination carried out by:

name:

4. Date and signature:

.....

DECLARATION OF DECONTAMINATION

(return)

In order to protect our employees please fill out the declaration of decontamination completely before sending centrifuge to the manufacturer (return).

If it is impossible to completely and effectively decontaminate the device, it should be treated in accordance with the regulations for medical waste.

1. Device:

– type:
– serial No.:

2. Description of decontamination

(see user manual)

.....
.....
.....
.....

3. Decontamination carried out by:

name:

4. Date and signature:

.....

NOMOGRAM

Centrifuging radius [cm]

R.C.F. (x "g")
multiple of
gravitational
acceleration

[r.p.m.]

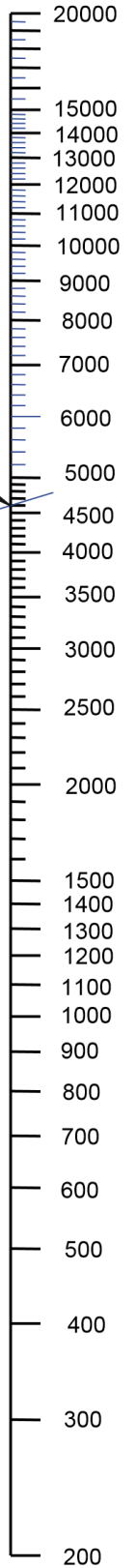
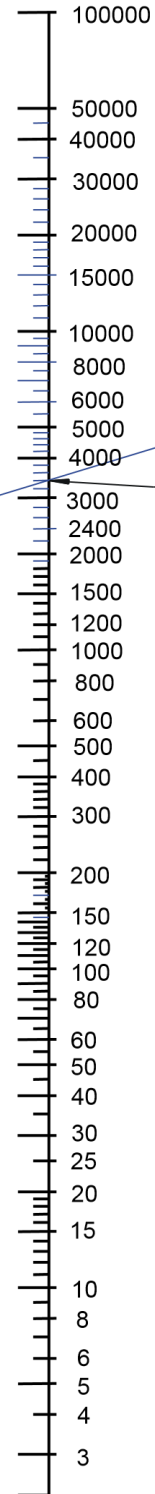
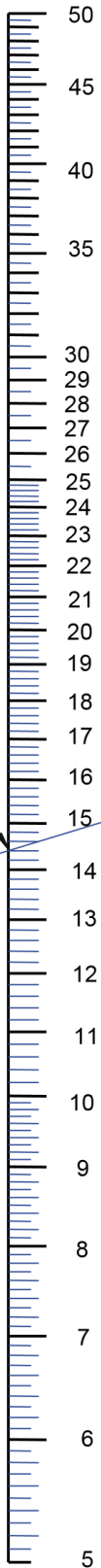

Formula used for calculation of this nomogram :

$$R.C.F. = 11,18 * r * (n/1000)^2$$

where :

- R.C.F. - multiple of gravitational acceleration
- r - centrifuging radius (cm)
- n - rotational speed (r.p.m.)
- g - gravitational acceleration

Example of making use
of the nomogram:

A=14,4 cm
B=4600 r.p.m.
C=3400 x g

$$n = 1000 * \sqrt{\frac{RCF}{(11,18 * r)}}$$

$$r = \frac{RCF}{\left[11,18 * \left(\frac{n}{1000} \right)^2 \right]}$$

A

B

C