

# USER MANUAL



Laboratory centrifuge **MPW-380**

Refrigerated laboratory centrifuge **MPW-380R**

**Read before use!**

Serial number of the centrifuge: .....

For centrifuges with serial no (SN): MPW-380: from 10380032322  
MPW-380R: from 10380R032122



This manual was prepared with special care. MPW MED. INSTRUMENTS may change the manual at any time and without notice because of improvements, typographical errors, or improvements to facilities  
All rights reserved. No part of this User Manual may be modified, distributed, published, or reproduced without the prior permission of MPW MED. INSTRUMENTS.

You can find the current version of the user manual on our website under:









**www.mpw.pl** **DOWNLOAD** section (one should choose demanded language version of website).

# Content

<b>1. Symbols used in the manual and on the device</b> .....	<b>5</b>
<b>2. Application</b> .....	<b>5</b>
<b>3. Technical specification</b> .....	<b>6</b>
3.1 Environmental conditions .....	6
<b>4. Installation</b> .....	<b>7</b>
4.1 Content of the package .....	7
4.2 Location .....	7
4.3 Current protection .....	8
<b>5. Safety notes</b> .....	<b>8</b>
5.1 General remarks .....	8
5.2 Filling the rotor .....	8
5.2.1 <i>Angular rotors</i> .....	8
5.2.2 <i>Horizontal rotors</i> .....	8
5.2.3 <i>Filling tubes</i> .....	9
5.3 Safety hints .....	10
5.4 Operating conditions .....	10
5.5 Equipment life .....	11
5.6 Work safety .....	11
5.7 Unbalance .....	12
5.8 Emergency stop .....	12
5.9 Residual risk .....	12
<b>6. Operating</b> .....	<b>13</b>
6.1 Centrifuge overview .....	13
6.2 Centrifuge description .....	13
6.3 Construction .....	13
6.4 Name plate .....	14
6.5 Rotor and accessories installation .....	14
6.6 Control device .....	15
6.7 Setting parameters .....	15
6.8 Safety features .....	15
6.9 Increase in temperature (MPW-380 only) .....	15
<b>7. Centrifuging</b> .....	<b>15</b>
7.1 Control panel .....	16
7.2 Display .....	16
7.3 Setting up RPM, RCF, time, temperature .....	18
7.4 Users programs .....	19
7.5 Creator of acceleration and deceleration curves .....	21
7.5.1 <i>Acceleration characteristic, Creation of episode 1</i> .....	22
7.5.2 <i>Adding and editing sections - acceleration</i> .....	22
7.5.3 <i>Acceleration graph</i> .....	23
7.5.4 <i>Deceleration characteristic – creating section 1</i> .....	23
7.5.5 <i>Adding and editing sections - deceleration</i> .....	24
7.5.6 <i>Deceleration graph</i> .....	24
7.5.7 <i>Deleting sections</i> .....	25
7.6 Programs with user characteristics .....	25
7.7 Rotor choosing .....	25
7.8 SHORT mode .....	25
7.9 Finishing the centrifuging .....	26
7.10 Temporarily disabled functions .....	26
<b>8. Temperature control</b> .....	<b>26</b>
8.1 Initial cooling during centrifuging –FAST COOL .....	27
8.2 Initial cooling or heating without centrifuging – THERMAL CHAMBER .....	27

8.3	Cooling or heating in “START DELAY – OF TEMPERATURE” mode .....	28
8.4	Cooling or heating in „SHORT” mode .....	28
8.5	Cooling and heating notes .....	28
<b>9.</b>	<b>Parameters of centrifugation .....</b>	<b>28</b>
9.1	Acceleration/deceleration – changing characteristics .....	29
9.2	Radius .....	29
9.3	Sample density .....	29
9.4	Temperature offset .....	30
9.5	Thermal chamber .....	30
9.6	Automatic lid opening .....	31
9.7	Start delay - of time .....	31
9.8	Start delay – of temperature .....	32
9.9	Printing report (USB) .....	32
<b>10.</b>	<b>Menu .....</b>	<b>36</b>
10.1	Screen saver .....	36
10.2	Visual alarm .....	36
10.3	Types of main screen .....	37
10.3.1	Switching the normal display to simplified display .....	37
10.3.2	Switching the simplified screen to normal display .....	37
10.4	Rotating runtime .....	38
10.5	Buzzer .....	38
10.6	Date/time .....	38
10.7	Language .....	38
10.8	Other .....	39
10.9	Password .....	40
10.10	Last 10 cycles .....	41
10.11	Work time .....	41
10.12	Rotor runtime .....	41
10.13	Contact us .....	42
10.14	Diagnostics .....	42
10.15	Factory settings .....	42
<b>11.</b>	<b>Maintenance .....</b>	<b>43</b>
11.1	Cleaning of the centrifuge .....	43
11.2	Maintenance of centrifuge elements .....	43
11.3	Sterilization .....	44
11.3.1	Autoclaving .....	45
11.4	Chemical resistance .....	45
<b>12.</b>	<b>Troubleshooting .....</b>	<b>46</b>
12.1	Messages .....	47
12.2	Emergency cover release .....	48
<b>13.</b>	<b>Guarantee .....</b>	<b>48</b>
<b>14.</b>	<b>Transport and storage .....</b>	<b>49</b>
<b>15.</b>	<b>Disposal .....</b>	<b>49</b>
<b>16.</b>	<b>Manufacturer’s info .....</b>	<b>50</b>
<b>Distributor’s info .....</b>		<b>50</b>
<b>17.</b>	<b>ANNEXES .....</b>	<b>50</b>
A.	Additional accessories	
B.	Declaration of conformity (CE, ROHS 2)	
C.	Declaration of decontamination (repair / return)	
D.	Nomogram RPM / RCF	

## 1. Symbols used in the manual and on the device

Symbol	Explanation
	<b>WARNING!</b> Warning of potential injury or health risk
	<b>DANGER!</b> Risk of electric shock with potential for severe injury or death as a consequence
	<b>DANGER!</b> Biohazard with potential for risk to health or death as a consequence
	<b>DANGER!</b> Risk of explosion with potential for severe injury or death as a consequence
	Symbol identifying a medical device for in vitro diagnostic use
	CE mark
	Symbol informing about the method of disposal
	Please read the instruction manual before you start working with the device
	Manufacturer's data

## 2. Application

The MPW-380/R centrifuges are tabletop laboratory centrifuge for in vitro diagnostic (IVD). Devices are used for separation samples taken from people's, animal's, and plant's components of different densities, under the influence of the centrifugal force, to provide information about their biological state (MPW-380 – ventilated, MPW-380R – with cooling)

Its construction ensures easy operation, safe work, and wide range of applications at laboratories engaged in routine medical analyses, biochemical research works etc.

In the centrifuge, it is prohibited to centrifuge caustic, inflammable, and explosive preparations.

### 3. Technical specification

manufacturer	"MPW MED. INSTRUMENTS" SPÓŁDZIELNIA PRACY, Boremlowska 46 Street, 04-347 Warsaw									
type	<b>MPW - 380</b>					<b>MPW - 380R</b>				
mains voltage (L1+N+PE)	230V	100V	110V	120V	127V	230V	100V	110V	120V	127V
	±10%					±5%				
mains frequency,	50/60Hz		50Hz/60Hz			50Hz	60Hz	60Hz		
power consumption (max.)	800W					1300W				
current protection [A]	10A		12A			18A		20A		
cooling medium	-					R452A (CFC/HCFC free)				
	<b>MPW - 380</b>					<b>MPW - 380R</b>				
capacity (max.)	3000 ml									
speed – RPM	90 ÷ 18000 RPM (step 1 RPM)									
force – RCF	31876 x g (step 1 x g)									
kinetic energy (max.)	19559 Nm									
running time	00:00:01 ÷ 99:59:59 – [hours, min., sec] (step 1s)									
time counting	since start button is pressed / since preselected speed is reached									
short-time operation mode – SHORT	yes									
continuous operation mode – HOLD	yes									
menu languages	POLISH, ENGLISH, GERMAN, SPANISH, ITALIAN, PORTUGUESE, RUSSIAN, SWEDISH, FRENCH, CZECH									
user programs	100									
adjustable temperature	-					-20 ÷ 40°C* (step 1°C)				
cooling / heating	no / no					yes / no				
guaranteed temperature with max. rotor speed	-					≤4°C				
cooling	no					yes				
cooling without centrifuging	no					yes				
acceleration (ACEL)	10 linear curves									
deceleration (DECEL)	10 linear curves									
programmable non-linear curves:										
acceleration						10				
deceleration						10				
USB communication	yes									
Electromagnetic compatibility	according to EN 61326-2-6:2006									
degree of protection	IP21					IP21				
height (H)	455 mm					455 mm				
width (W)	515 mm					715 mm				
depth (D)	650 mm					650 mm				
height with open cover (H <sub>oc</sub> )	960 mm					960 mm				
noise level	<67 dB									
weight 230V	approx. 76 kg					approx. 114 kg				
weight 120V	approx. 81,5 kg					approx. 120 kg				

\*time and possibility of obtaining a set temperature is dependent on multiple factors , including rotor type, established RPM, ambient temperature; accuracy: - ±1°C appropriate for place of temperature sensor

#### 3.1 Environmental conditions

- The device may only be used indoors.
- The permissible ambient temperature is 2°C to 40°C.
- Maximum allowed relative humidity 80% at temperature up to 31°C decreasing linearly to 50% relative humidity at 40°C.
- The mains voltage fluctuations must not exceed ± 10% of the nominal voltage.
- Maximum altitude 2,000 m above sea level.
- Overvoltage category II.
- Pollution degree 2.



## 4. Installation

Open the package. Remove the box containing the accessories. Take out centrifuge from the container. Keep the box and packing materials in case of service shipping.

### 4.1 Content of the package

name	pcs.	cat no.
centrifuge MPW-380/R	1	10380/2-56 10380/1-56 10380R/2-56 10380R/1-6 (type and supply version dependent)
complete clamp	1	17798
spanner for the rotor/ emergency opening of the cover	1	17799
power cord 230V / 120V	1	17009/17010
Vaseline 20ml	1	17201
USB A-A cable	1	16655
user manual	1	See page 1

### 4.2 Location

	<ul style="list-style-type: none"> <li>▪ Ensure safe location.</li> <li>▪ The centrifuge shall not be located near source of heat and shall not be subjected to direct sunlight.</li> <li>▪ Centrifuge should be flat-levelled. Effect of levelling shall be ensured by stable and flat-levelled tabletop for the centrifuge.</li> <li>▪ Centrifuge should be set horizontally on a rigid base.</li> <li>▪ It is necessary to ensure a ventilation zone of the minimum 30cm round the centrifuge from every direction. Do not veil ventilation holes !</li> <li>▪ Table for centrifuge should possess safety zone of the minimum 30cm round the centrifuge from every direction (safety needs in case of malfunction according to EN 61010-020).</li> <li>▪ Table for centrifuge should be free of containments before locating of centrifuge.</li> <li>▪ Passed parameters of the centrifuge are referring to the above-named temperatures (see <b>Technical specification</b>).</li> <li>▪ At the change of the place from cold to warm one, condensation of water will occur inside the centrifuge. It is important then that sufficient time be provided for drying the centrifuge prior to starting the centrifuge again (min. 4 hours).</li> <li>▪ Do not position the centrifuge so that it is difficult to operate the power switch.</li> <li>▪ Supply voltage given on the name plate has to be consistent with local supply voltage. MPW MED INSTRUMENTS laboratory centrifuges are 1st safety class devices, and they are provided with the three-core cable with the plug resistant to dynamic loadings.</li> <li>▪ Mains sockets have to be provided with the safety pin (protective earth (PE)).</li> <li>▪ It is recommended to install emergency cut-out that shall be located far from the centrifuge, near the exit or beyond the room.</li> </ul>
	<p><b>Before switching on, check whether the centrifuge is connected to power supply correctly. It is obligatory to use only power cord recommended by manufacturer.</b></p>

### 4.3 Current protection



The centrifuge is equipped with thermal current protection. Fuse is situated in the power switch (without an additional fuse).

## 5. Safety notes

### 5.1 General remarks



- The laboratory centrifuge may be operated only by qualified laboratory personnel after getting acquainted with the user's manual.
- **The operating instructions are part of the product.**
- **The instruction manual should always be kept near the centrifuge.**
- The centrifuge cannot be operated inconsistently with its purpose.
- **If the centrifuge is used in a manner inconsistent with the manufacturer's guidelines, the safety of the device operation may be impaired.**

### 5.2 Filling the rotor

#### 5.2.1 Angular rotors



- **Check that the rotor is properly seated and bolted to the motor axis.**
- Do not exceed the maximum rotor load (information is provided on the rotors).
- In order to ensure symmetrical loading, fill opposite openings of the rotor with inserts and test tubes of the same type and weight.

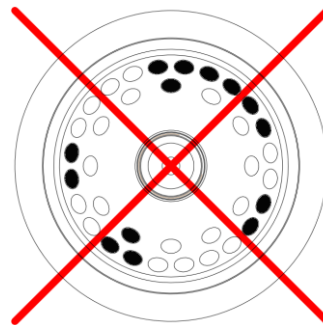

#### 5.2.2 Horizontal rotors

- **Check that the rotor is properly seated and bolted to the motor axis.**
- **Do not exceed the maximum rotor load.**
- To ensure symmetrical and even rotor load, fill opposite slots with containers / hangers of the same type and weight.
- **Horizontal rotors must be filled with a complete set of containers / hangers.**
- Place test tubes symmetrically facing each other.
- Before starting centrifugation, check that all containers / hangers are properly hung and can swing freely.

Place empty test tubes in containers. Manually tilt the containers to the horizontal position, check that there are no collisions between the test tubes, containers / hangers and the rotor.



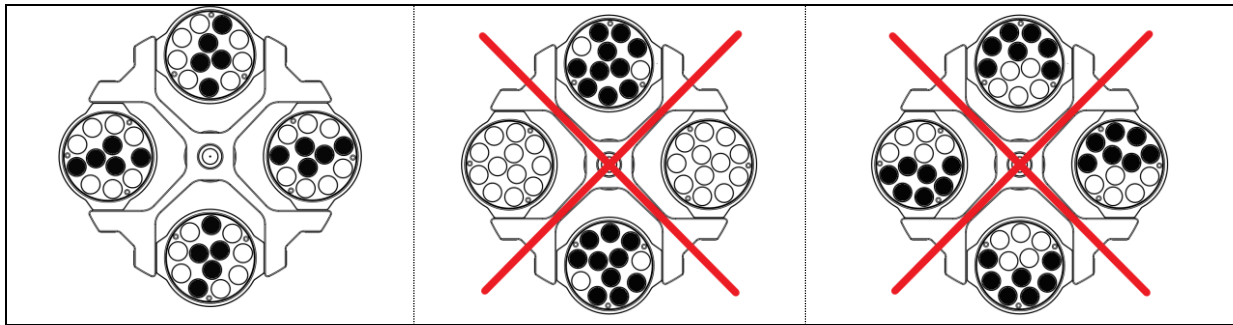

### 5.2.3 Filling tubes

- **Tubes may only be filled outside the centrifuge.**
- Tubes may only be filled with the maximum amount of substance specified by the manufacturer.
- The test tubes must be filled in such a way that the centrifuged substance does not run out of the vessel during centrifugation.

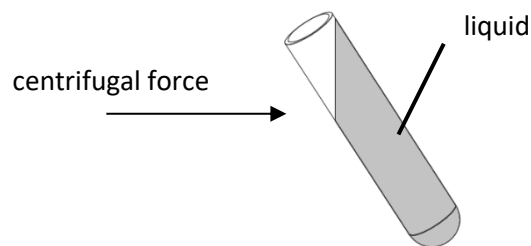

- In case the tube manufacturer has not specified a maximum level, fill the tubes according to the formula:



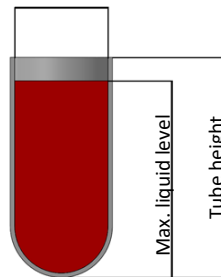

$$\text{Max liquid level} < \text{Tube height} - \frac{\text{Internal tube diameter}}{2}$$

Internal tube diameter







- For centrifugation in the centrifuge, only containers included in the list of equipment and centrifuge tubes, the diameter, length and strength of which are appropriate, should be used. The use of test tubes from other manufacturers should be agreed with MPW MED. INSTRUMENTS or its authorized representatives.
- Pay attention to the quality and appropriate thickness of the walls of glass test tubes. **Glass tubes should be centrifuge tubes.**
- To prevent the centrifuge from being unbalanced, it is recommended to weigh the filled test tubes before inserting them into the rotor. When centrifuging in horizontal rotors, it is recommended to weigh the filled containers / hangers. This will allow to minimize the differences in mass between them, which will positively affect the suspension of the engine and the reduction of noise level during the operation of the centrifuge.

### 5.3 Safety hints

	<p><b>ROTORS MAINTENANCE</b></p> <ul style="list-style-type: none"> <li>▪ Lubricate the swing-out rotor journal pins.</li> <li>▪ Use only accessories in good condition.</li> <li>▪ Protect equipment against corrosion using accurate preventive maintenance.</li> </ul>
	<p><b>HS ACCESSORIES MAINTENANCE</b></p> <ul style="list-style-type: none"> <li>▪ Make sure that rubber O-rings are lightly coated with silicone grease. Use high vacuum grease, e.g., type „C“ by LUBRINA.</li> </ul>
	<p><b>HAZARDOUS MATERIALS</b></p> <ul style="list-style-type: none"> <li>▪ Use infectious materials only in closed containers / rotors with a safety certificate.</li> <li>▪ It is not allowed to centrifuge toxic or infectious materials with damaged hermetic seal of the rotor or test-tube. Proper disinfection procedures should always be carried out, if hazardous substances have contaminated the centrifuge or its accessories.</li> </ul>
	<p><b>EXPLOSIVE, FLAMMABLE MATERIALS</b></p> <ul style="list-style-type: none"> <li>▪ It is not allowed to centrifuge explosive and inflammable materials.</li> <li>▪ Do not centrifuge substances that could react as a result of the application of high energy during centrifugation.</li> <li>▪ The centrifuge cannot work in an environment threatening with explosion.</li> <li>▪ It is not allowed to centrifuge materials that may generate inflammable or explosive mixtures when exposed to air</li> </ul>

### 5.4 Operating conditions

	<p><b>START-UP</b></p> <p>Prior to switching the centrifuge on, one shall carefully read all sections of this user manual in order to ensure smooth operation and avoid damages of this device or its accessories.</p> <ul style="list-style-type: none"> <li>▪ In order to protect the centrifuge against unbalance, fill in the test tubes up to the same weight.</li> </ul>
	<p><b>TRANSPORTATION</b></p> <ul style="list-style-type: none"> <li>▪ Centrifuge must not be transported with the rotor mounted on the shaft.</li> </ul>
	<p><b>GENERAL HINTS</b></p> <ul style="list-style-type: none"> <li>▪ One must use original rotors, tubes and spare parts only.</li> <li>▪ In case of faulty operation of the centrifuge one shall ask for assistance of service of MPW MED. INSTRUMENTS company or its authorized representatives.</li> <li>▪ It is not allowed to switch the centrifuge on if it is not installed properly or rotor is not fitted correctly.</li> </ul>
	<p><b>CENTRIFUGES SUBSTANCES</b></p> <ul style="list-style-type: none"> <li>▪ It is not allowed to exceed load limit set by the manufacturer. Rotors are intended for fluids of average homogeneous density equal to <b>1,2 g/cm<sup>3</sup></b> or smaller when centrifugation is carried out at maximum speed. When fluids of higher density shall be used, then it is necessary to change density of centrifuges sample in <b>PARAM/DENSITY</b> field.</li> <li>▪ Observe the limitation on the permissible mass specified on the rotor/ bucket (e.g., MAX 15g). If the designation is given on the rotor, it refers to the mass of the</li> </ul>

sample. If the designation is given on the bucket, it refers to the mass of the entire load, i.e., **adapter+ tube + sample**.

**Examples:**

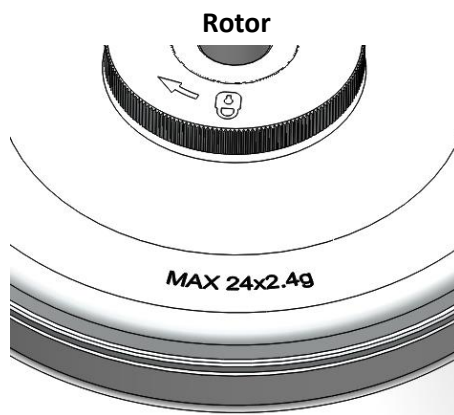

**2,4g** – maximal mass of tube content



**290g** – maximal mass of elements inside bucket

### 5.5 Equipment life

- Each spin cycle during which the rotor has accelerated and decelerated is considered a duty cycle, regardless of the speed and its duration.
- Do not use the equipment after the allowable number of cycles or when the maximum service life has passed, whichever comes first.

### 5.6 Work safety



The centrifuge should be inspected by an authorized service at least once a year (after the warranty period). The reason for more frequent inspection may be, for example, a corrosive environment. Tests should end with issuing a validation protocol, which specifies checking the technical condition of a laboratory centrifuge. It is recommended that you create a document that records all repairs and inspections. Both these documents should be kept in the place where the centrifuge is used.

#### INSPECTION PROCEDURES CARRIED OUT BY THE OPERATOR

Operator has to pay special attention to the fact that the centrifuge parts of key importance due to safety reasons are not damaged. This remark is specifically important as for:

- Centrifuge accessories and especially structural changes, corrosion, preliminary cracks, abrasion of metal parts.
- Screw connections.
- Inspection of seals of the buckets if such are used. Special attention must be paid to all of the rubber (seals) parts. In the case of damage or visible structural changes defective parts must be replaced for new immediately.
- Control of execution of the guarantee yearly technical inspection of the centrifuge (after lapse of guarantee).
- Only the manufacturer-specified buckets, included in the equipment list, as well as centrifuge tubes, which diameter, length and durability are suitable, should be used for spinning in this centrifuge. The use of equipment made by other manufacturers should be consulted with the manufacturer of the centrifuge.
- It is not allowed to lift or shift the centrifuge during operation, and rest on it.
- It is not allowed to stay in the safety zone within 30 cm distance around the centrifuge neither leave within this zone some things, e.g., glass vessels.
- It is not allowed to put any objects on the centrifuge.



	<p><b>COVER OPENING</b></p> <ul style="list-style-type: none"> <li>▪ It is not allowed to open the cover manually in emergency procedure when rotor is still turning.</li> </ul>
	<p><b>ROTORS</b></p> <ul style="list-style-type: none"> <li>▪ It is not allowed to use the rotors, buckets and round carriers with signs of corrosion or other mechanical damage.</li> <li>▪ It is not allowed to centrifuge substances of high corrosive aggressiveness, which may damage the materials and reduce the mechanical properties of rotors, buckets and round carriers.</li> <li>▪ It is not allowed to centrifuge rotors with removed or loose covers.</li> </ul>

### 5.7 Unbalance

The centrifuge is provided with the rotor unbalance sensor and when it will be activated, centrifugation process will be stopped through fast braking and at the same time an error message will be displayed. Erasing the error message is possible by pressing any key (**BACK, STOP, COVER, SET** and **▲ ▼ ◀▶**) after stopping the rotor.

One must check if rotor was correctly loaded, close the cover and once more start the program. In order to protect the rotor against improper work, it has to be provided with identically filled buckets, carriers, test-tubes etc. for getting the best balance possible (see section “**Błąd! Nie można odnaleźć źródła odwołania.**”).

Then close the cover and restart the program.

	<p>Unbalance causes noise and vibrations during operation, and adversely affects power transmission system (motor, shock absorbers). The better balance, the smoother will be the centrifuge operation and therefore longer life of usage of the driveline. Moreover, the ideal separation level is then obtained, as already separated constituents would not be moved up by vibration.</p>
---	--

### 5.8 Emergency stop

In any moment of centrifuging, it is possible interrupt the process and fast stop the rotor. Single time pressing of the **STOP** key will make centrifuging stop with acceleration characteristics set in the program (after pressing the **SET** or **STOP** key, the device returns to the main screen). Pressing and holding it up to 1s will make the centrifuging stop with the strictest characteristic.

### 5.9 Residual risk

The centrifuge is built according to the state-of-the-art and the recognized safety regulations. Nevertheless, still remain some level of residual risk due to improper operation and malfunctions. It is possible to decrease residual risk by strictly applying user manual conditions and correcting malfunction which could threaten safety, immediately.

## 6. Operating

### 6.1 Centrifuge overview

New generation of MPW MED. INSTRUMENTS laboratory centrifuges is provided with state-of-the-art microprocessor control systems, very durable and quiet asynchronous brushless motors, and accessories consistent with requirements of the present-day user.

### 6.2 Centrifuge description

Fig.1. General view

1. Power switch
2. USB
3. Control panel
4. Cover
5. Inspection glass
6. Point of emergency lid opening

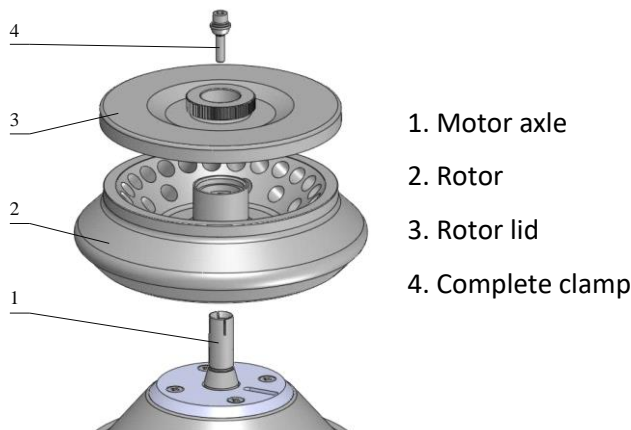
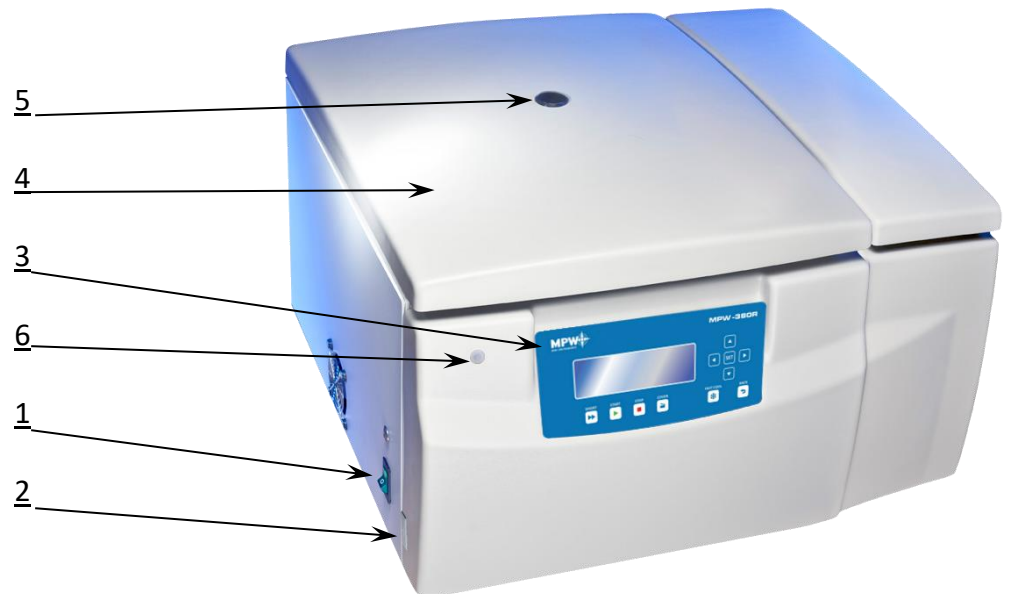

Fig.2. Assembly of angle rotor

Fig.3. Main socket – back of the centrifuge

### 6.3 Construction

The centrifuge has rigid self-supporting structure. Housing was made of sheet aluminum, back made of steel sheet. Front and cover were made of ABS type plastic. Cover is fixed on steel axles of hinges and from the front it is locked with two electromagnetic locks blocking possibility of opening during centrifugation. Rotation chamber casing was made of thick steel sheet. The rotation chamber is made of stainless-steel sheet.

## 6.4 Name plate

The data concerning the device should be read from the rating plate located on the rear wall of the centrifuge (the picture below is an example).

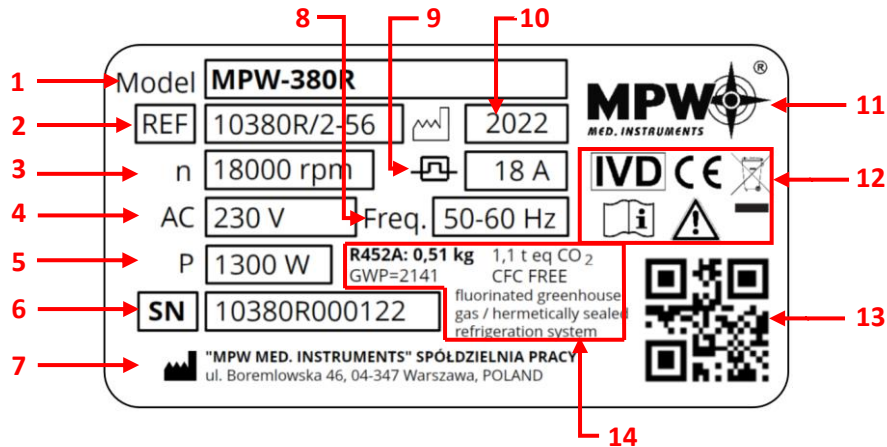

- |                              |  |
|------------------------------|--|
| 1 Centrifuge model           | 9 Current protection   |
| 2 Catalog number             | 10 Year of production  |
| 3 Maximum speed              | 11 Manufacturer's logo   |
| 4 Rated voltage              | 12 Approval marks and symbols (explained in chapter 1)               |
| 5 Maximum rated power        | 13 QR code for serial number   |
| 6 Serial number              | 14 Information about the refrigerant (refrigerated centrifuges only) |
| 7 Manufacturer's information |  |
| 8 Rated frequency            |  |

## 6.5 Rotor and accessories installation

- 

  - Connect the centrifuge to the power source (mains socket at the back of the centrifuge).
  - Turn on the centrifuge (switch on the side of the centrifuge).
  - Open the cover of the centrifuge by pressing the COVER key. Before installing the rotor, check that the centrifugation chamber is free from contamination, e.g., dust, glass splinters, liquid residues that must be removed.
  - Put the rotor on the motor axis by sliding it onto the cone as far as it will go (keeping the coaxially between the rotor and the motor axis).
  - Screw the clamp into the motor shaft (clockwise), then tighten it firmly with the rotor wrench.
  - Swinging rotors must be equipped with buckets in all seats.
  - Container suspension pins should be regularly lubricated with technical petroleum jelly.
  - In the case of rotors with a cover, they must not be used without the cover. Rotor caps must be screwed securely onto the rotor. The rotor and cover are marked with the same catalog number (REF) to eliminate the risk of incorrect selection when the user has several types of rotors. Rotor covers ensure lower rotor resistance, correct tube seating and airtight sealing.
  - Only containers suitable for the selected type of rotor should be used.
  - In order to increase the durability of the rotor and seals, it is recommended to lubricate the rotor pins used to suspend the containers, the undercuts for the pins in the containers, gaskets and threaded places with technical petroleum jelly.

	<ul style="list-style-type: none"> <li>▪ In order to replace the rotor, remove the tubes and containers, loosen the rotor clamp with the provided wrench, counterclockwise, and then use both hands to grasp the rotor on opposite sides and remove it from the motor axis by pulling it upwards.</li> </ul>
--	--

	<p><b>It is recommended to equalize vessels loads as much as possible in order to ensure minimal vibrations during operation.</b></p>
---	---

## 6.6 Control device

The microprocessor control unit of the centrifuge ensures broad possibilities of providing, realization and reading of work parameters.

## 6.7 Setting parameters

Data setting and read-out system forms hermetically closed keyboard with distinctly accessible operation points. Easily readable displays signalling individual performed operations facilitate operator's programming and recording of parameters and condition of the centrifuge. The centrifuge is provided with the USB interface that enables connection of the centrifuge to external PC unit with the printer and recording the centrifugation parameters.

## 6.8 Safety features

### Cover lock

The centrifuge can be started only with properly closed cover. While the cover can be opened only after stopping the rotor. In case of emergency opening of the cover during operation, the centrifuge drive will be immediately switched-off and the rotor will brake till complete stopping.



### Unbalance detecting

When loads of opposite buckets or carriers in rotors are unbalanced, the drive will be switched-off during acceleration or operation of the centrifuge – and the error message will be displayed.

### Rotor verification and checking compatibility with loaded program

Directly after starting centrifuging, a unit verifies the type of the rotor applied and in the case of its incompatibility with the type indicated in the application or absence of the rotor, the spinning process shall be stopped with simultaneous displaying the error message. The conformity of the type of the rotor is signalled with a single audible signal. In case autoidentification (see 9.8 Other) option is checked, proper rotor will be automatically chosen, without user engagement.

### Rest state inspection

Opening the centrifuge lid with the **COVER** key is possible only when the rotor is at rest. Check that the symbol  described in the **Display** chapter is visible on the screen. Use the sight glass on the cover to make sure the impeller is not turning. When the rotor brakes, the symbol  described in the **Display** section is visible. Emergency opening of the cover during rotor spinning is not allowed.

### Checking of excessive temperature

If temperature in rotation chamber exceeds 50°C (MPW-380R) caused by, for example, malfunction of cooling system, drive will be switched off and error message will be displayed. The reboot is only possible after chilling device.

## 6.9 Increase in temperature (MPW-380 only)

In uncooled centrifuges, the temperature in the rotor chamber, rotor and sample can increase to above 40°C, based on the run time, g-force (rcf)/speed and ambient temperature.

# 7. Centrifuging

Power switching ON/OFF is carried out with master switch situated on the left side wall of the centrifuge. All settings on the centrifuge are done by means of the control panel.

## 7.1 Control panel

The control panel placed on the front casing serves the purpose of controlling centrifuge operation.

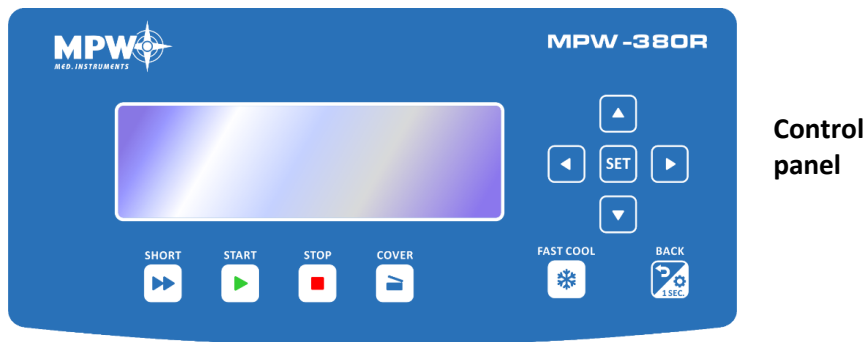

	SHORT <sup>1</sup>	short-time centrifuging
	START	start centrifugation run
	STOP <sup>2</sup>	end centrifugation run
	COVER	cover opening
	FAST COOL	start fast cooling mode (MPW-380R only)
	BACK/ OPTIONS	exit the current menu / enter to submenu of options (keep held down within 1 s.)
	UP	navigation in menu / increasing values
	DOWN	navigation in menu / decreasing values
	LEFT	navigation in menu
	RIGHT	navigation in menu
<b>SET</b>	SET	changing parameters / confirming changes

<sup>1</sup> the centrifuge is working as long as the key is pressed

<sup>2</sup> first-time pressing press – will make stopping centrifuging with acceleration characteristics set in the current program, second-time pressing – will make the centrifuging as fast as possible (quickest characteristic). During setting of the parameters, it serves for exiting zones on the primary screen without introducing changes.

## 7.2 Display

The display is located in the centre of the control panel. The main screen variants are presented below. In the user manual exemplary screens from MPW-380R are shown. For MPW-380 (without refrigeration) temperature is not shown. Blinking of field on display mean it is ready to set. Blinking of field is visualised as highlighted in the user manual.

	<p>After switching on centrifuge, welcome screen appears. After disappearing the welcome screen, it is possible to setting up parameters.</p>
	<p><b>Simplified</b> display mode is set as default, there is possible to switch to <b>normal</b> (see chapter <b>Błąd! Nie można odnaleźć źródła odwołania.</b>).</p>



SPEED 2000	0	RCF 300	0	Normal display contains an expanded number of settings visible during operation.
TIME 00:02:00	00:02:00	TEMP 20°C	+20	
PRG: --	11199/-----	PARAM+	MENU+	

Detailed information on display modes is provided in chapter *Types of main screen*.

<b>SPEED</b>	rotor speed	assigned/measured
<b>RCF</b>	relative centrifugal force	assigned/measured
<b>TIME</b>	centrifuging time	assigned/measured
<b>TEMP</b>	temperature	assigned/measured
<b>PRG</b>	program no.	
<b>11199</b>	rotor no.	
<b>PARAM</b>	parameters of the centrifuge	
<b>MENU</b>	configuration menu	



	changing values		
	user multi sections curve		
	density > 1,2 g/cm <sup>3</sup>		
	centrifuging radius changed		
	counting time down (decreasing)		counting time up (increasing)
	cooling to assigned temperature		
	FAST COOL mode cooling		
	centrifuging		centrifuging (with automatic cover opening)
	rotor stopped / closed cover		rotor stopped / opened lid
	braking		fastest decelerating
	rotor identification		
	thermal chamber		
	temperature delay		
	time delay		
	drop-down list		
	temporarily disabled		
	locked		
	time counting (blinking)		
	disabled option		active option

### 7.3 Setting up RPM, RCF, time, temperature



On the main screen, it is possible to set:

rotating speed - RPM	<b>SPEED</b>
relative centrifugal force (multiple of g-force)	<b>RCF</b>
centrifuging time	<b>TIME</b>
centrifuging temperature	<b>TEMP</b>



Exemplary change of **SPEED** setting:

	<ul style="list-style-type: none"> <li>▪ Press <b>SET</b> (to enter edit mode) –  appears.</li> <li>▪ Via <b>▲▼◀▶</b> keys mark <b>SPEED</b> field (blinking).</li> <li>▪ Press <b>SET-</b> blinking.</li> <li>▪ Via <b>◀▶</b> choose order of magnitude of changing value (blinking).</li> <li>▪ With <b>▲▼</b> choose demanded value.</li> <li>▪ Repeat above two steps for other orders of magnitude.</li> <li>▪ Confirm settings by pressing <b>SET</b>.</li> <li>▪ Press <b>BACK</b>.</li> </ul>
<ul style="list-style-type: none"> <li>▪ When RPM is changed, RCF is automatically corrected.</li> </ul>	

Exemplary change of **RCF** setting:



	<ul style="list-style-type: none"> <li>▪ Press <b>SET</b> (to enter edit mode) –  appears.</li> <li>▪ Via <b>▲▼◀▶</b> keys mark <b>RCF</b> field (blinking).</li> <li>▪ Press <b>SET-</b> blinking.</li> <li>▪ Via <b>◀▶</b> choose order of magnitude of changing value (blinking).</li> <li>▪ With <b>▲▼</b> choose demanded value.</li> <li>▪ Repeat above two steps for other orders of magnitude.</li> <li>▪ Confirm settings by pressing <b>SET</b>.</li> <li>▪ Press <b>BACK</b>.</li> </ul>
<ul style="list-style-type: none"> <li>▪ When RCF is changed, RPM is automatically corrected.</li> </ul>	

Exemplary change of **TIME** setting:

	<ul style="list-style-type: none"> <li>▪ Press <b>SET</b> (to enter edit mode) -  appears.</li> <li>▪ Via <b>▲▼◀▶</b> keys mark <b>TIME</b> field (blinking).</li> </ul>
---	---

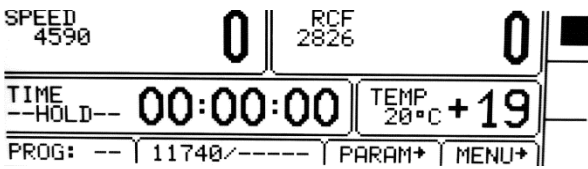
<p>00:02:00 [hh : mm : ss]</p> <p>e.g.:</p> <p>centrifuging time – 2 minutes 00 seconds</p>	<ul style="list-style-type: none"> <li>Press <b>SET</b>  blinking.</li> <li>Via <b>◀▶</b> choose order of magnitude of changing value (blinking).</li> <li>With <b>▲▼</b> choose demanded value.</li> <li>Repeat above two steps for other orders of magnitude.</li> <li>Confirm settings by pressing <b>SET</b>.</li> <li>Exit edit mode by pressing <b>BACK</b>.</li> </ul>
<p>00:02:00</p>	set value
<p>02:00</p>	current value (most significant digits)

<p><b>HOLD</b> mode</p>	<p>continuous run mode</p>
	<ul style="list-style-type: none"> <li>To run centrifuging in <b>HOLD</b> mode set <b>00:00:00</b> time.</li> <li>To end centrifuging in HOLD mode press <b>STOP</b>.</li> </ul>

<p>Exemplary change of <b>TEMP</b> setting:</p>	
	<ul style="list-style-type: none"> <li>Press <b>SET</b> (to enter edit mode) –  appears.</li> <li>Via <b>▲▼◀▶</b> keys mark <b>TEMP</b> field (blinking).</li> <li>Press <b>SET</b> key.</li> <li>With <b>▲▼</b> choose demanded value [-20°C÷40°C].</li> <li>Confirm settings by pressing <b>SET</b>.</li> <li>Press <b>BACK</b>.</li> </ul>

#### 7.4 Users programs

	<p>After switching centrifuge on, program that was used in previous session is being loaded. If any program was not used in previous session, centrifuge resume the last chosen parameters.</p>
---	---

<p><b>Program choosing:</b></p>	
<p>Entering the program selection mode for the <b>simplified display:</b></p>	

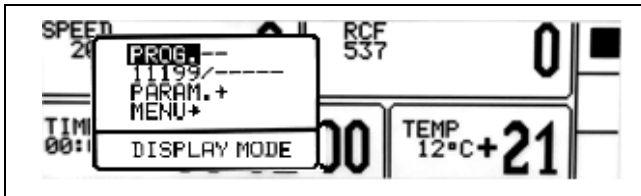

- Press and hold  by 1 second.
- Choose **PROG** with ▲▼
- Press **SET**.

Entering the program selection mode for the **normal display**:



- Press **SET** key –  appears.
- Via ▲▼◀▶ keys mark **PRG-** – field (highlighted)
- Press **SET** key – list of programs is visible.

**Program selection mode tab:**

No	SPEED	RCF	TIME	TEMP	ACC	DEC	ROT
0	4590	2826	HOLD	20	0	0	11740
1	4590	2826	00:01:00	20	0	0	11740
▶ 2	5090	3476	00:02:00	20	0	0	11740

- Via ▲▼ choose demanded program.
- Confirm with **SET** key.

No	SPEED	C	DEC	ROT
0	4590	0	0	11740
1	4590	0	0	11740
▶ 2	5090	0	0	11740

LOAD  
 SAVE  
 DELETE  
 CURVES  
 -----  
 NEW PROGRAM

**LOAD, SAVE, DELETE, NEW PROGRAM** refers chosen program which is marked by ▶.

▶ - program currently selected

No	SPEED	C	DEC	ROT
0	4590	0	0	11740
1	4590	0	0	11740
▶ 2	5090	0	0	11740

SAVE ?  
 -----  
 YES  
 NO

**LOAD** - loading the selected program

**SAVE** – save settings as a program (confirm by selecting **YES** and pressing **SET**)

No	SPEED	C	DEC	ROT
0	4590	0	0	11740
1	4590	0	0	11740
▶ 2	5090	0	0	11740

DELETE ?  
 -----  
 YES  
 NO

**DELETE** – delete program (confirm by selecting **YES** and pressing **SET**)

No	SPEED	C	DEC	ROT
0	4590	0	0	11740
1	4590	0	0	11740
▶ 2	5090	0	0	11740

LOAD  
 SAVE  
 DELETE  
 CURVES  
 -----  
 NEW PROGRAM

**NEW PROGRAM**– enter to create new program mode (as below)

**Creating a new program:**

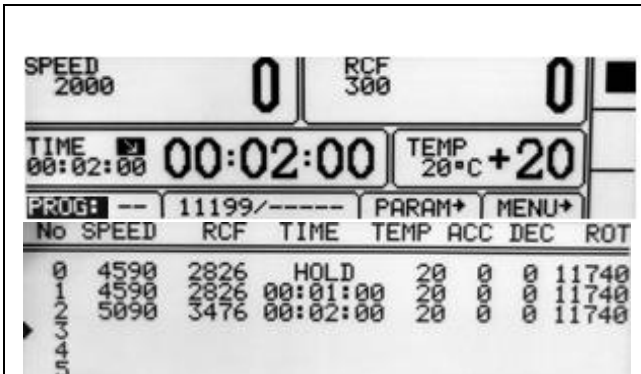

- Press **SET** key.
- Via ▲▼◀▶ keys mark **PROG** field (blinking).
- Press **SET** key. List of programs is visible, choose demanded position (number of program).

<pre> No SPEED 0 4590 1 4590 2 5090 ▶ 5144UN3 5 </pre>	<pre> LOAD SAVE DELETE CURVES ----- NEW PROGRAM </pre>	<pre> C DEC ROT 0 0 11740 0 0 11740 0 0 11740 </pre>	<ul style="list-style-type: none"> <li>Press <b>SET</b> key- menu of program settings will appear.</li> <li>Choose <b>NEW PROGRAM</b> press <b>SET</b> and <b>BACK</b>, and then set demanded parameters of centrifuging (look chapter <b>Centrifuging</b>).</li> <li>In case you want to register new program, back to the <b>PROG</b> menu and save it as described before.</li> </ul>
--	--	--	--

### Changing parameters during centrifuging

There is a possibility to change parameters: **SPEED, RCF, TIME, TEMP** during centrifuging. Such modifications inactivate currently running program. When program was set, modification during run is represented by **PROG --** symbol (instead of the program number).

### 7.5 Creator of acceleration and deceleration curves

								PROG/CURVES
<pre> No SPEED RCF TIME TEMP ACC DEC ROT 0 4590 2826 HOLD 20 0 0 11740 1 4590 2826 00:01:00 20 0 0 11740 ▶ 2 5090 3476 00:02:00 20 0 0 11740 5144UN3 5 </pre>								<ul style="list-style-type: none"> <li>With <b>▲▼</b> keys choose saved program for which you intend to create the acceleration or deceleration characteristics (marked with symbol ▶).</li> <li>Press <b>SET</b>.</li> <li>With <b>▲▼</b> keys choose <b>CURVES</b>.</li> <li>Press <b>SET</b> - the selection frame is displayed.</li> </ul>
<pre> No SPEED 0 4590 1 4590 ▶ 2 5090 5144UN3 5 </pre> <pre> LOAD SAVE DELETE CURVES ----- NEW PROGRAM </pre>								
<pre> No SPEED 0 4590 1 4590 ▶ 2 5090 5144UN3 5 </pre>	<pre> PROGRAM: 2 CURVES ----- ACCELERATION DECCELERATION </pre>							<ul style="list-style-type: none"> <li>With <b>▲▼</b> keys choose <b>ACCELERATION</b> to create acceleration characteristics or <b>DECCELERATION</b> to create deceleration characteristics</li> <li>Confirm selection by pressing <b>SET</b>.</li> </ul>

### 7.5.1 Acceleration characteristic, Creation of episode 1

<p><b>SPEED or 4000 displayed (example):</b></p> <table border="1"> <thead> <tr> <th>No</th> <th>TIME</th> <th>SPEED</th> </tr> </thead> <tbody> <tr> <td>1</td> <td>0:00:11</td> <td>4000</td> </tr> </tbody> </table>	No	TIME	SPEED	1	0:00:11	4000	<b>No</b>	section no. (max. 4)
	No	TIME	SPEED					
	1	0:00:11	4000					
	<b>TIME</b>	total acceleration time						
	<b>SPEED</b>	final RPM						
	<b>ACC</b>	characteristic's no. (10-19)						
		adding a new section						
		deleting last section						
	editing sections							
	exiting from characteristics wizard							
	switching RPM/RCF							

After entering the curve wizard, the symbol is highlighted. Pressing **SET** and selecting "NO" in response to the question "SAVE?" will return to the **PROG → CURVES** menu without making changes to the starting characteristics. To start editing the one-segment characteristics, select the icon with the **◀▶** keys and press the **SET** key.

		editing value (flashing means editing the given value)
	<ul style="list-style-type: none"> <li>Press <b>SET</b></li> <li>With <b>▲▼◀▶</b> choose time for section</li> <li>Press <b>SET</b></li> <li>It is not possible to edit the maximum speed value. To do this, more sections have to be created, but the last section will always have the maximum set speed and cannot be changed.</li> <li>Select  with <b>▼◀</b> buttons and press <b>SET</b> to finish editing characteristics.</li> </ul>	

### 7.5.2 Adding and editing sections - acceleration

To program next sections, select the icon with the **◀▶** buttons and press **SET**. A new section (sections) will appear with a time of 1 second and a speed equal to the maximum speed.

To start editing a newly added section (sections), select the icon with the **◀▶** buttons and press **SET**, and follow the instructions given below.

After entering the profile section editing menu, the time value of the first section will be highlighted (see the picture below).

	The maximum speed value for the section cannot be higher than the maximum speed value for the characteristic (for the last section).	
	<ul style="list-style-type: none"> <li>With <b>▲▼◀▶</b> highlight time or speed for desired section</li> </ul>	

	<ul style="list-style-type: none"> <li>▪ Press <b>SET</b></li> <li>▪ With ▲▼◀▶ choose value</li> <li>▪ Press <b>SET</b></li> <li>▪ Repeat until setting all the sections</li> <li>▪ To finish editing characteristic with ▲▼◀▶ choose ↻ and press <b>SET</b>. Finishing edition can be also done by pressing <b>BACK</b> button</li> </ul>
--	--

<b>Saving created characteristic</b>	
	<ul style="list-style-type: none"> <li>▪ Select the ↻ icon with the ◀▶ buttons and press <b>SET</b></li> <li>▪ In the "Save?" window, use ▲▼ buttons to select YES to confirm saving the characteristic or NO, to exit without saving</li> <li>▪ Press <b>SET</b></li> </ul>

### 7.5.3 Acceleration graph

<i>An example of given parameters and a graph:</i>	
	<p>After programming the time and / or speed values, the segment (all segments) is graphically displayed on the graph on the right side of the screen. The time value is on the horizontal axis of the user's starting characteristic, while the speed is on the vertical axis.</p>

### 7.5.4 Deceleration characteristic – creating section 1

<p><b>SPEED</b> or <b>4000</b> displayed (example):</p>	<b>NO</b>	section no. (max. 4)
	<b>TIME</b>	total acceleration time
	<b>SPEED</b>	final RPM
	<b>DEC</b>	characteristic's no. (10-19)
	+	adding a new section
	-	deleting last section
	✎	editing sections
	↻	exiting from characteristics menu
	↺	switching RPM/RCF

After entering the curve wizard, the symbol ↻ is highlighted. Pressing **SET** and selecting "NO" in response to the question "SAVE?" will return to the **PROG → CURVES** menu without making changes to the starting characteristics. To start editing the one-segment characteristics, select the icon ✎ with the ◀▶ keys and press the **SET** key.

	<div style="border: 1px solid black; padding: 5px; margin-bottom: 10px;">  editing value (flashing means editing the given value)         </div> <ul style="list-style-type: none"> <li>▪ Press <b>SET</b></li> <li>▪ With ▲▼◀▶ choose time for section</li> <li>▪ Press <b>SET</b></li> <li>▪ To edit speed</li> <li>▪ It is not possible to edit the minimum speed value. To do this, more legends must be created, but the last leg will always be "0".</li> <li>▪ Select ↻ with ▼◀ buttons and press <b>SET</b> to finish editing characteristics</li> </ul>
--	--

**7.5.5 Adding and editing sections - deceleration**

In order to program successive periods, select the icon ⊕ with the ◀▶ keys and press the **SET** key. A new segment (or segments - after successive presses of SET) will appear with the time and speed equal to the minimum speed - "0".

To start editing the newly added sections, select the icon ✎ with the ◀▶ buttons, press **SET** and make the settings as described below.

After entering the profile section editing menu, the time value of the first section will be highlighted (see the picture below).

	<p>The speed value of the last segment will always be "0"</p> <ul style="list-style-type: none"> <li>▪ With ▲▼◀▶ highlight time or speed for desired section</li> <li>▪ Press <b>SET</b></li> <li>▪ With ▲▼◀▶ choose value</li> <li>▪ Press <b>SET</b></li> <li>▪ Repeat until setting all the sections</li> <li>▪ To finish editing characteristic with ▲▼◀▶ choose ↻ and press <b>SET</b>. Finishing edition can be also done by pressing <b>BACK</b> button</li> </ul>
--	---

**Saving created characteristic**

	<ul style="list-style-type: none"> <li>▪ Select the ↻ icon with the ◀▶ buttons and press <b>SET</b></li> <li>▪ In the "Save?" window, use ▲▼ buttons to select YES to confirm saving the characteristic or NO, to exit without saving</li> <li>▪ Press <b>SET</b></li> </ul>
--	--

**7.5.6 Deceleration graph**

*An example of given parameters and a graph:*

	<p>After programming the time and / or speed values, the segment (all segments) is graphically displayed on the graph on the right side of the screen. The time value is on the horizontal axis of the user's braking characteristic, while the speed is on the vertical axis.</p>
--	--





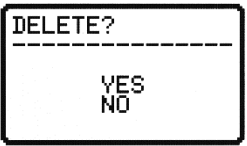

### 7.5.7 Deleting sections

In the characteristic's wizard:

No	TIME
1	0:00:11
2	0:00:01
3	0:00:01



- Select the  icon with the   buttons and press **SET**
- In the "Delete?" window, use   buttons to select YES to confirm deleting the characteristic section or NO to cancel
- Press **SET**

### 7.6 Programs with user characteristics

Loading a modified program in the **CURVES** fold is signaled by the icon on the main screen:







Icon  signals that program with user acceleration/deceleration characteristics are loaded.

A change in any parameter entails the deactivation of the multi-section's curves mode.

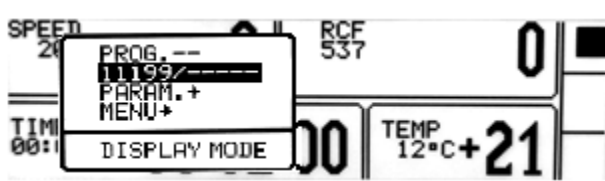
### 7.7 Rotor choosing

**Simplified display mode**









- Press and hold  by 1 second.
- Choose rotor number (exemplary 11199/-----) with  .
- Press **SET**.
- Execute points described follow (below **Normal display mode** description)

**Normal display mode**





NO	ROTOR	BUCKET	SPEED	RCF	RMAX	RMIN
1	11199	-----	18000	24270	67	35
2	11210	-----	5000	3997	143	60
3	11211	-----	5500	4498	133	87
4	11213	-----	5500	4227	125	79
5	11259	-----	15000	24400	97	65
6	11273	-----	12000	14006	87	54

- Press **SET** -  appears.
- Via     mark rotor choosing field.
- Press **SET** (Rotor list will appear).
- Via   keys mark demanded rotor number
- Confirm by press **SET**.
- Press **BACK**.

It is possible to set **AUTOMATIC ROTOR IDENTIFICATION**.  
The procedure is described in subsection *Others*.

### 7.8 SHORT mode



- The **SHORT** mode is activated by pressing and holding  (**SHORT**).

In **SHORT** mode the centrifuge is working as long as the **SHORT** key is pressed or when set time is over.

## 7.9 Finishing the centrifuging

	When preselected time is reached, centrifugation will end automatically.
	<ul style="list-style-type: none"> <li>Before lapse preselected time one may stop centrifugation. Pressing <b>STOP</b> for the first time will stop centrifuging with the characteristic set in loaded program. ↓ symbol will be shown.</li> </ul>
	<ul style="list-style-type: none"> <li>Pressing <b>STOP</b> second time will stop centrifuging with the fastest characteristic. ↓ symbol will be shown.</li> </ul>
	<ul style="list-style-type: none"> <li>The message about cancel of centrifuging can be delete with the <b>STOP, SET, COVER, ▲▼◀▶</b> or <b>BACK</b> key.</li> </ul>

## 7.10 Temporarily disabled functions

Functions written below can be temporarily disabled.

	SPEED	RCF	TIME	TEMP	PROG —	— / — —	PARAM	MENU
THERMAL CHAMBER	●	●	●	○	●	●	●	●
STANDARD CENTRIFUGING	●	●	●	●	●	○	●	○

● available

○ disabled

## 8. Temperature control

	MPW-380R only
--	---------------

Centrifuge is equipped with ecological refrigerating system with temperature control. During centrifugation, there may appear differences in temperature on the display and temperature of the samples in the rotor. It depends on thermal conductivity of the rotor, and samples and centrifugation time, initial temperature of rotor and samples.

Exemplary change of **TEMP** setting:

	<ul style="list-style-type: none"> <li>Press <b>SET</b> (to enter edit mode)  – appears.</li> <li>Via <b>▲▼◀▶</b> keys mark <b>TEMP</b> field (blinking).</li> <li>Press <b>SET</b> key.</li> <li>With <b>▲▼</b> choose demanded value (from -20°C to 40°C).</li> <li>Confirm settings by pressing <b>SET</b>.</li> <li>Press <b>BACK</b>.</li> </ul>
--	---

	<p>Cooling is indicated by a symbol  (blinking).</p>
--	--

### 8.1 Initial cooling during centrifuging –FAST COOL

	<p>The parameters allowable to change at <b>FAST COOL</b> mode:</p> <ul style="list-style-type: none"> <li>temperature (lower than current temperature shown by centrifuge)</li> </ul> <ul style="list-style-type: none"> <li>In order to centrifuging reduced temperature samples (eg. storage in the external refrigerator) centrifuge chamber, rotor and centrifuge container must be pre-cooling to the predetermined temperature. It causes minimalization of temperature differences.</li> <li>Initial cooling may be activated by <b>FAST COOL</b> key (lid must be closed – rotor is spinning at <b>FAST COOL</b> mode)</li> <li>When <b>FAST COOL</b> mode is active, cooling system automatically set proper parameters to obtain demanded temperature the fastest way.</li> </ul>
--	--

	<p><b>FAST COOL</b> mode is marked by symbol  blinking in the right upper side of display.</p>
	<p>It is possible to exit <b>FAST COOL</b> mode at any time by pressing <b>STOP</b> key. Interruption of the function is signaled by a message.</p>

### 8.2 Initial cooling or heating without centrifuging – THERMAL CHAMBER

	<p style="text-align: right;">PARAM → <b>THERMAL CHAMBER</b></p> <ul style="list-style-type: none"> <li>There is possible to run centrifuge in <b>THERMAL CHAMBER</b> mode - cooling for R (rotor is at standstill).</li> <li>How to enable <b>THERMAL CHAMBER</b> is described in Parameters of centrifugation chapter.</li> </ul>
--	---

### 8.3 Cooling or heating in "START DELAY – OF TEMPERATURE" mode

	PARAM → START DELAY – OF TEMPERATURE
	<ul style="list-style-type: none"> <li>Centrifuging process will start, when preselected temperature is reached.</li> <li>How to enable run <b>START DELAY – OF TEMPERATURE</b> function is described in Parameters of centrifugation chapter.</li> </ul>



### 8.4 Cooling or heating in „SHORT" mode

	<ul style="list-style-type: none"> <li>Cooling and heating features are available in SHORT mode.</li> <li>How to enable run centrifugation in <b>SHORT mode</b> is described in <i>Centrifugation/SHORT mode</i>.</li> </ul>
---	--

### 8.5 Cooling and heating notes

Centrifuges with cooling (MPW-380R) are equipped with an efficient cooling system. It allows obtaining selected temperatures in the chamber even at maximum spin speed or fast obtaining desired temperatures (e.g., 4°C and 36°C). Note that time and possibility of obtaining a set temperature is dependent on multiple factors, including: the power of the cooling system, the shape of the rotor, the rotor speed, ambient temperature, etc. The accuracy of the temperature stability of  $\pm 1^\circ\text{C}$  is determined by the installation place of the temperature sensor.

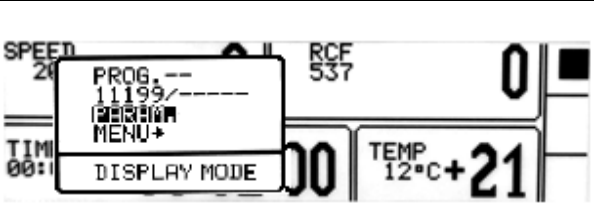
## 9. Parameters of centrifugation

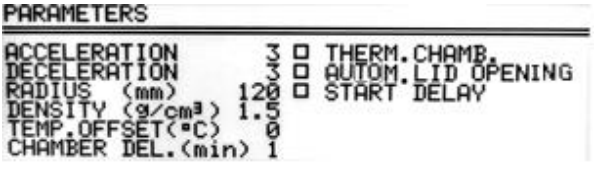

<b>Simplified display</b>	
	<ul style="list-style-type: none"> <li>Press and hold  by 1 second.</li> <li>Choose <b>PARAM.</b> with ▲ ▼</li> <li>Press <b>SET.</b></li> </ul> <p>Execute points described follow (below <b>Normal display mode</b> description)</p>
<b>Normal display</b>	
	<ul style="list-style-type: none"> <li>Press <b>SET.</b></li> <li>With ▲ ▼ ◀ ▶ keys select <b>PARAM.</b></li> <li>Press <b>SET.</b></li> </ul>
	

<b>ACCELERATION</b>	chosen acc. characteristic (0-the fastest, 9-the slowest)
<b>DECELERATION</b>	chosen dec. characteristic (0-the fastest, 9-the slowest)
<b>RADIUS [mm]</b>	current rotor radius [mm]
<b>DENSITY (g/cm<sup>3</sup>)</b>	sample density [g/cm <sup>3</sup> ]
<b>TEMP. OFFSET (°C)</b>	value of temperature correction
<b>CHAMBER DEL. (min)</b>	delay between set thermal chamber mode and start it
<b>THERMAL CHAMBER</b>	cooling of the chamber without centrifuging
<b>AUTOM. LID OPENING</b>	opening cover after centrifuging automatically
<b>START DELAY</b>	starting delayed (after pressing START)

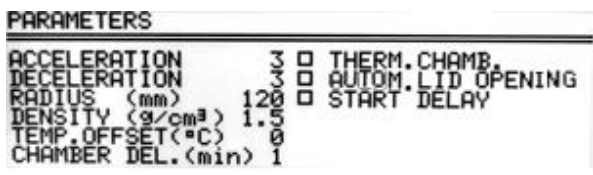

### 9.1 Acceleration/deceleration – changing characteristics

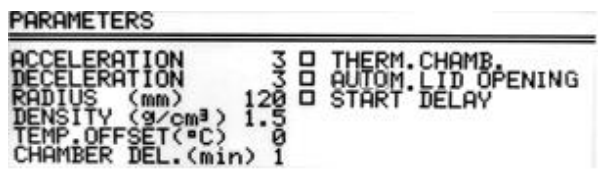
 <pre> PARAMETERS ----- ACCELERATION      3  <input type="checkbox"/> THERM.CHAMB. DECELERATION      3  <input type="checkbox"/> AUTOM.LID OPENING RADIUS (mm)       120 <input type="checkbox"/> START DELAY DENSITY (g/cm³)   1.5 TEMP.OFFSET(°C)   0 CHAMBER DEL.(min) 1           </pre>	<ul style="list-style-type: none"> <li>▪ With ▲▼ keys select <b>ACCELERATION</b> or <b>DECELERATION</b>.</li> <li>▪ Press <b>SET</b>.</li> <li>▪ With ▲▼ keys select demanded number of characteristic.</li> <li>▪ Press <b>SET</b>.</li> </ul> <p><b>ACCELERATION</b> –10 (0 ÷ 9), linear accelerating characteristics assigned to every rotor. 0-the fastest acceleration, 9-the slowest acceleration.</p> <p><b>DECELERATION</b> – 10 (0 ÷ 9), linear decelerating characteristics assigned to every rotor. 0-the fastest deceleration, 9-the slowest deceleration.</p>
---	--

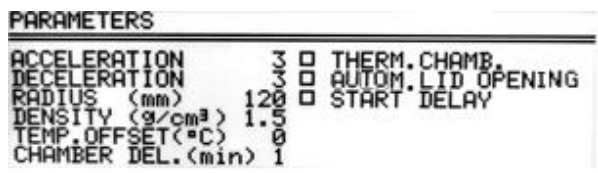

### 9.2 Radius

 <pre> PARAMETERS ----- ACCELERATION      3  <input type="checkbox"/> THERM.CHAMB. DECELERATION      3  <input type="checkbox"/> AUTOM.LID OPENING RADIUS (mm)       120 <input type="checkbox"/> START DELAY DENSITY (g/cm³)   1.5 TEMP.OFFSET(°C)   0 CHAMBER DEL.(min) 1           </pre>	<p><b>RADIUS [mm]</b> - control of the radius of the rotor within the range from <math>R_{min}</math> to <math>R_{max}</math>. Available values depends on chosen rotor. Radius correction serve for more precise control RCF, exemplary when user need to know real RCF in half length of test tube.</p> <p>To change the rotor radius:</p> <ul style="list-style-type: none"> <li>▪ select <b>RADIUS [mm]</b> with ▲▼ keys.</li> <li>▪ Press <b>SET</b>.</li> <li>▪ Set demanded value by pressing ▲▼.</li> <li>▪ Press <b>SET</b>.</li> </ul>
	<p>When radius correction is activated, <b>R</b> symbol is visible on the screen.</p> <p>Reducing of the rotor radius resulting change of displayed RCF value.</p>

### 9.3 Sample density

 <pre> PARAMETERS ----- ACCELERATION      3  <input type="checkbox"/> THERM.CHAMB. DECELERATION      3  <input type="checkbox"/> AUTOM.LID OPENING RADIUS (mm)       120 <input type="checkbox"/> START DELAY DENSITY (g/cm³)   1.5 TEMP.OFFSET(°C)   0 CHAMBER DEL.(min) 1           </pre>	<p><b>DENSITY (g/cm³)</b> – default density is set to <b>1,2 g/cm³</b></p> <p>To change the density (possible values <b>1,2÷9,9 g/cm³</b>):</p> <ul style="list-style-type: none"> <li>▪ Via ▲▼ keys select <b>DENSITY (g/cm³)</b></li> <li>▪ Press <b>SET</b>.</li> <li>▪ Set demanded value by pressing ▲▼.</li> <li>▪ Press <b>SET</b>.</li> </ul>
	<p>When density is changed, <b>D</b> symbol is visible on the screen.</p> <p>Changing of <b>DENSITY</b> value is obligatory when density of sample placed into rotor is higher than <math>1.2 \text{ g/cm}^3</math>.</p> <p><b>Change of DENSITY value led to decreasing maximum value of accessible speed.</b></p>

## 9.4 Temperature offset



	MPW-352R only
<p>PARAMETERS</p> <pre> ACCELERATION      3  <input type="checkbox"/> THERM. CHAMB. DECELERATION      3  <input type="checkbox"/> AUTOM. LID OPENING RADIUS (mm)       120 <input type="checkbox"/> START DELAY DENSITY (g/cm³)   1.5 TEMP. OFFSET(°C)  0 CHAMBER DEL.(min) 1           </pre>	<p>Temperature offset serve for more precise control of real sample temperature. It can be helpful in case high/low initial temperature samples or high volume samples.</p> <ul style="list-style-type: none"> <li>With ▲ ▼ keys select <b>TEMP. OFFSET</b>.</li> <li>Press <b>SET</b>.</li> <li>Use the ▲ ▼ keys to select the difference between the temperature that the cooling system will aim for, and set temperature. Confirm selection by pressing <b>SET</b>.</li> </ul> <p><b>Attention!</b> The use of the offset can not extend the temperature range achieved by the centrifuge.</p> <p><b>Function description</b> At a set temperature of 20°C and the set offset value equal to -5°C, cooling system will actually strive to reach 15°C. With a setpoint temperature of 20°C and a set offset value of 5°C the system will actually try to reach 25°C.</p> <p>The temperature displayed on the main screen is corrected for offset value.</p> <p>Offset can be selected range from -20°C to 20°C.</p>
	<p>Activation of the function is signaled on the main screen with  or  depending on the offset value sign.</p>

## 9.5 Thermal chamber

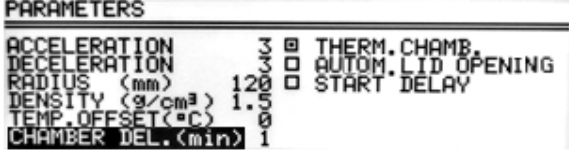
	MPW-380R only
<p>Cooling without centrifuging.</p> <p>PARAMETERS</p> <pre> ACCELERATION      3  <input type="checkbox"/> THERM. CHAMB. DECELERATION      3  <input type="checkbox"/> AUTOM. LID OPENING RADIUS (mm)       120 <input type="checkbox"/> START DELAY DENSITY (g/cm³)   1.5 TEMP. OFFSET(°C)  0 CHAMBER DEL.(min) 1           </pre>	<p style="text-align: right;"><b>THERMAL CHAMBER</b></p> <ul style="list-style-type: none"> <li>With ▲ ▼ ◀ ▶ keys select <b>THERMAL CHAMBER</b>.</li> <li>Press <b>SET</b> (to turn on/off).</li> <li>With ▲ ▼ keys select temperature value.</li> <li>Set demanded value (0°C÷40°C) by pressing ▲ ▼. Confirm selection by pressing <b>SET</b>.</li> <li>Attention, do not set the thermal chamber to a value higher than currently indicated by the centrifuge.</li> </ul>

	<ul style="list-style-type: none"> <li>When THERMAL CHAMBER function is activated, <b>T</b> symbol is visible on the screen.</li> <li>Changing temperature from the main screen is not possible.</li> <li>Opening cover terminates THERMAL CHAMBER function (closing cover back turns it on).</li> </ul>
	<p>Thermal chamber is activated with delay. Set time of delaying by select <b>CHAMBER DEL.</b></p> <ul style="list-style-type: none"> <li>Press <b>SET</b>.</li> <li>With <b>▲▼</b> keys select demanded value (1-5 min).</li> <li>Press <b>SET</b>.</li> </ul>
<ul style="list-style-type: none"> <li>The function is activated automatically after confirmation and with the lid closed. When the lid is opened, the function is interrupted, and when the lid is closed again, the function resumes. If the <b>THERMAL CHAMBER</b> function is enabled during the centrifugation cycle, at the end of this cycle, the <b>THERMAL CHAMBER</b> function is activated until the lid is opened.</li> <li>Contrary to other parameters, the <b>THERMAL CHAMBER</b> function can be turned on only when the centrifuge is stopped.</li> </ul>	

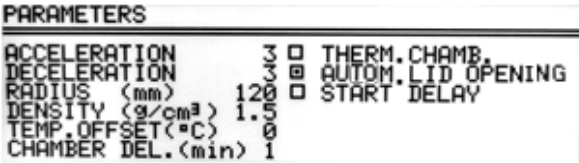
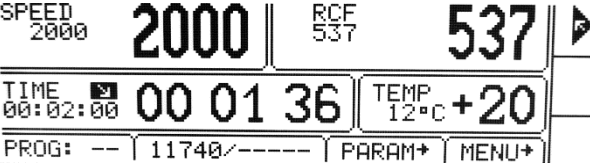
### 9.6 Automatic lid opening

<p>Automatic lid opening</p>	<p style="text-align: center;"><b>AUTOMATIC LID OPENING</b></p>
	<ul style="list-style-type: none"> <li>When centrifuge process is finished, cover will be opened automatically for set option AUTOM. LID OPENING.</li> <li>When centrifuging is terminated by pressing <b>STOP</b>, opening cover is possible by pressing <b>COVER</b>.</li> </ul>
	<ul style="list-style-type: none"> <li> symbol means that OPEN LID AFTER RUN is active.</li> </ul>

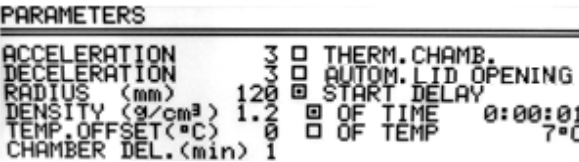

### 9.7 Start delay - of time

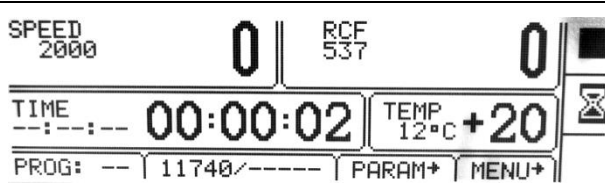
	<p>Start centrifuging since reselected delay is reached.</p>	<p style="text-align: center;"><b>STARY DELAY / OF TIME</b></p>
		<ul style="list-style-type: none"> <li>With <b>▲▼</b> keys select <b>START DELAY</b>. Press <b>SET</b>.</li> <li>Start delay can be set from 0 : 0 0 : 0 1 to 9 : 5 9 : 5 9.</li> <li>With <b>▲▼</b> keys select <b>OF TIME</b>. Press <b>SET</b> and <b>▶</b> and then <b>SET</b>.</li> <li>With <b>▲▼</b> keys set demanded value.</li> <li>Confirm by pressing <b>SET</b>.</li> <li>Press <b>BACK</b> to escape edit mode.</li> </ul>

	When START DELAY function is activated, symbol is visible on the screen.
START DELAY / <b>OF TIME</b> function cannot be run when START DELAY / <b>OF TEMP</b> is activated.	

## 9.8 Start delay – of temperature

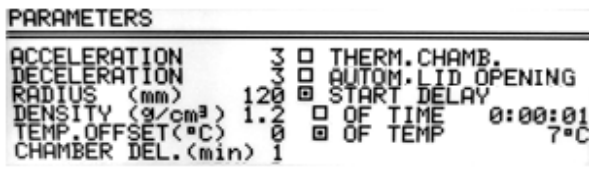
	<b>MPW-380R</b> only
---	----------------------

	Start centrifuging time counting since preselected temperature is reached.	START DELAY / <b>OF TEMP.</b>
	<ul style="list-style-type: none"> <li>With ▲▼◀▶ keys mark <b>START DELAY</b>.</li> <li>Press <b>SET</b>.</li> <li>With ▲▼◀▶ keys mark <b>OF TEMP</b>.</li> <li>Press <b>SET</b>.</li> <li>Press ▶, press <b>SET</b>.</li> <li>With ▲▼ keys set demanded value of temperature.</li> <li>Press <b>SET</b>.</li> <li>Exit edit mode by press <b>BACK</b>.</li> </ul>	
	When START DELAY – OF TEMPERATURE is turned on,  symbol is visible on the screen.	
When the function is active, the speed can be reduced to the optimum values for the <b>FAST COOL</b> function, when the set speed is lower than the optimum value, the rotor rotates at the set by user speed.		
START DELAY / <b>OF TEMP.</b> function cannot be run when START DELAY / <b>OF TIME</b> is activated.		

## 9.9 Printing report (USB)

When the centrifuging process is finished there is a possibility to obtain report. Report can be transferred to PC or printed.

### PC (USB)

The elements needed to make connecting your computer via USB:

name	quantity (pcs.)	cat. No.
USB A-A cable	1	16655
<b>MPW Editor 2</b> application	1	to downloaded from the website: <a href="http://www.mpw.pl">www.mpw.pl</a>

Operating System Requirements: **Microsoft Windows 10 (64bit)**.

The Manufacturer does not guarantee that the program will work correctly with other operating systems.

### Preparation

- Download installation file from website at **www.mpw.pl**.
- Unzip the file and run **setup.exe**.
- Install **MPW Editor 2** application on the computer, press **Install**.



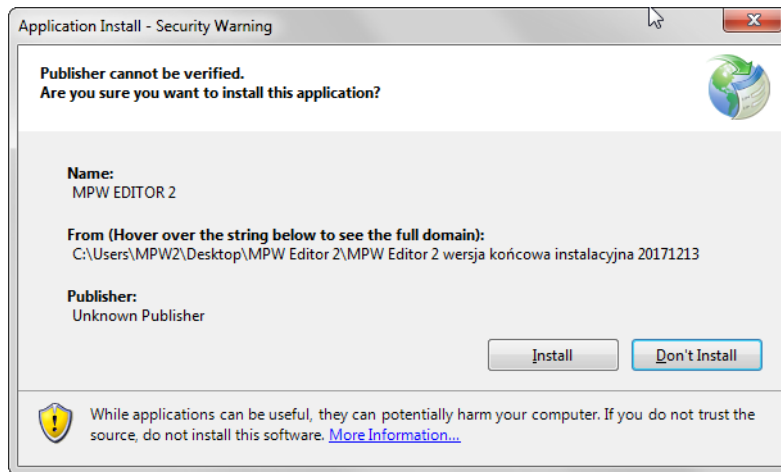

- If necessary install **FTDI USB drivers** and **.NET Framework 4.0** library (download with manufacturer's website: [www.mpw.pl](http://www.mpw.pl)).

### Centrifuging and printing

- Run **MPW Editor 2** application.
- Choose **Język\English**

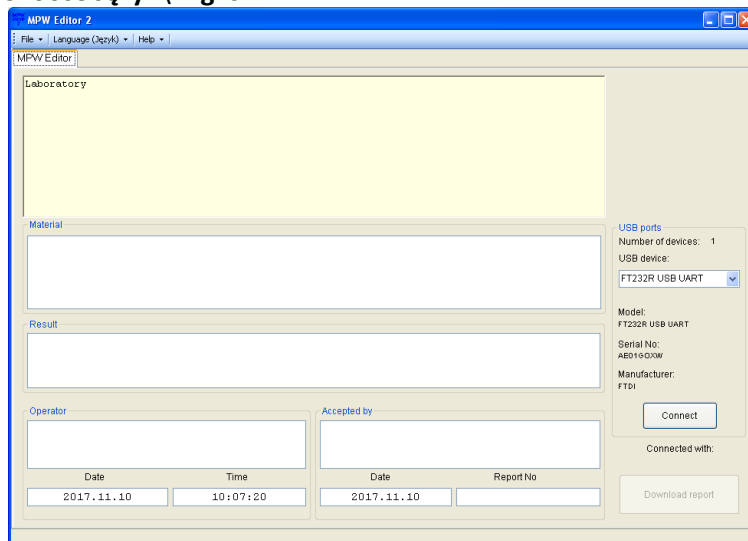

- Connect centrifuge to the PC in accordance with the „Connection scheme”
- Choose port assigned to the centrifuge (it will appear after connecting USB cable).

**Attention:**

If the interface has not been programmed: name, serial number and manufacturer's name, the device will be identified by Windows and MPW Editor 2 with the data programmed by FTDI (manufacturer USB integrated circuit) for example FT232R USB UART.

- **Choose File\Edit form**

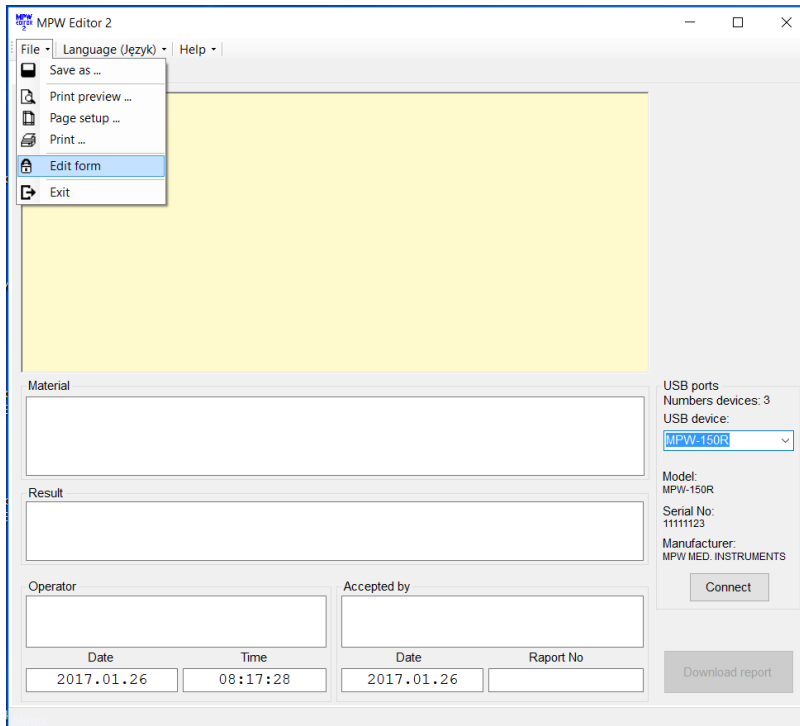

- In the „Tytuł (Title)” field, you can place any text, for example name of the laboratory, for later use in the report template.

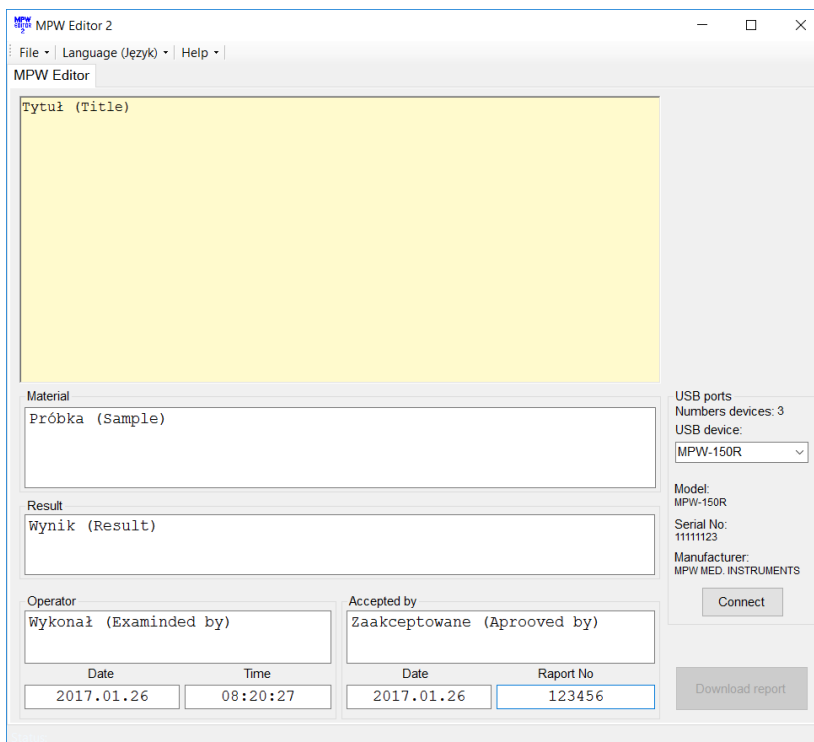

- **Choose File\Save form.**
- Ensure that USB device is selected from the list of devices.
- Press **Connect**. After successful communication, "PC" appears in the display.

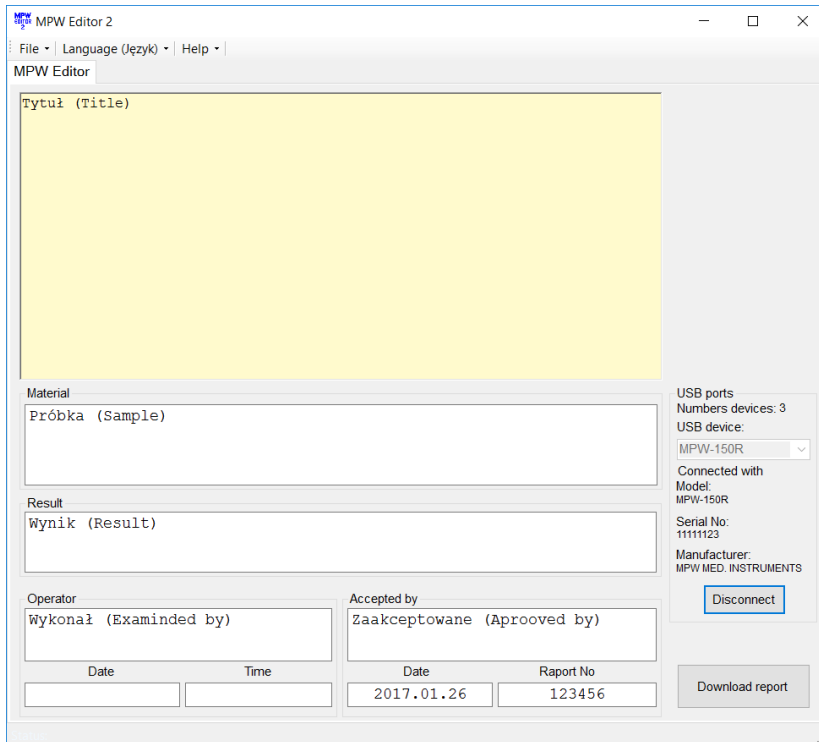

- Fill folds: „Material”, „Result”, „Operator”, „Accepted by”, „Raport no” (optionally).
- When the centrifuging process is finished, press **Download the report**.
- When centrifuging process is completed, report will appear.
- Save report (**File/Save as**) or print it (**File/Print**).
- In order to get another report, press New test and press Download the report.
- After finishing the work, press **Disconnect** button (the "PC" disappears from the display of the centrifuge) and then closes MPW Editor 2.

### Connection diagram

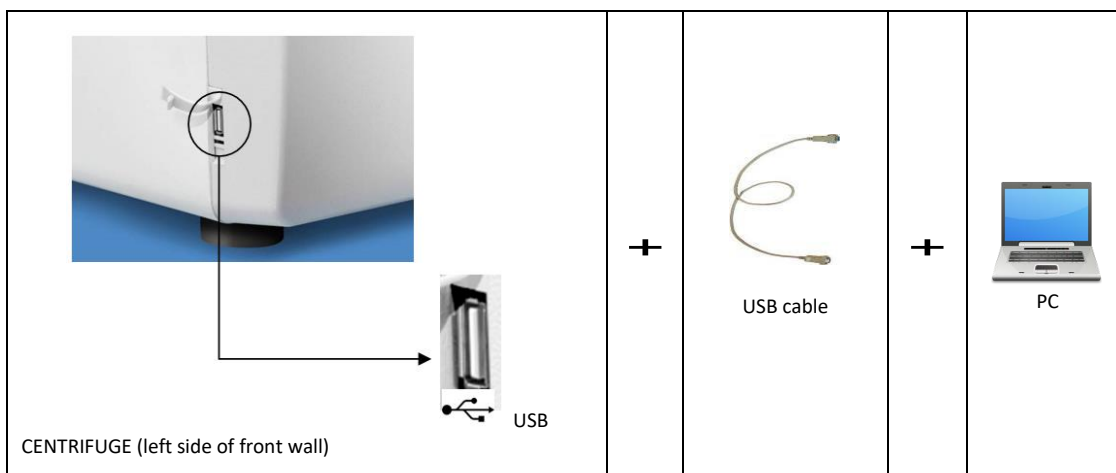

## 10. Menu

Simplified display									
	<ul style="list-style-type: none"> <li>Press and hold  by 1 second.</li> <li>Choose <b>MENU</b> with ▲▼</li> <li>Press <b>SET</b>.</li> </ul> <p>Execute points described follow (below <b>Normal display mode</b> description)</p>								
Normal display									
	<ul style="list-style-type: none"> <li>Press <b>SET</b>.</li> <li>With ▲▼◀▶ keys select <b>MENU</b>.</li> <li>Press <b>SET</b>.</li> </ul>								
<p style="text-align: center;">MENU</p> <hr/> <table style="width: 100%; border: none;"> <tr> <td style="width: 50%;">CONFIGURATION</td> <td style="width: 50%;">ROTOR RUNTIME</td> </tr> <tr> <td>PASSWORD</td> <td>CONTACT US</td> </tr> <tr> <td>LAST 10 CYCLES</td> <td>DIAGNOSTICS</td> </tr> <tr> <td>WORK TIME</td> <td>FACTORY SETTINGS</td> </tr> </table>	CONFIGURATION	ROTOR RUNTIME	PASSWORD	CONTACT US	LAST 10 CYCLES	DIAGNOSTICS	WORK TIME	FACTORY SETTINGS	<ul style="list-style-type: none"> <li>To navigate in <b>MENU</b> use ▲▼◀▶ keys.</li> <li>To enter menu press <b>SET</b>.</li> </ul>
CONFIGURATION	ROTOR RUNTIME								
PASSWORD	CONTACT US								
LAST 10 CYCLES	DIAGNOSTICS								
WORK TIME	FACTORY SETTINGS								

CONFIGURATION	centrifuge configuration
PASSWORD	password protection
LAST 10-CYCLES	10 last centrifugation cycles history
CYCLES	total working time of centrifuge, total number of working cycles counter
ROTOR RUNTIME	counting time of work and cycles amount for each rotor
CONTACT US	manufacturer's details
DIAGNOSTICS	error codes (service field)
FACTORY SETTINGS	restore factory settings

### 10.1 Screen saver

Setting time of screen saver	MENU/ CONFIGURATION / <b>SCREEN</b>
	<ul style="list-style-type: none"> <li>With ▲▼◀▶ keys select <b>SCREENSAVER</b>.</li> <li>Press <b>SET</b> and then ▼ and <b>SET</b>.</li> <li>With ▲▼ keys select demanded value from 1 to 60 minutes.</li> <li>Mark selection by pressing <b>SET</b>.</li> <li>Leave the menu by pressing <b>BACK</b>.</li> </ul>

### 10.2 Visual alarm

Visual alarm	MENU/CONFIGURATION/ <b>SCREEN</b>
	<ul style="list-style-type: none"> <li>Via ▲▼ keys choose <b>VISUAL ALARM</b></li> <li>Mark it by pressing <b>SET</b>.</li> </ul> <p><b>VISUAL ALARM</b> cause blinking screen after ending of centrifuging or after message occurring.</p>

### 10.3 Types of main screen

To ensure optimal adaptation to the user's preferences, work is possible in two basic screen modes.

**NORMAL DISPLAY** - contains an expanded number of parameters visible on the display.

**SIMPLIFIED DISPLAY** - contains only the most important parameters visible on the display.

For each of the above modes, you can choose priority RPM display or RCF.

By default, the **SIMPLIFIED DISPLAY** is set

Types of main screen	
<b>NORMAL DISPLAY</b>	<b>SIMPLIFIED DISPLAY</b>
Switch between the <b>SPEED</b> (RPM) and <b>RCF</b> display priority modes	
<ul style="list-style-type: none"> <li>▪ In the <b>NORMAL DISPLAY</b> mode, selecting the <b>SPEED</b> or <b>RCF</b> display mode is obtained by pressing and holding <b>BACK</b> for 1 sec.</li> <li>▪ then use the <b>▲ ▼</b> buttons to select the desired mode (<b>SPEED</b> or <b>RCF</b>) and press <b>SET</b>.</li> </ul>	<ul style="list-style-type: none"> <li>▪ In the <b>SIMPLIFIED DISPLAY</b> mode, the selection of the <b>SPEED</b> or <b>RCF</b> display mode is obtained by pressing and holding the <b>BACK</b> key for 1 second.</li> <li>▪ then use <b>▲ ▼</b> keys to select <b>DISPLAY MODE</b>, press <b>SET</b>, and then use <b>▲ ▼</b> keys to select the desired mode (<b>SPEED</b> or <b>RCF</b>) and press <b>SET</b>.</li> </ul>

#### 10.3.1 Switching the normal display to simplified display

	Press the <b>BACK</b> button for 1 sec. then:
	<ul style="list-style-type: none"> <li>▪ Via <b>▲ ▼</b> keys select <b>SIMPLIFIED DISPLAY</b>. Press <b>SET</b>.</li> </ul>

#### 10.3.2 Switching the simplified screen to normal display

	<ul style="list-style-type: none"> <li>▪ Press the <b>BACK</b> button for 1 sec. then:</li> </ul>
	<ul style="list-style-type: none"> <li>▪ Via <b>▲ ▼</b> keys select <b>DISPLAY MODE</b> (blinking).</li> <li>▪ Press <b>SET</b>.</li> <li>▪ Then choose <b>NORMAL DISPLAY</b> and press <b>SET</b>.</li> </ul>

## 10.4 Rotating runtime

Way of time counting	MENU/CONFIGURATION/ <b>ROTATING RUNTIME</b>
<pre> ROTATING RUNTIME          &lt;=&gt; 2/6 ----- [ ] COUNTING FROM PRESSING START [ ] COUNTING FROM REACHING SPEED [ ] DESCENDING [ ] ASCENDING           </pre>	<ul style="list-style-type: none"> <li>Via ▲▼ choose demanded option.</li> <li>Mark it by pressing <b>SET</b>.</li> </ul>
<b>Counting from:</b>  Pressing start → COUNTING SINCE ROTOR IS IDENTIFIED Reaching speed → COUNTING FROM ASSIGNED SPEED	
<b>Presenting mode:</b>  Descending → COUNTING DOWN Ascending → COUNTING UP	

## 10.5 Buzzer

Switching ON/OFF short audible signals accompanying every pressing of any key. Switching ON/OFF signals after centrifuging.	MENU/ CONFIGURATION / <b>BUZZER</b>
<pre> BUZZER                    &lt;=&gt; 3/6 ----- [ ] KEY TONE [ ] CONTINUOUS ALARM           </pre>	<ul style="list-style-type: none"> <li>With ▲▼ keys select demanded option.</li> <li>Mark selection by pressing <b>SET</b>.</li> </ul> <p>A continuous alarm means the emission of short beeps after the end of the spin, until the message about the end of the work cycle is deleted.</p>
<b>Warning signals are always switched on.</b>	

## 10.6 Date/time

Setiing up time and date	MENU/ CONFIGURATION / <b>DATE/TIME</b>
<pre> DATE/TIME                 &lt;=&gt; 4/6 -----           DATE          TIME           -----          -----           DD-MM-YYYY    HH:MM:SS           05-01-2017    18:48:11           </pre>	<ul style="list-style-type: none"> <li>Press <b>SET</b>.</li> <li>Via ◀▶ keys choose demanded value.</li> </ul> <p>Via ▲▼ keys change choosen value.            Confirm by pressing <b>SET</b>.            Repeat above steps for other values.            Press <b>BACK</b>.</p>
Set date and time are still active even after restart of centrifuge.	

## 10.7 Language

Changing menu language	MENU / CONFIGURATION / <b>LANGUAGE</b>
<pre> LANGUAGE                   &lt;=&gt; 5/6 ----- [ ] POLSKI                 [ ] DEUTSCH [ ] ENGLISH                [ ] РУССКИЙ [ ] ESPAÑOL                [ ] SUENSKA [ ] ITALIANO               [ ] FRANCAIS [ ] PORTUGUES              [ ] ĆESKY           </pre>	<ul style="list-style-type: none"> <li>Via ▲▼ keys choose demanded menu language</li> <li>Mark it by pressing <b>SET</b>.</li> </ul>

## 10.8 Other

Rotor automatic identification	MENU / CONFIGURATION / OTHER
<p>OTHER <span style="float: right;">↔ 6/6</span></p> <hr/> <p> <input checked="" type="checkbox"/> AUTOMATIC IDENTIF.  <input type="checkbox"/> TEMPERATURE: °C  <input checked="" type="checkbox"/> TEMPERATURE: °F  <input type="checkbox"/> SERVICE INSPECTION         </p> <hr/> <p>           SPEED 2000      0      RCF 537      0         </p> <p>           TIME 00:02:00      0      ROTOR IDENTIFICATION !      P °C +20         </p> <p>           PROG: --   11740/-----   PARAM+   MENU+         </p>	<p>Thanks to the automatic rotor identification, the centrifuge automatically identifies the rotor in the chamber. Rotor identification is indicated by the message.</p> <p>When the function is deactivated, it is necessary to manually select the desired rotor as described in <b>Rotor choosing</b>.</p> <p>The <b>AUTOMATIC IDENTIF.</b> is turned on by default.</p> <p>To enable the function:</p> <ul style="list-style-type: none"> <li>▪ Via ▲▼ keys choose</li> <li>▪ <input type="checkbox"/> AUTOMATIC IDENTIF.</li> <li>▪ Press <b>SET</b> (<input type="checkbox"/> change to <input checked="" type="checkbox"/> or conversely).</li> </ul> <p>Autoidentification is not active for work in the loaded program mode.</p>

Choice of temperature unit	MENU / CONFIGURATION / OTHER
<p>OTHER <span style="float: right;">↔ 6/6</span></p> <hr/> <p> <input checked="" type="checkbox"/> AUTOMATIC IDENTIF.  <input type="checkbox"/> TEMPERATURE: °C  <input checked="" type="checkbox"/> TEMPERATURE: °F  <input type="checkbox"/> SERVICE INSPECTION         </p>	<p>The TEMPERATURE in °C is turned on by default.</p> <p>To change the temperature unit:</p> <ul style="list-style-type: none"> <li>▪ Via ▲▼ keys select unit</li> <li>▪ Confirm by pressing <b>SET</b>.</li> </ul>

TEMPERATURE IN °C	TEMPERATURE IN °F
<p>SPEED 2000      0      RCF 537      0</p> <p>TIME 00:02:00      00:02:00      TEMP 12°C +21</p> <p>PROG: --   11740/-----   PARAM+   MENU+</p>	<p>SPEED 2000      0      RCF 537      0</p> <p>TIME 00:02:00      00:02:00      TEMP 53°F 69</p> <p>PROG: --   11740/-----   PARAM+   MENU+</p>

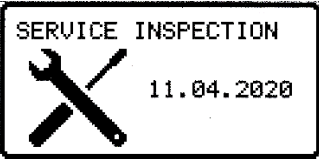
Service reminder	MENU / CONFIGURATION / OTHER
<p>OTHER <span style="float: right;">↔ 6/6</span></p> <hr/> <p> <input checked="" type="checkbox"/> AUTOMATIC IDENTIF.  <input type="checkbox"/> TEMPERATURE: °C  <input checked="" type="checkbox"/> TEMPERATURE: °F  <input checked="" type="checkbox"/> SERVICE INSPECTION            11.04.2020         </p> <hr/> <p>              SERVICE INSPECTION            11.04.2020         </p>	<p>It is possible to turn on a message reminding you to perform the inspection, with the option to define the date of the inspection when the message will be displayed.</p> <p>To enable the function:</p> <ul style="list-style-type: none"> <li>▪ Use the ▲▼ keys to select the field</li> <li>▪ <input type="checkbox"/> SERVICE INSPECTION.</li> <li>▪ Press the SET key (<input type="checkbox"/> it will change to <input checked="" type="checkbox"/>). the function is turned off in the same way</li> </ul>

	<p>A new field will appear with the date of the review (a message will be displayed on that day).</p> <p>To edit the date:</p> <ul style="list-style-type: none"> <li>▪ Move the ▲ ▼ keys to the date field.</li> <li>▪ Press <b>SET</b>.</li> <li>▪ Select the value with ▲ ▼ ◀▶ keys.</li> <li>▪ Confirm with the <b>SET</b> key.</li> </ul>
--	--

## 10.9 Password

<b>Setting up password</b>	<b>MENU / PASSWORD</b>
<p>To prevent from an unauthorized use, a <b>PASSWORD</b> can be set.</p> <p><b>Note:</b> No <b>PASSWORD</b> is set by default.</p> <p>The <b>PASSWORD</b> can be set as follows when the rotor is at a standstill.</p>	
<pre> PASSWORD      LOCK: ----- PASSWORD:    □ SAVE PROGRAM               □ DELETE PROGRAM               □ CHANGE PARAMETERS               □ LOAD PROGRAM               □ START KEY 1234 </pre>	<ul style="list-style-type: none"> <li>▪ With ▲ ▼ keys select the <b>PASSWORD</b> field (is blinking), press SET.</li> <li>▪ With the ▲ ▼ keys select the appropriate digit in the first field, e.g., <b>1xxx</b>.</li> <li>▪ Press ▶</li> <li>▪ With the ▲ ▼ keys select the appropriate digit in the second field, e.g., <b>12xx</b>.</li> <li>▪ Press ▶</li> <li>▪ Use the ▲ ▼ keys to select the appropriate digit in the third field, e.g., <b>123x</b>.</li> <li>▪ Press ▶</li> <li>▪ Use the ▲ ▼ keys to select the correct digit in the fourth field, e.g., <b>1234</b>.</li> <li>▪ Press SET.</li> </ul>
<pre> PASSWORD      LOCK: ----- CONFIRM:     □ SAVE PROGRAM               □ DELETE PROGRAM               □ CHANGE PARAMETERS               □ LOAD PROGRAM               □ START KEY 1234 </pre>	<ul style="list-style-type: none"> <li>▪ As a confirmation repeat instructions described above.</li> </ul>
<p>When the <b>PASSWORD</b> is set, the Key sign is displayed in the <b>CODE</b> zone. It is also displayed in the main menu (lower right corner of the screen).</p>	
<pre> PASSWORD      LOCK: -----               □ SAVE PROGRAM               □ DELETE PROGRAM               □ CHANGE PARAMETERS               □ LOAD PROGRAM               □ START KEY **** </pre>	<p>The screenshot shows the following information:</p> <ul style="list-style-type: none"> <li>SPEED: 2000</li> <li>RCF: 300</li> <li>TIME: 00:02:00</li> <li>TEMP: 20°C +20</li> <li>PROG: --   11199/-----   PARAM+   MENU+  </li> <li>A key icon is visible in the bottom right corner.</li> </ul>
<p>From then on, access to the <b>MENU</b> is possible after entering the password.</p> <p>In case of incorrect password, it will show message: <b>ACCESS DENIED!</b></p>	
<p>The removal of an active password is possible after setting the password "<b>0000</b>" (after entering the currently set password). If the password is forgotten, it is possible to use the emergency password "<b>7654</b>", which removes the previous password and all locks. Using both methods will delete the previous password and disable all security features.</p>	

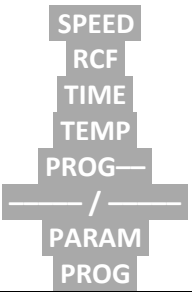

Setting up locks					
<table border="1"> <tr> <td>PASSWORD</td> <td>LOCK:</td> </tr> <tr> <td>****</td> <td> <input type="checkbox"/> SAVE PROGRAM  <input type="checkbox"/> DELETE PROGRAM  <input type="checkbox"/> CHANGE PARAMETERS  <input type="checkbox"/> LOAD PROGRAM  <input type="checkbox"/> START KEY </td> </tr> </table>	PASSWORD	LOCK:	****	<input type="checkbox"/> SAVE PROGRAM <input type="checkbox"/> DELETE PROGRAM <input type="checkbox"/> CHANGE PARAMETERS <input type="checkbox"/> LOAD PROGRAM <input type="checkbox"/> START KEY	<ul style="list-style-type: none"> <li>With ▲▼ keys choose a lock.</li> <li>Mark a lock by pressing <b>SET</b>.</li> <li>Repeat above steps for desired locks.</li> <li>Leave menu with <b>BACK</b> key.</li> </ul>
PASSWORD	LOCK:				
****	<input type="checkbox"/> SAVE PROGRAM <input type="checkbox"/> DELETE PROGRAM <input type="checkbox"/> CHANGE PARAMETERS <input type="checkbox"/> LOAD PROGRAM <input type="checkbox"/> START KEY				

	Disabled*	description
<b>SAVE PROGRAM</b>	<b>SAVE</b> button	<ul style="list-style-type: none"> <li>no programs can be saved</li> </ul>
<b>DELETE PROGRAM</b>	<b>DELETE</b> button	<ul style="list-style-type: none"> <li>no programs can be deleted</li> <li>saving programs on position where one was already stored is disabled</li> </ul>
<b>CHANGE PARAMETERS</b>	fields: 	<ul style="list-style-type: none"> <li>parameters can not be modified</li> </ul>
<b>LOAD PROGRAM</b>	<b>LOAD</b> button	<ul style="list-style-type: none"> <li>no programs can be called up</li> </ul>
<b>START KEY</b>	<b>START</b> key	<ul style="list-style-type: none"> <li>centrifugation can not be started</li> </ul>

\* Executing disabled procedures is only possible after entering the correct

### 10.10 Last 10 cycles

Information concerning parameters of last 10 centrifuging cycles.	MENU / <b>LAST 10 CYCLES</b>
<pre> NO CYCLES: 05 DATE/TIME: 2017.01.05/ 18:18 PROGRAM: -- ROTOR/BUCKET: 11740/----- SPEED: 2000 RCF: 537 TIME: 00:02:00 </pre>	<ul style="list-style-type: none"> <li>Number of cycle can be changed by ◀▶ keys.</li> <li>The list can be scrolled using ▲▼ keys.</li> <li>To exit press <b>SET/BACK</b> key</li> </ul>

### 10.11 Work time

Total working time of centrifuge, and quantity of working cycles.	MENU / <b>WORK TIME</b>
<pre> WORK TIME TOTAL RUN TIME: 0h 13m 14s CYCLES: 31 </pre>	<ul style="list-style-type: none"> <li>In the <b>WORK TIME</b> menu the following statistics are displayed: <ul style="list-style-type: none"> <li>total working (centrifugation) time</li> <li>working cycles counter</li> </ul> </li> </ul>

### 10.12 Rotor runtime

Information about the time of centrifuging and of the quantity of the working cycles of each rotor. The table also contains icons warning of the duty of execution of validation.	MENU / <b>ROTOR RUNTIME</b>
---	-----------------------------



## 11. Maintenance

### 11.1 Cleaning of the centrifuge

	<ul style="list-style-type: none"><li>▪ Pull the mains plug before cleaning.</li><li>▪ Before any cleaning or decontamination process other than that is recommended by the manufacturer, the user has to ask the manufacturer if the planned process does not damage the device</li><li>▪ For cleaning, water with soap or other water-soluble <b>mild detergent</b> shall be used.</li><li>▪ One should avoid corrosive and aggressive substances. It is prohibited to use alkaline solutions, inflammable solvents or agents containing abrasive particles.</li><li>▪ Do not lubricate the centrifuge motor shaft.</li><li>▪ The unused centrifuge should have cover opened.</li></ul> <p style="text-align: center;"><b>Once a week</b></p> <p>Using wiping cloth, remove condensate or residues of the products from the rotor chamber.</p> <p style="text-align: center;"><b>Once a month</b></p> <ul style="list-style-type: none"><li>▪ Check the rotor clamping thread. In case of damage, replaced it.</li><li>▪ Check the centrifuging chamber whether it is damaged. In case of damage, it cannot be longer put into operation. Notify authorized service workshop.</li></ul>
---	---

### 11.2 Maintenance of centrifuge elements

	<ul style="list-style-type: none"><li>▪ The rotor pins shall be always lubricated with petroleum jelly.</li><li>▪ In this way, the uniform deflection of the buckets and quiet centrifuge operation is ensured.</li></ul>
---	---

#### Cleaning of the accessories

	<ul style="list-style-type: none"><li>▪ In order to ensure safe operation, one shall carry out in <b>regular</b> way periodical maintenance of the accessories.</li><li>▪ Rotors, buckets, and round carriers have to withstand high stresses originating from the centrifugal force. Chemical reactions as well as corrosion (combination of variable pressure and chemical reactions) can cause destruction of metals. Hard to observe surface cracks increase gradually and weaken material without visible symptoms.</li></ul> <p>In case of observation of surface damage, crevice, or other change, as well as the corrosion, the given part (rotor, bucket, etc.) shall be immediately replaced.</p> <ul style="list-style-type: none"><li>▪ Clamping rotor, containers and reducer inserts must be cleaned regularly to prevent corrosion.</li><li>▪ Cleaning of the accessories shall be carried out outside of the centrifuge <b>once every week</b> or still better after each use. For cleaning them one should use neutral agent of pH value 6÷8. It is forbidden to use alkaline agent of <b>pH &gt; 8</b>. Then, those parts shall be dried using soft fabric or in the chamber drier at ca. 50°C.</li><li>▪ Angle rotor should be placed on a fabric with holes facing down, for effective drying.</li><li>▪ Do not use bleach on plastic parts of the rotor.</li><li>▪ In this way, the useful service life of the device is substantially increased and susceptibility to corrosion is diminished. Accurate maintenance increases the service life as well and protects against premature rotor failures.</li><li>▪ Do not use bleach on plastic parts of the rotor.</li><li>▪ According to laboratory standards, minimize the immersion time in each solution.</li></ul>
---	---

	<ul style="list-style-type: none"> <li>▪ Especially prone to the corrosion are parts made of aluminium.</li> <li>▪ Corrosion and damages resulting from insufficient maintenance could not be subject of claims lodged against the manufacturer.</li> <li>▪ The unused rotor should have the lid removed.</li> </ul>
--	--

▪ **HS accessories maintenance.**

	<ul style="list-style-type: none"> <li>▪ Check the general condition of seals.</li> <li>▪ Make sure that rubber O-rings are lightly coated with silicone grease. Use high vacuum grease, e.g., type „C” by LUBRINA.</li> <li>▪ In order to maintain hermetic sealing, it is recommended to replace the sealing rings after each autoclaving.</li> <li>▪ Store hermetically sealed rotors and buckets with the lids removed.</li> </ul>
---	--

### 11.3 Sterilization

#### Plastics - legend to abbreviations

<b>PS</b>	polystyrene	<b>ECTFE</b>	ethylene/chlorotrifluoroethylene
<b>SAN</b>	styrene-acrylonitrile	<b>ETFE</b>	ethylene/tetrafluoroethylene
<b>PMMA</b>	polymethyl methacrylate	<b>PTFE</b>	polytetrafluoroethylene
<b>PC</b>	polycarbonate	<b>FEP</b>	tetrafluoroethylene/perfluoropropylene
<b>PVC</b>	polyvinyl chloride	<b>PFA</b>	tetrafluoroethylene/perfluoroalkylvinylether
<b>POM</b>	acetal polyoxymethylenel	<b>FKM</b>	fluorcarbon rubber
<b>PE-LD</b>	low density polyethylene	<b>EPDM</b>	ethylene propylene diene
<b>PE-HD</b>	high density polyethylene	<b>NR</b>	natural rubber
<b>PP</b>	polypropylene	<b>SI</b>	silicon rubber
<b>PMP</b>	polymethylpentene		

One can use all standard disinfectants. Centrifuges and devices are made of different materials, one should consider their variety.

	radiation $\beta$ radiation $\gamma$ 25 kGy	C <sub>2</sub> H <sub>4</sub> O (ethylene oxide)	formalin, ethanol
<b>PS</b>	●	○	●
<b>SAN</b>	○	●	●
<b>PMMA</b>	●	○	●
<b>PC</b>	●	●	●
<b>PVC</b>	○	●	●
<b>POM</b>	●	●	●
<b>PE-LD</b>	●	●	●
<b>PE-HD</b>	●	●	●
<b>PP</b>	●	●	●
<b>PMP</b>	●	●	●
<b>ECTFE, ETFE</b>	○	●	●
<b>PTFE</b>	○	●	●
<b>FEP, PFA</b>	○	●	●
<b>FKM</b>	○	●	●
<b>EPDM</b>	○	●	●
<b>NR</b>	○	●	●
<b>SI</b>	○	●	●

- may be used
- cannot be used

In the centrifuge, disinfectants and cleaning agents generally used in medical care should be used (e.g., Aerodesina-2000, Lysoformin 3000, Melseptol, Melsept SF, Sanepidex, Cutasept F).

### 11.3.1 Autoclaving

- Rotors, buckets and round carriers can be sterilized in autoclave with temperature 121°C during 20 min (215 kPa), unless otherwise specified in the OPTIONAL ACCESSORY.
- During sterilization (autoclaved) by means of steam one should consider temperature resistance of individual materials.
- Deformation of the accessories (carriers or lids made of plastic) may occur during autoclaving.
- Do not autoclave disposable materials (e.g., tubes, cyto-container).
- The life of the accessory depends on the frequency of autoclaving and use.
- Autoclaving reduces lifespan of plastic components. They should be replaced if any signs of damage are visible, including a change in colour or shape or when leakage etc.
- Pressure in closed containers can cause plastic deformation or explosion.
- Prior to autoclaving the rotors and accessories, thoroughly wash and rinse with distilled water.
- Never exceed the permissible autoclaving temperature and time.
- If you want to keep the hermetic seals, replace the sealing rings after each autoclave.

#### Chemical resistance of plastics

	autoclaving 121 °C, 20 min		autoclaving 121 °C, 20 min
PS	○	PMP	●
SAN	○	ECTFE, ETFE	●
PMMA	○	PTFE	●
PC	●	FEP, PFA	●
PVC	○ <sup>1)</sup>	FKM	●
POM	●	EPDM	●
PE-LD	○	NR	○
PE-HD	○	SI	●
PP	●		

● may be used

○ cannot be used

1) Except PVC hoses which are resistant to the steam sterilization in the temperature 121°C.

### 11.4 Chemical resistance

#### Chemical resistance of plastics



	aldehydes	cyclic alcohols	esters	ether	ketones	strong or concentrated acids	weak or diluted acids	oxidizing substances	cyclic hydrocarbons	ahs	haloid hydrocarbons	alkalis
PS	○	●	○	○	○	○/●	○/●	○	○	○	○	●
SAN	○	●	○	○	○	○	○/●	○	○	○	○	●
PMMA	○/●	●	○	○	○	○	○/●	○	○/●	○	○	○
PC	○/●	●	○	○	○	○	○/●	○	○/●	○	○	○
PVC	○	●	○	○	○	●	●	○	●	○	○	●
POM	○/●	●	○	●	●	○	○	○	●	●	●	●
PE-LD		●	●	●	○/●	●	●	○	●	●	●	●

PE-HD	•	•	o/•	o/•	o/•	•	•	o	•	o/•	o/•	•
PP	•	•	o/•	o/•	o/•	•	•	o	•	o/•	o/•	•
PMP	o/•	•	o/•		o/•	•	•	o	o/•	o	o	•
ECTFE ETFE	•	•	•	•	o	•	•	•	•	•	•	•
PTFE FEP PFA	•	•	•	•	•	•	•	•	•	•	•	•
FKM	•	o	o	o	o	o	•	o/•	o/•	o/•	o/•	o/•
EPDM	•	•	o/•	o	o/•	•	•	o/•	o	o	o	•
NR	o/•	•	o/•	o	o	o	o/•	o	o	o	o	•
SI	o/•	•	o/•	o	o	o	o/•	o	o	o	o	o/•

•	very good	Permanent action of the substance does not cause damage through 30 days. The material is able to be resistant through years
o/•	good to limited	Continuous action of the substance causes insignificant and partly reversible damage through the period of 7-30 days (e.g. puffing up, softening, reduced mechanical durability, discolouring).
o	limited	The material should not have the continuous contact with the substance. The immediate occurrence of damage is possible (e.g. the loss of mechanical durability, deformation, discolouring, bursting, dissolving).





Rubber inserts shall be exactly cleaned or possibly replaced. Centrifuges and accessories are made of different materials.

Do not use bleach on plastic parts of the rotor.

	<b>DANGER!</b> MPW accessories are not biotight. For centrifuging infectious materials, it is necessary to use hermetically closed tubes meeting demands of biotightness, in order to prevent germs migration into the centrifuge and beyond it.
	User is responsible for proper disinfections of the centrifuge if some dangerous material was spilled inside or outside of the centrifuge. During the above mentioned works one must wear safety gloves.

## 12. Troubleshooting

Majority of faults could be removed by switching the centrifuge OFF and then ON. After switching the centrifuge ON, there shall be displayed parameters of the recently implemented program and sound signals comprising four successive tones shall be generated. In case of short-duration power failure the centrifuge terminates the cycle and displays PROGRAM ERROR code.

problem	question	remedy
<b>Centrifuge does not start</b>	<i>Is supply cable plugged into mains?</i>	<i>Plugs supply cable correctly.</i>
	<i>Is master switch ON?</i>	<i>Switch ON power supply.</i>
<b>Motor error is displayed</b>		Call service.
<b>Centrifuge does not start</b> <small>(indications are proof for cycle in progress and motor does not start)</small>	<i>Is  symbol displayed?</i>	Wait till rotor stops and the  symbol goes off.
	<i>Is  symbol displayed?</i>	Close cover.  symbol must switch off.
	<i>Is  symbol blinking?</i>	Centrifugation cycle in progress, press STOP key or wait till cycle ends.
<b>Centrifuge does not accelerate</b> <small>(unbalance error)</small>	<i>Unequal rotor load.</i>	Centrifuge load shall be balanced.
	<i>Inclined centrifuge.</i>	Centrifuge shall be levelled.
	<i>Faulty drive (mechanical damage).</i>	Call service.

	<i>Was centrifuge displaced during operation?</i>	Switch ON the centrifuge again after opening and closing the cover.
<i>(motor error)</i>	<i>After stopping error rotor message is displayed</i>	Check if rotor number in started program is consistent with the number of the rotor installed in the centrifuge. Check rotor status (if there are coding magnets inserted)
	<i>Centrifuge does not recognize the rotor and does not stop.</i>	Switch the centrifuge OFF, then ON and check correctness of loaded program
<b>It is not possible to open the cover</b>	<i>■ symbol on the display is blinking, after pressing COVER key single tone is audible</i>	Rotor is still rotating. Wait for stopping of the rotor and displaying of the ■ symbol.
	<i>The sensor is connected correctly, and the error is still applying.</i>	Call service.
<b>Mains failure during run</b>	<i>The message will be displayed on the display about the decay of tension.</i>	Wait for stopping of the rotor, clear the error by pressing the SET key.
<b>Temperature sensor error</b>	<i>The overheating message will be displayed.</i>	Switch the centrifuge OFF, then ON.
		Call service.
<b>Error of the exceeding the temperature (50°C) in the chamber</b>	<i>The overheating message will be displayed.</i>	Call service.

## 12.1 Messages

<b>Screen messages that may occur during operation.</b>	
<b>MESSAGE</b>	<b>EXPLANATION</b>
"SPEED OF ROTOR" "IDENTIFICATION <> 90 RPM"	Please try start centrifuging again, if error still occur, contact manufacturer's authorized service.
"IMBALANCE FAST STOP !" "PLEASE REMOVE CAUSE" "THEN RESTART"	Rotor is not balanced correctly, please balance rotor.
"NO ROTOR OR IDENTIFICATION" "SENSOR DAMAGED !"	Make sure, is rotor mounted in the centrifuge chamber. If it is right contact manufacturer's authorized service.
"INCORRECT ROTOR NUMBER !"	Change rotor number in centrifuge settings or use autoidentification.
"WRONG DIRECTION OF ROTATION" "OR UNKNOWN ROTOR !"	Make sure if correct rotor for centrifuge is mounted. List of accessories is described in chapter 15.
"PLEASE CLOSE THE LID" "HAND !"	Necessity of manually closing the lid.
"ROTOR STOPPING !" "Please wait..."	Initializing after mains failure with rotating rotor, wait until rotor stop.

<b>Emergency messages</b>	
In case of emergency messages (centrifuge is not working properly) contact the manufacturer's authorized service centre.	
<b>MESSAGE</b>	
	"OVERHEATING MOTOR !" "INVERTER ERROR !"
	"INVERTER SERIAL BUS ERROR !"
	"TEMPERATURE SENSOR ERROR"
	"PRESSURE CONTROL FAILURE!"
	"OPENING COVER in RUN!"
	"SPEED METER ERROR"
	"I2C BUS ERROR"
	"OVERHEATING CENTRIFUGE !"
	"ROTOR OVERSPEED !"
	"COVER LOCK MALFUNCTION !"

## 12.2 Emergency cover release

	<p><b>EMERGENCY COVER RELEASE</b></p> <p><b>Attention!</b> <i>The cover may be opened in emergency only when the rotor is at rest. Before emergency opening the cover, switch off the mains power switch and disconnect the power cord. Wait 10 min and/or looking through the sight glass, make sure that the rotor is not rotating.</i></p> <p>To do this, insert the key into the emergency opening of the cover (Cat. No. 17799) into the hole (you must first remove the plug) on the front of the centrifuge and then turn it anticlockwise until you release the lock and open the cover.</p>
--	--

## 13. Guarantee

Manufacturer grants to the Buyer the guarantee on conditions specified in the Guarantee Certificate. Buyer forfeits the right to guarantee repair when using the device inconsistently with the User manual provisions, when damage results from the User's fault.

Repairs should be carried out in authorized service workshops, granted with the MPW Certificate.

The centrifuge shall be sent to repair after decontaminating disinfections. Information about authorized service workshops could be obtained from the Manufacturer.

	<ul style="list-style-type: none"> <li>▪ Guarantee period amounts to 24 months (unless otherwise specified in the purchase documents).</li> <li>▪ Guarantee conditions are described in guaranteed card.</li> <li>▪ The service life of the centrifuge specified by the manufacturer amounts to 10 years.</li> <li>▪ After 24 months from the start of the warranty period (date of purchase), a technical inspection of the centrifuge should be carried out (validation) by an authorized service of the manufacturer. Subsequent inspections should be carried out at annual intervals.</li> <li>▪ Maximum period of storage of not used centrifuge amounts to 1 year. After this period, a service authorized by manufacturer should carry out technical inspection of the centrifuge.</li> <li>▪ Manufacturer reserves the right to make technical changes in manufactured products.</li> </ul>
---	--



## 14. Transport and storage



**CAUTION!** Due to the heavy weight of the device, lifting and carrying it may cause injury to the spine.

- Store the device only in a closed and dry room.
- Remove rotor from centrifuge before transport.
- Lift and carry with the adequate number of people.
- Use transport equipment.
- Use the original packaging and transport protection for transport.

### Transport and storage conditions.

	Storage (in the package)	Storage (without the package)	Transport
Temperature	-25 ÷ +55 °C	-5 ÷ +45 °C	-25 ÷ +60 °C (general) -20 ÷ +55 °C (air)
Relative humidity	10 ÷ 75 %	10 ÷ 75 %	10 ÷ 75 %
Pressure	70 ÷ 106 kPa	70 ÷ 106 kPa	30 ÷ 106 kPa

## 15. Disposal



- When you are disposing the device, the respective statutory rules must be observed.
- Pursuant to guideline 2002/96/EC (WEEE), all devices supplied after August 13, 2005, may not be disposed as part of domestic waste.
- The device belongs to 8th group (medical devices) and is categorized in business-to-business field.
- The icon of the crossed-out trash can show that the device may not be disposed as part of domestic waste. The waste disposal guidelines of the individual EC countries might vary. If necessary, contact your supplier.

## 16. Manufacturer's info

"MPW MED. INSTRUMENTS" SPÓŁDZIELNIA PRACY

Boremlowska 46 Street

04-347 Warsaw

tel. (+48) 22 610 56 67 (sales department - POLAND)  
(+48) 22 879 70 46 (sales department - outside POLAND)  
(+48) 22 610 81 07 (service)

fax: (+48) 22 610 55 36

e-mail: mpw@mpw.pl

website: www.mpw.pl

000042924 - number of entry in the Waste Database

PL/CA01-01782 - identification number given by Office for Registration of Medicinal Products,  
Medical Devices and Biocidal Products.

## Distributor's info

**DISTRIBUTOR:**

## 17. ANNEXES

**A. Wyposażenie dodatkowe/Optional accessories****MPW-380/R****WIRNIK / ROTOR****PARAMETRY WIRNIKA / ROTOR PARAMETERS****POJEMNIK/BUCKET****WKŁADKA / ADAPTER**[liczba probówek na wirnik/tubes per rotor] **PROBÓWKA / TUBE****11762****RPM 18000, RCF 30065, Rmax 83,  $\phi$  45 (352R/RH)****bez pojemnika/without bucket****14084**[36] 15127 0,5 ml probówka PCR (7,8 x 31 mm)  
0,5 ml PCR tube (7,8 x 31 mm)**14126**[36] 15124 0,4 ml probówka PCR (5,7 x 48,6 mm)  
0,4 ml PCR tube (5,7 x 48,6 mm)**14133**[36] 15125 0,2 ml probówka PCR (6 x 21,6 mm)  
0,2 ml PCR tube (6 x 21,6 mm)**bez wkładki/without adapter**[36] \* 2-1,5 ml probówka (10,8x41,8 mm), Eppendorf®; [15011], 2 ml (10,8x41,8 mm); [15128], 1,5ml (10,8x40,5 mm)  
2-1,5 ml tube (10,8x41,8 mm), Eppendorf®; [15011], 2 ml (10,8x41,8 mm); [15128], 1,5ml (10,8x40,5 mm)[36] \* 2 ml probówki z filtrem - spin columns (10,8 x 46 mm)  
2 ml spin columns (with filter) (10,8 x 46 mm); [15011], 2 ml (10,8x41,8 mm); [15128], 1,5ml (10,8x40,5 mm)**11763****RPM 16400, RCF 28266, Rmax 94,  $\phi$  45****bez pojemnika/without bucket****14084**[48] 15127 0,5 ml probówka PCR (7,8 x 31 mm)  
0,5 ml PCR tube (7,8 x 31 mm)**14126**[48] 15124 0,4 ml probówka PCR (5,7 x 48,6 mm)  
0,4 ml PCR tube (5,7 x 48,6 mm)**14133**[48] 15125 0,2 ml probówka PCR (6 x 21,6 mm)  
0,2 ml PCR tube (6 x 21,6 mm)**bez wkładki/without adapter**[48] \* 2-1,5 ml probówka (10,8x41,8 mm), Eppendorf®; [15011], 2 ml (10,8x41,8 mm); [15128], 1,5ml (10,8x40,5 mm)  
2-1,5 ml tube (10,8x41,8 mm), Eppendorf®; [15011], 2 ml (10,8x41,8 mm); [15128], 1,5ml (10,8x40,5 mm)[48] \* 2 ml probówki z filtrem - spin columns (10,8 x 46 mm)  
2 ml spin columns (with filter) (10,8 x 46 mm); [15011], 2 ml (10,8x41,8 mm); [15128], 1,5ml (10,8x40,5 mm)**11765****RPM 16400, RCF 28566, Rmax 95,  $\phi$  45****bez pojemnika/without bucket****bez wkładki/without adapter**[12] 15122 8 x 0,2 ml probówki szeregowo PCR-strip (10,2 x 72,4 mm)  
8 x 0,2 ml PCR strip (10,2 x 72,4 mm)[96] 15125 0,2 ml probówka PCR (6 x 21,6 mm)  
0,2 ml PCR tube (6 x 21,6 mm)

**A. Wyposażenie dodatkowe/Optional accessories****MPW-380/R****11766****RPM 18000, RCF 31876, Rmax 88,  $\phi$  45****bez pojemnika/without bucket****bez wkładki/without adapter**

- |      |       |   |
|------|-------|---|
| [12] | *     | 10 ml Thermo Nalgene® Oak Ridge (16 x 81,5 mm)  |
| [12] | 15121 | 10 ml probówka z dnem okrągłym i pokrywką (17 x 70 mm)<br>10 ml tube, round bottom, with cap (17 x 70 mm) |

**11767****RPM 14000, RCF 20598, Rmax 94,  $\phi$  30****bez pojemnika/without bucket****bez wkładki/without adapter**

- |      |       |  |
|------|-------|--|
| [12] | 15053 | 10 ml probówka z pokrywką (16 x 106 mm)<br>10 ml tube with cap (16 x 106 mm) |
| [12] | 15118 | 10 ml probówka szklana (16 x 100 mm)<br>10 ml glass tube (16 x 100 mm)       |

**11769****RPM 16400, RCF 29168, Rmax 97,  $\phi$  45****bez pojemnika/without bucket****14084**

- |      |       |  |
|------|-------|--|
| [60] | 15127 | 0,5 ml probówka PCR (7,8 x 31 mm)<br>0,5 ml PCR tube (7,8 x 31 mm) |
|------|-------|--|

**14126**

- |      |       |  |
|------|-------|--|
| [60] | 15124 | 0,4 ml probówka PCR (5,7 x 48,6 mm)<br>0,4 ml PCR tube (5,7 x 48,6 mm) |
|------|-------|--|

**14133**

- |      |       |  |
|------|-------|--|
| [60] | 15125 | 0,2 ml probówka PCR (6 x 21,6 mm)<br>0,2 ml PCR tube (6 x 21,6 mm) |
|------|-------|--|

**bez wkładki/without adapter**

- |      |   |  |
|------|---|--|
| [60] | * | 2-1,5 ml probówka (10,8x41,8 mm), Eppendorf®; [15011], 2 ml (10,8x41,8 mm); [15128], 1,5ml (10,8x40,5 mm)<br>2-1,5 ml tube (10,8x41,8 mm), Eppendorf®; [15011], 2 ml (10,8x41,8 mm); [15128], 1,5ml (10,8x40,5 mm) |
| [60] | * | 2 ml probówki z filtrem - spin columns (10,8 x 46 mm)<br>2 ml spin columns (with filter) (10,8 x 46 mm); [15011], 2 ml (10,8x41,8 mm); [15128], 1,5ml (10,8x40,5 mm)   |

**11770****RPM 14000, RCF 23228, Rmax 106,  $\phi$  30****bez pojemnika/without bucket****14047**

- |      |       |   |
|------|-------|---|
| [12] | 15419 | 5 ml probówka z korkiem (12 x 85 mm), Sarstedt®<br>5 ml tube with cap (12 x 85 mm), Sarstedt® |
|------|-------|---|

**14868**

- |      |   |  |
|------|---|--|
| [12] | * | 5 ml probówka z korkiem wciskanym (17 x 54,2 mm), Eppendorf®<br>5 ml tube with snap cap (17 x 54,2 mm), Eppendorf® |
| [12] | * | 5 ml probówka z korkiem zakręcany (17 x 66 mm), Eppendorf®<br>5 ml tube with screw cap (17 x 66 mm), Eppendorf®    |

**bez wkładki/without adapter**

- |      |   |  |
|------|---|--|
| [12] | * | 15 ml probówka z dnem stożkowym z zakrętką (17 x 120 mm), Falcon®; [15050], 15ml (17 x 120 mm)<br>15 ml tube, conical bottom, with cap (17 x 120 mm), Falcon®; [15050] 15ml Sarstedt®(17 x 120 mm) |
|------|---|--|

**11772**

**A. Wyposażenie dodatkowe/Optional accessories****MPW-380/R****RPM 17500, RCF 29788, Rmax 87,  $\phi$  30****bez pojemnika/without bucket****bez wkładki/without adapter**

- |     |       |  |
|-----|-------|--|
| [8] | 15056 | 30 ml Thermo Nalgene® Oak Ridge (25,5 x 94,3 mm)<br>30 ml Thermo Nalgene® Oak Ridge (25,5 x 94,3 mm) |
| [8] | 15424 | 30 ml probówka z pokrywką (25,5 x 94 mm), Nalgene®<br>30 ml tube with cap (25,5 x 94 mm), Nalgene®   |

**11773****RPM 14500, RCF 21625, Rmax 92,  $\phi$  30****bez pojemnika/without bucket****14035**

- |     |       |  |
|-----|-------|--|
| [6] | 15046 | 14 ml probówka z pokrywką (16,8 x 113,7 mm), Sarstedt®<br>14 ml tube with cap (16,8 x 113,7 mm), Sarstedt® |
| [6] | 15053 | 10 ml probówka z pokrywką (16 x 106 mm)<br>10 ml tube with cap (16 x 106 mm)                               |

**14036**

- |     |       |  |
|-----|-------|--|
| [6] | 15054 | 6 ml probówka z pokrywką (11,5 x 92 mm), Sarstedt®<br>6 ml tube with cap (11,5 x 92 mm), Sarstedt® |
|-----|-------|--|

**bez wkładki/without adapter**

- |     |       |  |
|-----|-------|--|
| [6] | 15051 | 50 ml Thermo Nalgene® Oak Ridge (28,8 x 106,7 mm)<br>50 ml Thermo Nalgene® Oak Ridge (28,8 x 106,7 mm) |
|-----|-------|--|

**11775****RPM 14000, RCF 21255, Rmax 97,  $\phi$  30****bez pojemnika/without bucket****14035**

- |     |       |  |
|-----|-------|--|
| [8] | 15046 | 14 ml probówka z pokrywką (16,8 x 113,7 mm), Sarstedt®<br>14 ml tube with cap (16,8 x 113,7 mm), Sarstedt® |
| [8] | 15048 | 15 ml Thermo Nalgene® (16 x 113 mm)<br>15 ml Thermo Nalgene® (16 x 113 mm)                                 |
| [8] | 15053 | 10 ml probówka z pokrywką (16 x 106 mm)<br>10 ml tube with cap (16 x 106 mm)                               |
| [8] | 15118 | 10 ml probówka szklana (16 x 100 mm)<br>10 ml glass tube (16 x 100 mm)                                     |

**14036**

- |     |       |  |
|-----|-------|--|
| [8] | 15054 | 6 ml probówka z pokrywką (11,5 x 92 mm), Sarstedt®<br>6 ml tube with cap (11,5 x 92 mm), Sarstedt® |
| [8] | 15119 | 7 ml probówka szklana (12 x 100 mm)<br>7 ml glass tube (12 x 100 mm)                               |

**bez wkładki/without adapter**

- |     |       |  |
|-----|-------|--|
| [8] | 15051 | 50 ml Thermo Nalgene® Oak Ridge (28,8 x 106,7 mm)<br>50 ml Thermo Nalgene® Oak Ridge (28,8 x 106,7 mm) |
|-----|-------|--|

**11776****RPM 14000, RCF 23666, Rmax 108,  $\phi$  30****bez pojemnika/without bucket****14043**

- |     |       |   |
|-----|-------|---|
| [8] | *     | Greiner Vacuette® (13 x 75 mm), (1-4,5 ml)  |
| [8] | 15120 | 5 ml probówka szklana (12 x 75 mm)<br>5 ml glass tube (12 x 75 mm)                            |
| [8] | 15419 | 5 ml probówka z korkiem (12 x 85 mm), Sarstedt®<br>5 ml tube with cap (12 x 85 mm), Sarstedt® |

**14071**

- |     |   |   |
|-----|---|---|
| [8] | * | 28 ml Thermo Nalgene® Oak Ridge (25,4 x 101,8 mm) |
|-----|---|---|

\* probówka niedostępna w ofercie MPW lub dostępny odpowiednik (np.[15050]), patrz kolumna z prawej  
tube is not offered by MPW or equivalent is available (e.g. [15050]), see column on the right

**A. Wyposażenie dodatkowe/Optional accessories****MPW-380/R**

[8]	15055	30 ml probówka z pokrywką (25,4 x 103,2 mm) 30 ml tube with cap (25,4 x 103,2 mm)
[8]	15056	30 ml Thermo Nalgene® Oak Ridge (25,5 x 94,3 mm) 30 ml Thermo Nalgene® Oak Ridge (25,5 x 94,3 mm)
[8]	15424	30 ml probówka z pokrywką (25,5 x 94 mm), Nalgene® 30 ml tube with cap (25,5 x 94 mm), Nalgene®
<b>14073</b>		
[8]	*	BD Vacutainer® (16 x 100 mm), (2,5-11 ml)
[8]	*	Greiner Vacuette® (16 x 100 mm), (7-9 ml)
[8]	*	Sarstedt S-Monovette® (15 x 92 mm), (7,5; 8,2; 8,5 ml)
[8]	*	Sarstedt S-Monovette® (16 x 92 mm), (9; 10 ml)
[8]	15046	14 ml probówka z pokrywką (16,8 x 113,7 mm), Sarstedt® 14 ml tube with cap (16,8 x 113,7 mm), Sarstedt®
[8]	15053	10 ml probówka z pokrywką (16 x 106 mm) 10 ml tube with cap (16 x 106 mm)
[8]	15118	10 ml probówka szklana (16 x 100 mm) 10 ml glass tube (16 x 100 mm)
<b>14089</b>		
[8]	*	15 ml probówka z dnem stożkowym z zakrętką (17 x 120 mm), Falcon®; [15050], 15ml (17 x 120 mm) 15 ml tube, conical bottom, with cap (17 x 120 mm), Falcon®; [15050] 15ml Sarstedt®(17 x 120 mm)
<b>14089+14868</b>		
[8]	*	5 ml probówka z korkiem wciskany (17 x 54,2 mm), Eppendorf® 5 ml tube with snap cap (17 x 54,2 mm), Eppendorf®
[8]	*	5 ml probówka z korkiem zakręcany (17 x 66 mm), Eppendorf® 5 ml tube with screw cap (17 x 66 mm), Eppendorf®
<b>bez wkładki/without adapter</b>		
[8]	*	50 ml probówka z dnem stożkowym z zakrętką (30 x 117 mm), Falcon®; [15052] 50ml (30 x 117mm) 50 ml tube, conical bottom, with cap (30 x 117 mm), Falcon®; [15052] 50ml Sarstedt® (30 x 117 mm)
[8]	*	50 ml probówka z dnem stożkowym bez rantu (30 x 115 mm), Greiner® 50 ml tube, conical bottom, without skirt (30 x 115 mm), Greiner®

**11777****RPM 10000, RCF 14087, Rmax 126,  $\phi$  25****bez pojemnika/without bucket**

<b>14017</b>		
[4]	15129	250 ml butelka okrągłodenna (62 x 122 mm), Herolab® nr 25 34 43 250 ml round-bottom bottle (62 x 122 mm), Herolab® no. 25 34 43
<b>14152</b>		
[4]	*	50 ml probówka z dnem stożkowym z zakrętką (30 x 117 mm), Falcon®; [15052] 50ml (30 x 117mm) 50 ml tube, conical bottom, with cap (30 x 117 mm), Falcon®; [15052] 50ml Sarstedt® (30 x 117 mm)
[4]	*	50 ml probówka z dnem stożkowym bez rantu (30 x 115 mm), Greiner® 50 ml tube, conical bottom, without skirt (30 x 115 mm), Greiner®
<b>14175</b>		
[4]	15175	250 ml butelka płaskodenna (62 x 122 mm), Herolab® nr 25 34 21 250 ml bottle, flat bottom (62 x 122 mm), Herolab® no. 25 34 21
[4]	15176	250 ml butelka płaskodenna (62 x 122 mm), Herolab® nr 25 34 01 250 ml bottle, flat bottom (62 x 122 mm), Herolab® no. 25 34 01
<b>bez wkładki/without adapter</b>		
[4]	15175	250 ml butelka płaskodenna (62 x 122 mm), Herolab® nr 25 34 21 250 ml bottle, flat bottom (62 x 122 mm), Herolab® no. 25 34 21
[4]	15176	250 ml butelka płaskodenna (62 x 122 mm), Herolab® nr 25 34 01 250 ml bottle, flat bottom (62 x 122 mm), Herolab® no. 25 34 01

**11778****RPM 12000, RCF 17709, Rmax 110,  $\phi$  30****bez pojemnika/without bucket**

<b>14855</b>		
[6]	*	50 ml probówka z dnem stożkowym z zakrętką (30 x 117 mm), Falcon®; [15052] 50ml (30 x 117mm) 50 ml tube, conical bottom, with cap (30 x 117 mm), Falcon®; [15052] 50ml Sarstedt® (30 x 117 mm)
[6]	*	50 ml probówka z dnem stożkowym bez rantu (30 x 115 mm), Greiner® 50 ml tube, conical bottom, without skirt (30 x 115 mm), Greiner®
<b>14856</b>		

**A. Wyposażenie dodatkowe/Optional accessories****MPW-380/R**

[6] \* 15 ml probówka z dnem stożkowym z zakrętką (17 x 120 mm), Falcon®; [15050], 15ml (17 x 120 mm)  
15 ml tube, conical bottom, with cap (17 x 120 mm), Falcon®; [15050] 15ml Sarstedt®(17 x 120 mm)

**bez wkładki/without adapter**

[6] 15067 85 ml Thermo Nalgene® Oak Ridge (38,2 x 105,7 mm)  
85 ml Thermo Nalgene® Oak Ridge (38,2 x 105,7 mm)

**11779**

**RPM 15000, RCF 22136, Rmax 88,  $\phi$  45**

**bez pojemnika/without bucket**

**14084**

[36] 15127 0,5 ml probówka PCR (7,8 x 31 mm)  
0,5 ml PCR tube (7,8 x 31 mm)

**14126**

[36] 15124 0,4 ml probówka PCR (5,7 x 48,6 mm)  
0,4 ml PCR tube (5,7 x 48,6 mm)

**14133**

[36] 15125 0,2 ml probówka PCR (6 x 21,6 mm)  
0,2 ml PCR tube (6 x 21,6 mm)

**bez wkładki/without adapter**

[36] \* 2-1,5 ml probówka (10,8x41,8 mm), Eppendorf®; [15011], 2 ml (10,8x41,8 mm); [15128], 1,5ml (10,8x40,5 mm)  
2-1,5 ml tube (10,8x41,8 mm), Eppendorf®; [15011], 2 ml (10,8x41,8 mm); [15128], 1,5ml (10,8x40,5 mm)

[36] \* 2 ml probówki z filtrem - spin columns (10,8 x 46 mm)  
2 ml spin columns (with filter) (10,8 x 46 mm); [15011], 2 ml (10,8x41,8 mm); [15128], 1,5ml (10,8x40,5 mm)

**11780**

**RPM 4500, RCF 3328, Rmax 147,  $\phi$  30**

**13276**

**14035**

[12] 15046 14 ml probówka z pokrywką (16,8 x 113,7 mm), Sarstedt®  
14 ml tube with cap (16,8 x 113,7 mm), Sarstedt®

[12] 15048 15 ml Thermo Nalgene® (16 x 113 mm)  
15 ml Thermo Nalgene® (16 x 113 mm)

[12] 15053 10 ml probówka z pokrywką (16 x 106 mm)  
10 ml tube with cap (16 x 106 mm)

[12] 15118 10 ml probówka szklana (16 x 100 mm)  
10 ml glass tube (16 x 100 mm)

**14036**

[12] \* BD Vacutainer® (13 x 100 mm), (4-7 ml)

[12] 15054 6 ml probówka z pokrywką (11,5 x 92 mm), Sarstedt®  
6 ml tube with cap (11,5 x 92 mm), Sarstedt®

[12] 15119 7 ml probówka szklana (12 x 100 mm)  
7 ml glass tube (12 x 100 mm)

**14043**

[12] \* Greiner Vacuette® (13 x 75 mm), (1-4,5 ml)

[12] \* Sarstedt S-Monovette® (13 x 75 mm), (2,7; 3; 4,3 ml)

[12] \* Sarstedt S-Monovette® (13 x 90 mm), (4,9; 5,6 ml)

[12] 15419 5 ml probówka z korkiem (12 x 85 mm), Sarstedt®  
5 ml tube with cap (12 x 85 mm), Sarstedt®

[12] 15120 5 ml probówka szklana (12 x 75 mm)  
5 ml glass tube (12 x 75 mm)

**14071**

[12] \* 28 ml Thermo Nalgene® Oak Ridge (25,4 x 101,8 mm)

[12] 15055 30 ml probówka z pokrywką (25,4 x 103,2 mm)  
30 ml tube with cap (25,4 x 103,2 mm)

[12] 15056 30 ml Thermo Nalgene® Oak Ridge (25,5 x 94,3 mm)  
30 ml Thermo Nalgene® Oak Ridge (25,5 x 94,3 mm)

[12] 15424 30 ml probówka z pokrywką (25,5 x 94 mm), Nalgene®  
30 ml tube with cap (25,5 x 94 mm), Nalgene®

**14073**

[12] \* BD Vacutainer® (16 x 100 mm), (2,5-11 ml)

[12] \* Greiner Vacuette® (16 x 100 mm), (7-9 ml)

[12] \* Sarstedt S-Monovette® (15 x 92 mm), (7,5; 8,2; 8,5 ml)

\* probówka niedostępna w ofercie MPW lub dostępny odpowiednik (np.[15050]), patrz kolumna z prawej  
tube is not offered by MPW or equivalent is available (e.g. [15050]), see column on the right

**A. Wyposażenie dodatkowe/Optional accessories****MPW-380/R**

[12]	*	Sarstedt S-Monovette® (16 x 92 mm), (9; 10 ml)
[12]	15046	14 ml probówka z pokrywką (16,8 x 113,7 mm), Sarstedt® 14 ml tube with cap (16,8 x 113,7 mm), Sarstedt®
[12]	15053	10 ml probówka z pokrywką (16 x 106 mm) 10 ml tube with cap (16 x 106 mm)
[12]	15118	10 ml probówka szklana (16 x 100 mm) 10 ml glass tube (16 x 100 mm)
<b>14089</b>		
[12]	*	15 ml probówka z dnem stożkowym z zakrętką (17 x 120 mm), Falcon®; [15050], 15ml (17 x 120 mm) 15 ml tube, conical bottom, with cap (17 x 120 mm), Falcon®; [15050] 15ml Sarstedt®(17 x 120 mm)
<b>14248</b>		
[12]	15055	30 ml probówka z pokrywką (25,4 x 103,2 mm) 30 ml tube with cap (25,4 x 103,2 mm)
<b>14089+14868</b>		
[12]	*	5 ml probówka z korkiem wciskany (17 x 54,2 mm), Eppendorf® 5 ml tube with snap cap (17 x 54,2 mm), Eppendorf®
[12]	*	5 ml probówka z korkiem zakręcany (17 x 66 mm), Eppendorf® 5 ml tube with screw cap (17 x 66 mm), Eppendorf®
<b>bez wkładki/without adapter</b>		
[12]	15051	50 ml Thermo Nalgene® Oak Ridge (28,8 x 106,7 mm) 50 ml Thermo Nalgene® Oak Ridge (28,8 x 106,7 mm)
[12]	*	50 ml probówka z dnem stożkowym z zakrętką (30 x 117 mm), Falcon®; [15052] 50ml (30 x 117mm) 50 ml tube, conical bottom, with cap (30 x 117 mm), Falcon®; [15052] 50ml Sarstedt® (30 x 117 mm)
[12]	*	50 ml probówka z dnem stożkowym bez rantu (30 x 115 mm), Greiner® 50 ml tube, conical bottom, without skirt (30 x 115 mm), Greiner®
[12]	*	50 ml probówka Advanced Oak Ridge (29x102 mm), Herolab® nr 25 32 11 50 ml tube, Advanced Oak Ridge (29 x 102 mm), Herolab® no. 25 32 11
<b>13278+17151</b>		
<b>14035</b>		
[12]	15046	14 ml probówka z pokrywką (16,8 x 113,7 mm), Sarstedt® 14 ml tube with cap (16,8 x 113,7 mm), Sarstedt®
[12]	15048	15 ml Thermo Nalgene® (16 x 113 mm) 15 ml Thermo Nalgene® (16 x 113 mm)
[12]	15053	10 ml probówka z pokrywką (16 x 106 mm) 10 ml tube with cap (16 x 106 mm)
[12]	15118	10 ml probówka szklana (16 x 100 mm) 10 ml glass tube (16 x 100 mm)
<b>14036</b>		
[12]	15054	6 ml probówka z pokrywką (11,5 x 92 mm), Sarstedt® 6 ml tube with cap (11,5 x 92 mm), Sarstedt®
[12]	15119	7 ml probówka szklana (12 x 100 mm) 7 ml glass tube (12 x 100 mm)
<b>14043</b>		
[12]	*	Greiner Vacuette® (13 x 75 mm), (1-4,5 ml)
[12]	15419	5 ml probówka z korkiem (12 x 85 mm), Sarstedt® 5 ml tube with cap (12 x 85 mm), Sarstedt®
[12]	15120	5 ml probówka szklana (12 x 75 mm) 5 ml glass tube (12 x 75 mm)
<b>14071</b>		
[12]	*	28 ml Thermo Nalgene® Oak Ridge (25,4 x 101,8 mm)
[12]	15055	30 ml probówka z pokrywką (25,4 x 103,2 mm) 30 ml tube with cap (25,4 x 103,2 mm)
[12]	15056	30 ml Thermo Nalgene® Oak Ridge (25,5 x 94,3 mm) 30 ml Thermo Nalgene® Oak Ridge (25,5 x 94,3 mm)
[12]	15424	30 ml probówka z pokrywką (25,5 x 94 mm), Nalgene® 30 ml tube with cap (25,5 x 94 mm), Nalgene®
<b>14073</b>		
[12]	*	BD Vacutainer® (16 x 100 mm), (2,5-11 ml)
[12]	*	Greiner Vacuette® (16 x 100 mm), (7-9 ml)
[12]	*	Sarstedt S-Monovette® (15 x 92 mm), (7,5; 8,2; 8,5 ml)
[12]	*	Sarstedt S-Monovette® (16 x 92 mm), (9; 10 ml)
[12]	15046	14 ml probówka z pokrywką (16,8 x 113,7 mm), Sarstedt® 14 ml tube with cap (16,8 x 113,7 mm), Sarstedt®
[12]	15053	10 ml probówka z pokrywką (16 x 106 mm) 10 ml tube with cap (16 x 106 mm)
[12]	15118	10 ml probówka szklana (16 x 100 mm) 10 ml glass tube (16 x 100 mm)
<b>14089</b>		
[12]	*	15 ml probówka z dnem stożkowym z zakrętką (17 x 120 mm), Falcon®; [15050], 15ml (17 x 120 mm) 15 ml tube, conical bottom, with cap (17 x 120 mm), Falcon®; [15050] 15ml Sarstedt®(17 x 120 mm)

\* probówka niedostępna w ofercie MPW lub dostępny odpowiednik (np.[15050]), patrz kolumna z prawej  
tube is not offered by MPW or equivalent is available (e.g. [15050]), see column on the right



**A. Wyposażenie dodatkowe/Optional accessories****MPW-380/R****14248**

[12] 15055 30 ml probówka z pokrywką (25,4 x 103,2 mm)  
30 ml tube with cap (25,4 x 103,2 mm)

**14089+14868**

[12] \* 5 ml probówka z korkiem wciskany (17 x 54,2 mm), Eppendorf®  
5 ml tube with snap cap (17 x 54,2 mm), Eppendorf®

**bez wkładki/without adapter**

[12] 15051 50 ml Thermo Nalgene® Oak Ridge (28,8 x 106,7 mm)  
50 ml Thermo Nalgene® Oak Ridge (28,8 x 106,7 mm)

[12] \* 50 ml probówka z dnem stożkowym z zakrętką (30 x 117 mm), Falcon®; [15052] 50ml (30 x 117mm)  
50 ml tube, conical bottom, with cap (30 x 117 mm), Falcon®; [15052] 50ml Sarstedt® (30 x 117 mm)

[12] \* 50 ml probówka z dnem stożkowym bez rantu (30 x 115 mm), Greiner®  
50 ml tube, conical bottom, without skirt (30 x 115 mm), Greiner®

[12] \* 50 ml probówka Advanced Oak Ridge (29x102 mm), Herolab® nr 25 32 11  
50 ml tube, Advanced Oak Ridge (29 x 102 mm), Herolab® no. 25 32 11

**11789****RPM 4700, RCF 4297, Rmax 174,  $\phi$  30****13080****14082**

[48] \* BD Vacutainer® (13 x 100 mm), (4-7 ml)

[48] \* Greiner Vacuette® (13 x 100 mm), (3,5-6 ml)

[48] \* Sarstedt S-Monovette® (11 x 92 mm), (4,5; 5 ml)

[48] 15054 6 ml probówka z pokrywką (11,5 x 92 mm), Sarstedt®  
6 ml tube with cap (11,5 x 92 mm), Sarstedt®

[48] 15119 7 ml probówka szklana (12 x 100 mm)  
7 ml glass tube (12 x 100 mm)

**bez wkładki/without adapter**

[48] \* BD Vacutainer® (16 x 100 mm), (2,5-11 ml)

[48] \* Greiner Vacuette® (16 x 100 mm), (7-9 ml)

[48] \* Sarstedt S-Monovette® (15 x 92 mm), (7,5; 8,2; 8,5 ml)

[48] \* Sarstedt S-Monovette® (16 x 92 mm), (9; 10 ml)

[48] 15046 14 ml probówka z pokrywką (16,8 x 113,7 mm), Sarstedt®  
14 ml tube with cap (16,8 x 113,7 mm), Sarstedt®

[48] 15048 15 ml Thermo Nalgene® (16 x 113 mm)  
15 ml Thermo Nalgene® (16 x 113 mm)

[48] 15053 10 ml probówka z pokrywką (16 x 106 mm)  
10 ml tube with cap (16 x 106 mm)

[48] 15118 10 ml probówka szklana (16 x 100 mm)  
10 ml glass tube (16 x 100 mm)

[48] \* 15 ml probówka z dnem stożkowym z zakrętką (17 x 120 mm), Falcon®; [15050], 15ml (17 x 120 mm)  
15 ml tube, conical bottom, with cap (17 x 120 mm), Falcon®; [15050] 15ml Sarstedt®(17 x 120 mm)

**RPM 4700, RCF 4026, Rmax 163,  $\phi$  30****13081****14082**

[48] \* BD Vacutainer® (13 x 75 mm), (1,6-5,3 ml)

[48] \* Greiner Vacuette® (13 x 75 mm), (1-4,5 ml)

[48] \* Sarstedt S-Monovette® (11 x 66 mm), (1,6; 2; 2,7; 3; 3,1 ml)

[48] \* Sarstedt S-Monovette® (13 x 65 mm), (2,6; 2,9; 3,4; 3,8 ml)

[48] \* Sarstedt S-Monovette® (13 x 75 mm), (2,7; 3; 4,3 ml)

[48] 15120 5 ml probówka szklana (12 x 75 mm)  
5 ml glass tube (12 x 75 mm)

**bez wkładki/without adapter**

[48] \* Sarstedt S-Monovette® (15 x 75 mm), (4; 4,3; 5,5 ml)

[48] \* 10 ml Thermo Nalgene® Oak Ridge (16 x 81,5 mm)

[48] 15121 10 ml probówka z dnem okrągłym i pokrywką (17 x 70 mm)  
10 ml tube, round bottom, with cap (17 x 70 mm)

**12787****RPM 4300, RCF 2398, Rmax 116,  $\phi$  90**

\* probówka niedostępna w ofercie MPW lub dostępny odpowiednik (np.[15050]), patrz kolumna z prawej  
tube is not offered by MPW or equivalent is available (e.g. [15050]), see column on the right

**A. Wyposażenie dodatkowe/Optional accessories****MPW-380/R****13286****bez wkładki/without adapter**

- [2] \* płytki titracyjna DWP 96/2000µl (127,8x85,5x44,1 mm)  
deepwell plate DWP 96/2000µl (127,8 x 85,5 x 44,1 mm)
- [4] 15102 płytki titracyjna MTP 28,8ml (86x128x15/17,5 mm)  
microtiter plate MTP 28,8 ml (86 x 128 x 15/17,5 mm)

**12788****RPM 4000, RCF 2826, Rmax 158, 4 90****13789****bez wkładki/without adapter**

- [8] 15102 płytki titracyjna MTP 28,8ml (86x128x15/17,5 mm)  
microtiter plate MTP 28,8 ml (86 x 128 x 15/17,5 mm)
- [4] \* płytki titracyjna DWP 96/2000µl (127,8x85,5x44,1 mm)  
deepwell plate DWP 96/2000µl (127,8 x 85,5 x 44,1 mm)

**12791****RPM 2500, RCF 1293, Rmax 185, 4 90****13792+17792****14794**

- [4] 15797 100 ml pojemnik szklany ASTM (96 x 160 mm)  
100 ml ASTM glass bucket (96 x 160 mm)

**14795**

- [4] 15796 100 ml pojemnik szklany ASTM (96 x 167 mm)  
100 ml ASTM glass bucket (96 x 167 mm)

**12870****RPM 4000, RCF 3309, Rmax 185, 4 90****13831****14121**

- [28] 15222 30 ml probówka z pokrywką (25 x 94mm), Sterilin®  
30 ml tube with cap (25 x 94 mm), Sterilin®
- [28] 15223 30 ml probówka z pokrywką (25 x 94 mm), Sterilin®  
30 ml tube with cap (25 x 94 mm), Sterilin®

**14837**

- [64] \* BD Vacutainer® (16 x 100 mm), (2,5-11 ml)
- [64] \* Greiner Vacuette® (16 x 100 mm), (7-9 ml)
- [64] \* Sarstedt S-Monovette® (15 x 75 mm), (4; 4,3; 5,5 ml)
- [64] \* Sarstedt S-Monovette® (15 x 92 mm), (7,5; 8,2; 8,5 ml)
- [64] \* Sarstedt S-Monovette® (16 x 92 mm), (9; 10 ml)
- [64] \* 10 ml Thermo Nalgene® Oak Ridge (16 x 81,5 mm)
- [64] 15046 14 ml probówka z pokrywką (16,8 x 113,7 mm), Sarstedt®  
14 ml tube with cap (16,8 x 113,7 mm), Sarstedt®
- [64] 15048 15 ml Thermo Nalgene® (16 x 113 mm)  
15 ml Thermo Nalgene® (16 x 113 mm)
- [64] 15053 10 ml probówka z pokrywką (16 x 106 mm)  
10 ml tube with cap (16 x 106 mm)
- [64] 15118 10 ml probówka szklana (16 x 100 mm)  
10 ml glass tube (16 x 100 mm)

**14838**

- [48] \* 15 ml probówka z dnem stożkowym z zakrętką (17 x 120 mm), Falcon®; [15050], 15ml (17 x 120 mm)  
15 ml tube, conical bottom, with cap (17 x 120 mm), Falcon®; [15050] 15ml Sarstedt®(17 x 120 mm)

**14839**

- [32] \* 28 ml Thermo Nalgene® Oak Ridge (25,4 x 101,8 mm)
- [32] 15055 30 ml probówka z pokrywką (25,4 x 103,2 mm)  
30 ml tube with cap (25,4 x 103,2 mm)

## A. Wyposażenie dodatkowe/Optional accessories

### MPW-380/R

[32]	15056	30 ml Thermo Nalgene® Oak Ridge (25,5 x 94,3 mm) 30 ml Thermo Nalgene® Oak Ridge (25,5 x 94,3 mm)
[32]	15117	25 ml probówka szklana (25 x 100 mm) 25 ml glass tube (25 x 100 mm)
[32]	15424	30 ml probówka z pokrywką (25,5 x 94 mm), Nalgene® 30 ml tube with cap (25,5 x 94 mm), Nalgene®
<b>14840</b>		
[20]	*	50 ml probówka z dnem stożkowym z zakrętką (30 x 117 mm), Falcon®; [15052] 50ml (30 x 117mm) 50 ml tube, conical bottom, with cap (30 x 117 mm), Falcon®; [15052] 50ml Sarstedt® (30 x 117 mm)
[20]	*	50 ml probówka z dnem stożkowym bez rantu (30 x 115 mm), Greiner® 50 ml tube, conical bottom, without skirt (30 x 115 mm), Greiner®
<b>14841</b>		
[8]	15040	100 ml probówka z pokrywką (45,2 x 103,7 mm) 100 ml tube with cap (45,2 x 103,7 mm)
[8]	15115	100 ml probówka szklana (44 x 100 mm) 100 ml glass tube (44 x 100 mm)
<b>14844</b>		
[104]	*	2-1,5 ml probówka (10,8x41,8 mm), Eppendorf®; [15011], 2 ml (10,8x41,8 mm); [15128], 1,5ml (10,8x40,5 mm) 2-1,5 ml tube (10,8x41,8 mm), Eppendorf®; [15011], 2 ml (10,8x41,8 mm); [15128], 1,5ml (10,8x40,5 mm)
[104]	*	2 ml probówki z filtrem - spin columns (10,8 x 46 mm) 2 ml spin columns (with filter) (10,8 x 46 mm); [15011], 2 ml (10,8x41,8 mm); [15128], 1,5ml (10,8x40,5 mm)
<b>14860</b>		
[112]	15016	Sarstedt S-Monovette® (8 x 66 mm), (1,1; 1,2; 1,4 ml) Sarstedt S-Monovette® (8 x 66 mm), (1,1; 1,2; 1,4 ml)
<b>14862</b>		
[100]	*	Sarstedt S-Monovette® (11 x 66 mm), (1,6; 2; 2,7; 3; 3,1 ml)
[100]	*	Sarstedt S-Monovette® (11 x 92 mm), (4,5; 5 ml)
[100]	15054	6 ml probówka z pokrywką (11,5 x 92 mm), Sarstedt® 6 ml tube with cap (11,5 x 92 mm), Sarstedt®
[100]	15119	7 ml probówka szklana (12 x 100 mm) 7 ml glass tube (12 x 100 mm)
[100]	15120	5 ml probówka szklana (12 x 75 mm) 5 ml glass tube (12 x 75 mm)
[100]	15419	5 ml probówka z korkiem (12 x 85 mm), Sarstedt® 5 ml tube with cap (12 x 85 mm), Sarstedt®
<b>14863</b>		
[96]	*	Sarstedt S-Monovette® (11 x 92 mm), (4,5; 5 ml)
[96]	*	BD Vacutainer® (13 x 75 mm), (1,6-5,3 ml)
[96]	*	BD Vacutainer® (13 x 100 mm), (4-7 ml)
[96]	*	Greiner Vacuette® (13 x 75 mm), (1-4,5 ml)
[96]	*	Greiner Vacuette® (13 x 100 mm), (3,5-6 ml)
[96]	*	Sarstedt S-Monovette® (13 x 75 mm), (2,7; 3; 4,3 ml)
[96]	*	Sarstedt S-Monovette® (13 x 65 mm), (2,6; 2,9; 3,4; 3,8 ml)
[96]	*	Sarstedt S-Monovette® (13 x 90 mm), (4,9; 5,6 ml)
[96]	15054	6 ml probówka z pokrywką (11,5 x 92 mm), Sarstedt® 6 ml tube with cap (11,5 x 92 mm), Sarstedt®
[96]	15120	5 ml probówka szklana (12 x 75 mm) 5 ml glass tube (12 x 75 mm)
[96]	15419	5 ml probówka z korkiem (12 x 85 mm), Sarstedt® 5 ml tube with cap (12 x 85 mm), Sarstedt®
<b>14842+14017</b>		
[4]	15129	250 ml butelka okrągłodenna (62 x 122 mm), Herolab® nr 25 34 43 250 ml round-bottom bottle (62 x 122 mm), Herolab® no. 25 34 43
<b>14842+14175</b>		
[4]	15175	250 ml butelka płaskodenna (62 x 122 mm), Herolab® nr 25 34 21 250 ml bottle, flat bottom (62 x 122 mm), Herolab® no. 25 34 21
[4]	15176	250 ml butelka płaskodenna (62 x 122 mm), Herolab® nr 25 34 01 250 ml bottle, flat bottom (62 x 122 mm), Herolab® no. 25 34 01
<b>13833</b>		
<b>14845</b>		
[72]	*	BD Vacutainer® (13 x 75 mm), (1,6-5,3 ml)
[72]	*	BD Vacutainer® (13 x 100 mm), (4-7 ml)
[72]	*	Greiner Vacuette® (13 x 75 mm), (1-4,5 ml)
[72]	*	Greiner Vacuette® (13 x 100 mm), (3,5-6 ml)
[72]	*	Sarstedt S-Monovette® (11 x 66 mm), (1,6; 2; 2,7; 3; 3,1 ml)
[72]	*	Sarstedt S-Monovette® (13 x 65 mm), (2,6; 2,9; 3,4; 3,8 ml)
[72]	*	Sarstedt S-Monovette® (13 x 75 mm), (2,7; 3; 4,3 ml)
[72]	*	Sarstedt S-Monovette® (11 x 92 mm), (4,5; 5 ml)
[72]	*	Sarstedt S-Monovette® (13 x 90 mm), (4,9; 5,6 ml)

\* probówka niedostępna w ofercie MPW lub dostępny odpowiednik (np.[15050]), patrz kolumna z prawej  
tube is not offered by MPW or equivalent is available (e.g. [15050]), see column on the right

**A. Wyposażenie dodatkowe/Optional accessories****MPW-380/R**

[72]	15054	6 ml probówka z pokrywką (11,5 x 92 mm), Sarstedt® 6 ml tube with cap (11,5 x 92 mm), Sarstedt®
[72]	15120	5 ml probówka szklana (12 x 75 mm) 5 ml glass tube (12 x 75 mm)
[72]	15419	5 ml probówka z korkiem (12 x 85 mm), Sarstedt® 5 ml tube with cap (12 x 85 mm), Sarstedt®
[72]	15119	7 ml probówka szklana (12 x 100 mm) 7 ml glass tube (12 x 100 mm)
<b>14846</b>		
[48]	*	Greiner Vacuette® (16 x 100 mm), (7-9 ml)
[48]	*	Sarstedt S-Monovette® (15 x 92 mm), (7,5; 8,2; 8,5 ml)
[48]	*	10 ml Thermo Nalgene® Oak Ridge (16 x 81,5 mm)
[48]	15046	14 ml probówka z pokrywką (16,8 x 113,7 mm), Sarstedt® 14 ml tube with cap (16,8 x 113,7 mm), Sarstedt®
[48]	15053	10 ml probówka z pokrywką (16 x 106 mm) 10 ml tube with cap (16 x 106 mm)
[48]	15118	10 ml probówka szklana (16 x 100 mm) 10 ml glass tube (16 x 100 mm)
<b>14847</b>		
[48]	15050	15 ml probówka z dnem stożkowym z zakrętką (17 x 120 mm), Sarstedt® 15 ml tube, conical bottom, with cap (17 x 120 mm), Sarstedt®
<b>14848</b>		
[20]	*	28 ml Thermo Nalgene® Oak Ridge (25,4 x 101,8 mm)
[20]	15055	30 ml probówka z pokrywką (25,4 x 103,2 mm) 30 ml tube with cap (25,4 x 103,2 mm)
[20]	15056	30 ml Thermo Nalgene® Oak Ridge (25,5 x 94,3 mm) 30 ml Thermo Nalgene® Oak Ridge (25,5 x 94,3 mm)
[20]	15117	25 ml probówka szklana (25 x 100 mm) 25 ml glass tube (25 x 100 mm)
<b>14849</b>		
[16]	*	50 ml probówka z dnem stożkowym z zakrętką (30 x 117 mm), Falcon®; [15052] 50ml (30 x 117mm) 50 ml tube, conical bottom, with cap (30 x 117 mm), Falcon®; [15052] 50ml Sarstedt® (30 x 117 mm)
[16]	*	50 ml probówka z dnem stożkowym bez rantu (30 x 115 mm), Greiner® 50 ml tube, conical bottom, without skirt (30 x 115 mm), Greiner®
<b>14850</b>		
[4]	15115	100 ml probówka szklana (44 x 100 mm) 100 ml glass tube (44 x 100 mm)
[4]	15040	100 ml probówka z pokrywką (45,2 x 103,7 mm) 100 ml tube with cap (45,2 x 103,7 mm)
<b>14853</b>		
[84]	*	2-1,5 ml probówka (10,8x41,8 mm), Eppendorf®; [15011], 2 ml (10,8x41,8 mm); [15128], 1,5ml (10,8x40,5 mm) 2-1,5 ml tube (10,8x41,8 mm), Eppendorf®; [15011], 2 ml (10,8x41,8 mm); [15128], 1,5ml (10,8x40,5 mm)
[84]	*	2 ml probówki z filtrem - spin columns (10,8 x 46 mm) 2 ml spin columns (with filter) (10,8 x 46 mm); [15011], 2 ml (10,8x41,8 mm); [15128], 1,5ml (10,8x40,5 mm)
<b>14854</b>		
[4]	15440	200 ml butelka płaskodenna (56 x 112 mm), Herolab® nr 25 33 73 200 ml bottle, flat bottom (56 x 112 mm), Herolab® no. 25 33 73
<b>14859</b>		
[12]	15116	50 ml probówka szklana (35 x 100 mm) 50 ml glass tube (35 x 100 mm)
<b>14861</b>		
[96]	15016	Sarstedt S-Monovette® (8 x 66 mm), (1,1; 1,2; 1,4 ml) Sarstedt S-Monovette® (8 x 66 mm), (1,1; 1,2; 1,4 ml)
<b>14867</b>		
[36]	*	15 ml probówka z dnem stożkowym z zakrętką (17 x 120 mm), Falcon®; [15050], 15ml (17 x 120 mm) 15 ml tube, conical bottom, with cap (17 x 120 mm), Falcon®; [15050] 15ml Sarstedt®(17 x 120 mm)
<b>14850+14159</b>		
[4]	15116	50 ml probówka szklana (35 x 100 mm) 50 ml glass tube (35 x 100 mm)
<b>14851+14017</b>		
[4]	15129	250 ml butelka okrągłodenna (62 x 122 mm), Herolab® nr 25 34 43 250 ml round-bottom bottle (62 x 122 mm), Herolab® no. 25 34 43
<b>14851+14175</b>		
[4]	15175	250 ml butelka płaskodenna (62 x 122 mm), Herolab® nr 25 34 21 250 ml bottle, flat bottom (62 x 122 mm), Herolab® no. 25 34 21
[4]	15176	250 ml butelka płaskodenna (62 x 122 mm), Herolab® nr 25 34 01 250 ml bottle, flat bottom (62 x 122 mm), Herolab® no. 25 34 01
<b>bez wkładki/without adapter</b>		
[4]	15852	500 ml butelka (84 x 135 mm), Herolab® nr 25 36 11 500 ml bottle (84 x 135 mm), Herolab® no. 25 36 11

**A. Wyposażenie dodatkowe/Optional accessories****MPW-380/R****13865****14043**

- [28] \* Greiner Vacuette® (13 x 75 mm), (1-4,5 ml)  
[28] 15120 5 ml probówka szklana (12 x 75 mm)  
5 ml glass tube (12 x 75 mm)  
[28] 15419 5 ml probówka z korkiem (12 x 85 mm), Sarstedt®  
5 ml tube with cap (12 x 85 mm), Sarstedt®

**14071**

- [28] \* 28 ml Thermo Nalgene® Oak Ridge (25,4 x 101,8 mm)  
[28] 15055 30 ml probówka z pokrywką (25,4 x 103,2 mm)  
30 ml tube with cap (25,4 x 103,2 mm)  
[28] 15056 30 ml Thermo Nalgene® Oak Ridge (25,5 x 94,3 mm)  
30 ml Thermo Nalgene® Oak Ridge (25,5 x 94,3 mm)  
[28] 15117 25 ml probówka szklana (25 x 100 mm)  
25 ml glass tube (25 x 100 mm)  
[28] 15424 30 ml probówka z pokrywką (25,5 x 94 mm), Nalgene®  
30 ml tube with cap (25,5 x 94 mm), Nalgene®

**14073**

- [28] \* BD Vacutainer® (16 x 100 mm), (2,5-11 ml)  
[28] \* Greiner Vacuette® (16 x 100 mm), (7-9 ml)  
[28] \* Sarstedt S-Monovette® (15 x 92 mm), (7,5; 8,2; 8,5 ml)  
[28] \* Sarstedt S-Monovette® (16 x 92 mm), (9; 10 ml)  
[28] 15048 15 ml Thermo Nalgene® (16 x 113 mm)  
15 ml Thermo Nalgene® (16 x 113 mm)  
[28] 15053 10 ml probówka z pokrywką (16 x 106 mm)  
10 ml tube with cap (16 x 106 mm)  
[28] 15118 10 ml probówka szklana (16 x 100 mm)  
10 ml glass tube (16 x 100 mm)  
[28] 15046 14 ml probówka z pokrywką (16,8 x 113,7 mm), Sarstedt®  
14 ml tube with cap (16,8 x 113,7 mm), Sarstedt®

**14089**

- [4] \* 15 ml probówka z dnem stożkowym z zakrętką (17 x 120 mm), Falcon®; [15050], 15ml (17 x 120 mm)  
15 ml tube, conical bottom, with cap (17 x 120 mm), Falcon®; [15050] 15ml Sarstedt® (17 x 120 mm)  
**bez wkładki/without adapter**  
[28] \* 50 ml probówka z dnem stożkowym z zakrętką (30 x 117 mm), Falcon®; [15052] 50ml (30 x 117mm)  
50 ml tube, conical bottom, with cap (30 x 117 mm), Falcon®; [15052] 50ml Sarstedt® (30 x 117 mm)  
[28] \* 50 ml probówka z dnem stożkowym bez rantu (30 x 115 mm), Greiner®  
50 ml tube, conical bottom, without skirt (30 x 115 mm), Greiner®

**13866****14043**

- [24] \* Greiner Vacuette® (13 x 75 mm), (1-4,5 ml)  
[24] 15120 5 ml probówka szklana (12 x 75 mm)  
5 ml glass tube (12 x 75 mm)  
[24] 15419 5 ml probówka z korkiem (12 x 85 mm), Sarstedt®  
5 ml tube with cap (12 x 85 mm), Sarstedt®

**14071**

- [24] \* 28 ml Thermo Nalgene® Oak Ridge (25,4 x 101,8 mm)  
[24] 15055 30 ml probówka z pokrywką (25,4 x 103,2 mm)  
30 ml tube with cap (25,4 x 103,2 mm)  
[24] 15056 30 ml Thermo Nalgene® Oak Ridge (25,5 x 94,3 mm)  
30 ml Thermo Nalgene® Oak Ridge (25,5 x 94,3 mm)  
[24] 15117 25 ml probówka szklana (25 x 100 mm)  
25 ml glass tube (25 x 100 mm)  
[24] 15424 30 ml probówka z pokrywką (25,5 x 94 mm), Nalgene®  
30 ml tube with cap (25,5 x 94 mm), Nalgene®

**14073**

- [24] \* BD Vacutainer® (16 x 100 mm), (2,5-11 ml)  
[24] \* Greiner Vacuette® (16 x 100 mm), (7-9 ml)  
[24] \* Sarstedt S-Monovette® (15 x 92 mm), (7,5; 8,2; 8,5 ml)  
[24] \* Sarstedt S-Monovette® (16 x 92 mm), (9; 10 ml)  
[24] 15046 14 ml probówka z pokrywką (16,8 x 113,7 mm), Sarstedt®  
14 ml tube with cap (16,8 x 113,7 mm), Sarstedt®  
[24] 15048 15 ml Thermo Nalgene® (16 x 113 mm)  
15 ml Thermo Nalgene® (16 x 113 mm)  
[24] 15053 10 ml probówka z pokrywką (16 x 106 mm)  
10 ml tube with cap (16 x 106 mm)  
[24] 15118 10 ml probówka szklana (16 x 100 mm)  
10 ml glass tube (16 x 100 mm)

**A. Wyposażenie dodatkowe/Optional accessories****MPW-380/R****14089**

- [4] \* 15 ml probówka z dnem stożkowym z zakrętką (17 x 120 mm), Falcon®; [15050], 15ml (17 x 120 mm)  
15 ml tube, conical bottom, with cap (17 x 120 mm), Falcon®; [15050] 15ml Sarstedt®(17 x 120 mm)

**bez wkładki/without adapter**

- [24] \* 50 ml probówka z dnem stożkowym z zakrętką (30 x 117 mm), Falcon®; [15052] 50ml (30 x 117mm)  
50 ml tube, conical bottom, with cap (30 x 117 mm), Falcon®; [15052] 50ml Sarstedt® (30 x 117 mm)
- [24] \* 50 ml probówka z dnem stożkowym bez rantu (30 x 115 mm), Greiner®  
50 ml tube, conical bottom, without skirt (30 x 115 mm), Greiner®

**13831+17832****14121**

- [28] 15222 30 ml probówka z pokrywką (25 x 94mm), Sterilin®  
30 ml tube with cap (25 x 94 mm), Sterilin®
- [28] 15223 30 ml probówka z pokrywką (25 x 94 mm), Sterilin®  
30 ml tube with cap (25 x 94 mm), Sterilin®

**14837**

- [64] \* BD Vacutainer® (16 x 100 mm), (2,5-11 ml)
- [64] \* Greiner Vacuette® (16 x 100 mm), (7-9 ml)
- [64] \* Sarstedt S-Monovette® (15 x 75 mm), (4; 4,3; 5,5 ml)
- [64] \* Sarstedt S-Monovette® (15 x 92 mm), (7,5; 8,2; 8,5 ml)
- [64] \* Sarstedt S-Monovette® (16 x 92 mm), (9; 10 ml)
- [64] \* 10 ml Thermo Nalgene® Oak Ridge (16 x 81,5 mm)
- [64] 15046 14 ml probówka z pokrywką (16,8 x 113,7 mm), Sarstedt®  
14 ml tube with cap (16,8 x 113,7 mm), Sarstedt®
- [64] 15048 15 ml Thermo Nalgene® (16 x 113 mm)  
15 ml Thermo Nalgene® (16 x 113 mm)
- [64] 15053 10 ml probówka z pokrywką (16 x 106 mm)  
10 ml tube with cap (16 x 106 mm)
- [64] 15118 10 ml probówka szklana (16 x 100 mm)  
10 ml glass tube (16 x 100 mm)

**14838**

- [48] \* 15 ml probówka z dnem stożkowym z zakrętką (17 x 120 mm), Falcon®; [15050], 15ml (17 x 120 mm)  
15 ml tube, conical bottom, with cap (17 x 120 mm), Falcon®; [15050] 15ml Sarstedt®(17 x 120 mm)

**14839**

- [32] \* 28 ml Thermo Nalgene® Oak Ridge (25,4 x 101,8 mm)
- [32] 15055 30 ml probówka z pokrywką (25,4 x 103,2 mm)  
30 ml tube with cap (25,4 x 103,2 mm)
- [32] 15056 30 ml Thermo Nalgene® Oak Ridge (25,5 x 94,3 mm)  
30 ml Thermo Nalgene® Oak Ridge (25,5 x 94,3 mm)
- [32] 15117 25 ml probówka szklana (25 x 100 mm)  
25 ml glass tube (25 x 100 mm)
- [32] 15424 30 ml probówka z pokrywką (25,5 x 94 mm), Nalgene®  
30 ml tube with cap (25,5 x 94 mm), Nalgene®

**14840**

- [20] \* 50 ml probówka z dnem stożkowym z zakrętką (30 x 117 mm), Falcon®; [15052] 50ml (30 x 117mm)  
50 ml tube, conical bottom, with cap (30 x 117 mm), Falcon®; [15052] 50ml Sarstedt® (30 x 117 mm)
- [20] \* 50 ml probówka z dnem stożkowym bez rantu (30 x 115 mm), Greiner®  
50 ml tube, conical bottom, without skirt (30 x 115 mm), Greiner®

**14841**

- [8] 15040 100 ml probówka z pokrywką (45,2 x 103,7 mm)  
100 ml tube with cap (45,2 x 103,7 mm)
- [8] 15115 100 ml probówka szklana (44 x 100 mm)  
100 ml glass tube (44 x 100 mm)

**14844**

- [104] \* 2-1,5 ml probówka (10,8x41,8 mm), Eppendorf®; [15011], 2 ml (10,8x41,8 mm); [15128], 1,5ml (10,8x40,5 mm)  
2-1,5 ml tube (10,8x41,8 mm), Eppendorf®; [15011], 2 ml (10,8x41,8 mm); [15128], 1,5ml (10,8x40,5 mm)
- [104] \* 2 ml probówki z filtrem - spin columns (10,8 x 46 mm)  
2 ml spin columns (with filter) (10,8 x 46 mm); [15011], 2 ml (10,8x41,8 mm); [15128], 1,5ml (10,8x40,5 mm)

**14860**

- [112] 15016 Sarstedt S-Monovette® (8 x 66 mm), (1,1; 1,2; 1,4 ml)  
Sarstedt S-Monovette® (8 x 66 mm), (1,1; 1,2; 1,4 ml)

**14862**

- [100] \* Sarstedt S-Monovette® (11 x 66 mm), (1,6; 2; 2,7; 3; 3,1 ml)
- [100] \* Sarstedt S-Monovette® (11 x 92 mm), (4,5; 5 ml)
- [100] 15054 6 ml probówka z pokrywką (11,5 x 92 mm), Sarstedt®  
6 ml tube with cap (11,5 x 92 mm), Sarstedt®
- [100] 15119 7 ml probówka szklana (12 x 100 mm)  
7 ml glass tube (12 x 100 mm)
- [100] 15120 5 ml probówka szklana (12 x 75 mm)  
5 ml glass tube (12 x 75 mm)

**A. Wyposażenie dodatkowe/Optional accessories****MPW-380/R**

[100] 15419 5 ml probówka z korkiem (12 x 85 mm), Sarstedt®  
5 ml tube with cap (12 x 85 mm), Sarstedt®

**14863**

[96] \* Sarstedt S-Monovette® (11 x 92 mm), (4,5; 5 ml)

[96] \* BD Vacutainer® (13 x 75 mm), (1,6-5,3 ml)

[96] \* BD Vacutainer® (13 x 100 mm), (4-7 ml)

[96] \* Greiner Vacuette® (13 x 75 mm), (1-4,5 ml)

[96] \* Greiner Vacuette® (13 x 100 mm), (3,5-6 ml)

[96] \* Sarstedt S-Monovette® (13 x 75 mm), (2,7; 3; 4,3 ml)

[96] \* Sarstedt S-Monovette® (13 x 65 mm), (2,6; 2,9; 3,4; 3,8 ml)

[96] \* Sarstedt S-Monovette® (13 x 90 mm), (4,9; 5,6 ml)

[96] 15054 6 ml probówka z pokrywką (11,5 x 92 mm), Sarstedt®

6 ml tube with cap (11,5 x 92 mm), Sarstedt®

[96] 15120 5 ml probówka szklana (12 x 75 mm)

5 ml glass tube (12 x 75 mm)

[96] 15419 5 ml probówka z korkiem (12 x 85 mm), Sarstedt®

5 ml tube with cap (12 x 85 mm), Sarstedt®

**14842+14017**

[4] 15129 250 ml butelka okrągłodenna (62 x 122 mm), Herolab® nr 25 34 43

250 ml round-bottom bottle (62 x 122 mm), Herolab® no. 25 34 43

**14842+14175**

[4] 15175 250 ml butelka płaskodenna (62 x 122 mm), Herolab® nr 25 34 21

250 ml bottle, flat bottom (62 x 122 mm), Herolab® no. 25 34 21

[4] 15176 250 ml butelka płaskodenna (62 x 122 mm), Herolab® nr 25 34 01

250 ml bottle, flat bottom (62 x 122 mm), Herolab® no. 25 34 01

**13833+17834****14845**

[72] \* BD Vacutainer® (13 x 75 mm), (1,6-5,3 ml)

[72] \* BD Vacutainer® (13 x 100 mm), (4-7 ml)

[72] \* Greiner Vacuette® (13 x 75 mm), (1-4,5 ml)

[72] \* Greiner Vacuette® (13 x 100 mm), (3,5-6 ml)

[72] \* Sarstedt S-Monovette® (11 x 66 mm), (1,6; 2; 2,7; 3; 3,1 ml)

[72] \* Sarstedt S-Monovette® (13 x 65 mm), (2,6; 2,9; 3,4; 3,8 ml)

[72] \* Sarstedt S-Monovette® (13 x 75 mm), (2,7; 3; 4,3 ml)

[72] \* Sarstedt S-Monovette® (11 x 92 mm), (4,5; 5 ml)

[72] \* Sarstedt S-Monovette® (13 x 90 mm), (4,9; 5,6 ml)

[72] 15054 6 ml probówka z pokrywką (11,5 x 92 mm), Sarstedt®

6 ml tube with cap (11,5 x 92 mm), Sarstedt®

[72] 15120 5 ml probówka szklana (12 x 75 mm)

5 ml glass tube (12 x 75 mm)

[72] 15419 5 ml probówka z korkiem (12 x 85 mm), Sarstedt®

5 ml tube with cap (12 x 85 mm), Sarstedt®

[72] 15119 7 ml probówka szklana (12 x 100 mm)

7 ml glass tube (12 x 100 mm)

**14846**

[48] \* Greiner Vacuette® (16 x 100 mm), (7-9 ml)

[48] \* Sarstedt S-Monovette® (15 x 92 mm), (7,5; 8,2; 8,5 ml)

[48] \* 10 ml Thermo Nalgene® Oak Ridge (16 x 81,5 mm)

[48] 15046 14 ml probówka z pokrywką (16,8 x 113,7 mm), Sarstedt®

14 ml tube with cap (16,8 x 113,7 mm), Sarstedt®

[48] 15053 10 ml probówka z pokrywką (16 x 106 mm)

10 ml tube with cap (16 x 106 mm)

[48] 15118 10 ml probówka szklana (16 x 100 mm)

10 ml glass tube (16 x 100 mm)

**14847**

[48] 15050 15 ml probówka z dnem stożkowym z zakrętką (17 x 120 mm), Sarstedt®

15 ml tube, conical bottom, with cap (17 x 120 mm), Sarstedt®

**14848**

[20] \* 28 ml Thermo Nalgene® Oak Ridge (25,4 x 101,8 mm)

[20] 15055 30 ml probówka z pokrywką (25,4 x 103,2 mm)

30 ml tube with cap (25,4 x 103,2 mm)

[20] 15056 30 ml Thermo Nalgene® Oak Ridge (25,5 x 94,3 mm)

30 ml Thermo Nalgene® Oak Ridge (25,5 x 94,3 mm)

[20] 15117 25 ml probówka szklana (25 x 100 mm)

25 ml glass tube (25 x 100 mm)

**14849**

[16] \* 50 ml probówka z dnem stożkowym z zakrętką (30 x 117 mm), Falcon®; [15052] 50ml (30 x 117mm)

50 ml tube, conical bottom, with cap (30 x 117 mm), Falcon®; [15052] 50ml Sarstedt® (30 x 117 mm)

**A. Wyposażenie dodatkowe/Optional accessories****MPW-380/R**

[16]	*	50 ml probówka z dnem stożkowym bez rantu (30 x 115 mm), Greiner® 50 ml tube, conical bottom, without skirt (30 x 115 mm), Greiner®
<b>14850</b>		
[4]	15115	100 ml probówka szklana (44 x 100 mm) 100 ml glass tube (44 x 100 mm)
[4]	15040	100 ml probówka z pokrywką (45,2 x 103,7 mm) 100 ml tube with cap (45,2 x 103,7 mm)
<b>14853</b>		
[84]	*	2-1,5 ml probówka (10,8x41,8 mm), Eppendorf®; [15011], 2 ml (10,8x41,8 mm); [15128], 1,5ml (10,8x40,5 mm) 2-1,5 ml tube (10,8x41,8 mm), Eppendorf®; [15011], 2 ml (10,8x41,8 mm); [15128], 1,5ml (10,8x40,5 mm)
[84]	*	2 ml probówki z filtrem - spin columns (10,8 x 46 mm) 2 ml spin columns (with filter) (10,8 x 46 mm); [15011], 2 ml (10,8x41,8 mm); [15128], 1,5ml (10,8x40,5 mm)
<b>14854</b>		
[4]	15440	200 ml butelka płaskodenna (56 x 112 mm), Herolab® nr 25 33 73 200 ml bottle, flat bottom (56 x 112 mm), Herolab® no. 25 33 73
<b>14859</b>		
[12]	15116	50 ml probówka szklana (35 x 100 mm) 50 ml glass tube (35 x 100 mm)
<b>14861</b>		
[96]	15016	Sarstedt S-Monovette® (8 x 66 mm), (1,1; 1,2; 1,4 ml) Sarstedt S-Monovette® (8 x 66 mm), (1,1; 1,2; 1,4 ml)
<b>14867</b>		
[36]	*	15 ml probówka z dnem stożkowym z zakrętką (17 x 120 mm), Falcon®; [15050], 15ml (17 x 120 mm) 15 ml tube, conical bottom, with cap (17 x 120 mm), Falcon®; [15050] 15ml Sarstedt®(17 x 120 mm)
<b>14850+14159</b>		
[4]	15116	50 ml probówka szklana (35 x 100 mm) 50 ml glass tube (35 x 100 mm)
<b>14851+14017</b>		
[4]	15129	250 ml butelka okrągłodenna (62 x 122 mm), Herolab® nr 25 34 43 250 ml round-bottom bottle (62 x 122 mm), Herolab® no. 25 34 43
<b>14851+14175</b>		
[4]	15175	250 ml butelka płaskodenna (62 x 122 mm), Herolab® nr 25 34 21 250 ml bottle, flat bottom (62 x 122 mm), Herolab® no. 25 34 21
[4]	15176	250 ml butelka płaskodenna (62 x 122 mm), Herolab® nr 25 34 01 250 ml bottle, flat bottom (62 x 122 mm), Herolab® no. 25 34 01
<b>bez wkładki/without adapter</b>		
[4]	15852	500 ml butelka (84 x 135 mm), Herolab® nr 25 36 11 500 ml bottle (84 x 135 mm), Herolab® no. 25 36 11

**RPM 4300, RCF 3824, Rmax 185, ɸ 90****13831****14121**

[28]	15222	30 ml probówka z pokrywką (25 x 94mm), Sterilin® 30 ml tube with cap (25 x 94 mm), Sterilin®
[28]	15223	30 ml probówka z pokrywką (25 x 94 mm), Sterilin® 30 ml tube with cap (25 x 94 mm), Sterilin®

**14837**

[64]	*	BD Vacutainer® (16 x 100 mm), (2,5-11 ml)
[64]	*	Greiner Vacuette® (16 x 100 mm), (7-9 ml)
[64]	*	Sarstedt S-Monovette® (15 x 75 mm), (4; 4,3; 5,5 ml)
[64]	*	Sarstedt S-Monovette® (15 x 92 mm), (7,5; 8,2; 8,5 ml)
[64]	*	Sarstedt S-Monovette® (16 x 92 mm), (9; 10 ml)
[64]	*	10 ml Thermo Nalgene® Oak Ridge (16 x 81,5 mm)
[64]	15046	14 ml probówka z pokrywką (16,8 x 113,7 mm), Sarstedt® 14 ml tube with cap (16,8 x 113,7 mm), Sarstedt®
[64]	15048	15 ml Thermo Nalgene® (16 x 113 mm) 15 ml Thermo Nalgene® (16 x 113 mm)
[64]	15053	10 ml probówka z pokrywką (16 x 106 mm) 10 ml tube with cap (16 x 106 mm)
[64]	15118	10 ml probówka szklana (16 x 100 mm) 10 ml glass tube (16 x 100 mm)

**14838**

[48]	*	15 ml probówka z dnem stożkowym z zakrętką (17 x 120 mm), Falcon®; [15050], 15ml (17 x 120 mm) 15 ml tube, conical bottom, with cap (17 x 120 mm), Falcon®; [15050] 15ml Sarstedt®(17 x 120 mm)
------	---	--

**14839**

[32]	*	28 ml Thermo Nalgene® Oak Ridge (25,4 x 101,8 mm)
[32]	15055	30 ml probówka z pokrywką (25,4 x 103,2 mm) 30 ml tube with cap (25,4 x 103,2 mm)



## A. Wyposażenie dodatkowe/Optional accessories

### MPW-380/R

[32]	15056	30 ml Thermo Nalgene® Oak Ridge (25,5 x 94,3 mm) 30 ml Thermo Nalgene® Oak Ridge (25,5 x 94,3 mm)
[32]	15117	25 ml probówka szklana (25 x 100 mm) 25 ml glass tube (25 x 100 mm)
[32]	15424	30 ml probówka z pokrywką (25,5 x 94 mm), Nalgene® 30 ml tube with cap (25,5 x 94 mm), Nalgene®
<b>14840</b>		
[20]	*	50 ml probówka z dnem stożkowym z zakrętką (30 x 117 mm), Falcon®; [15052] 50ml (30 x 117mm) 50 ml tube, conical bottom, with cap (30 x 117 mm), Falcon®; [15052] 50ml Sarstedt® (30 x 117 mm)
[20]	*	50 ml probówka z dnem stożkowym bez rantu (30 x 115 mm), Greiner® 50 ml tube, conical bottom, without skirt (30 x 115 mm), Greiner®
<b>14841</b>		
[8]	15040	100 ml probówka z pokrywką (45,2 x 103,7 mm) 100 ml tube with cap (45,2 x 103,7 mm)
[8]	15115	100 ml probówka szklana (44 x 100 mm) 100 ml glass tube (44 x 100 mm)
<b>14844</b>		
[104]	*	2-1,5 ml probówka (10,8x41,8 mm), Eppendorf®; [15011], 2 ml (10,8x41,8 mm); [15128], 1,5ml (10,8x40,5 mm) 2-1,5 ml tube (10,8x41,8 mm), Eppendorf®; [15011], 2 ml (10,8x41,8 mm); [15128], 1,5ml (10,8x40,5 mm)
[104]	*	2 ml probówki z filtrem - spin columns (10,8 x 46 mm) 2 ml spin columns (with filter) (10,8 x 46 mm); [15011], 2 ml (10,8x41,8 mm); [15128], 1,5ml (10,8x40,5 mm)
<b>14860</b>		
[112]	15016	Sarstedt S-Monovette® (8 x 66 mm), (1,1; 1,2; 1,4 ml) Sarstedt S-Monovette® (8 x 66 mm), (1,1; 1,2; 1,4 ml)
<b>14862</b>		
[100]	*	Sarstedt S-Monovette® (11 x 66 mm), (1,6; 2; 2,7; 3; 3,1 ml)
[100]	*	Sarstedt S-Monovette® (11 x 92 mm), (4,5; 5 ml)
[100]	15054	6 ml probówka z pokrywką (11,5 x 92 mm), Sarstedt® 6 ml tube with cap (11,5 x 92 mm), Sarstedt®
[100]	15119	7 ml probówka szklana (12 x 100 mm) 7 ml glass tube (12 x 100 mm)
[100]	15120	5 ml probówka szklana (12 x 75 mm) 5 ml glass tube (12 x 75 mm)
[100]	15419	5 ml probówka z korkiem (12 x 85 mm), Sarstedt® 5 ml tube with cap (12 x 85 mm), Sarstedt®
<b>14863</b>		
[96]	*	Sarstedt S-Monovette® (11 x 92 mm), (4,5; 5 ml)
[96]	*	BD Vacutainer® (13 x 75 mm), (1,6-5,3 ml)
[96]	*	BD Vacutainer® (13 x 100 mm), (4-7 ml)
[96]	*	Greiner Vacuette® (13 x 75 mm), (1-4,5 ml)
[96]	*	Greiner Vacuette® (13 x 100 mm), (3,5-6 ml)
[96]	*	Sarstedt S-Monovette® (13 x 75 mm), (2,7; 3; 4,3 ml)
[96]	*	Sarstedt S-Monovette® (13 x 65 mm), (2,6; 2,9; 3,4; 3,8 ml)
[96]	*	Sarstedt S-Monovette® (13 x 90 mm), (4,9; 5,6 ml)
[96]	15054	6 ml probówka z pokrywką (11,5 x 92 mm), Sarstedt® 6 ml tube with cap (11,5 x 92 mm), Sarstedt®
[96]	15120	5 ml probówka szklana (12 x 75 mm) 5 ml glass tube (12 x 75 mm)
[96]	15419	5 ml probówka z korkiem (12 x 85 mm), Sarstedt® 5 ml tube with cap (12 x 85 mm), Sarstedt®
<b>14842+14017</b>		
[4]	15129	250 ml butelka okrągłodenna (62 x 122 mm), Herolab® nr 25 34 43 250 ml round-bottom bottle (62 x 122 mm), Herolab® no. 25 34 43
<b>14842+14175</b>		
[4]	15175	250 ml butelka płaskodenna (62 x 122 mm), Herolab® nr 25 34 21 250 ml bottle, flat bottom (62 x 122 mm), Herolab® no. 25 34 21
[4]	15176	250 ml butelka płaskodenna (62 x 122 mm), Herolab® nr 25 34 01 250 ml bottle, flat bottom (62 x 122 mm), Herolab® no. 25 34 01
<b>13833</b>		
<b>14845</b>		
[72]	*	BD Vacutainer® (13 x 75 mm), (1,6-5,3 ml)
[72]	*	BD Vacutainer® (13 x 100 mm), (4-7 ml)
[72]	*	Greiner Vacuette® (13 x 75 mm), (1-4,5 ml)
[72]	*	Greiner Vacuette® (13 x 100 mm), (3,5-6 ml)
[72]	*	Sarstedt S-Monovette® (11 x 66 mm), (1,6; 2; 2,7; 3; 3,1 ml)
[72]	*	Sarstedt S-Monovette® (13 x 65 mm), (2,6; 2,9; 3,4; 3,8 ml)
[72]	*	Sarstedt S-Monovette® (13 x 75 mm), (2,7; 3; 4,3 ml)
[72]	*	Sarstedt S-Monovette® (11 x 92 mm), (4,5; 5 ml)
[72]	*	Sarstedt S-Monovette® (13 x 90 mm), (4,9; 5,6 ml)

\* probówka niedostępna w ofercie MPW lub dostępny odpowiednik (np.[15050]), patrz kolumna z prawej  
tube is not offered by MPW or equivalent is available (e.g. [15050]), see column on the right

**A. Wyposażenie dodatkowe/Optional accessories****MPW-380/R**

[72]	15054	6 ml probówka z pokrywką (11,5 x 92 mm), Sarstedt® 6 ml tube with cap (11,5 x 92 mm), Sarstedt®
[72]	15120	5 ml probówka szklana (12 x 75 mm) 5 ml glass tube (12 x 75 mm)
[72]	15419	5 ml probówka z korkiem (12 x 85 mm), Sarstedt® 5 ml tube with cap (12 x 85 mm), Sarstedt®
[72]	15119	7 ml probówka szklana (12 x 100 mm) 7 ml glass tube (12 x 100 mm)
<b>14846</b>		
[48]	*	Greiner Vacuette® (16 x 100 mm), (7-9 ml)
[48]	*	Sarstedt S-Monovette® (15 x 92 mm), (7,5; 8,2; 8,5 ml)
[48]	*	10 ml Thermo Nalgene® Oak Ridge (16 x 81,5 mm)
[48]	15046	14 ml probówka z pokrywką (16,8 x 113,7 mm), Sarstedt® 14 ml tube with cap (16,8 x 113,7 mm), Sarstedt®
[48]	15053	10 ml probówka z pokrywką (16 x 106 mm) 10 ml tube with cap (16 x 106 mm)
[48]	15118	10 ml probówka szklana (16 x 100 mm) 10 ml glass tube (16 x 100 mm)
<b>14847</b>		
[48]	15050	15 ml probówka z dnem stożkowym z zakrętką (17 x 120 mm), Sarstedt® 15 ml tube, conical bottom, with cap (17 x 120 mm), Sarstedt®
<b>14848</b>		
[20]	*	28 ml Thermo Nalgene® Oak Ridge (25,4 x 101,8 mm)
[20]	15055	30 ml probówka z pokrywką (25,4 x 103,2 mm) 30 ml tube with cap (25,4 x 103,2 mm)
[20]	15056	30 ml Thermo Nalgene® Oak Ridge (25,5 x 94,3 mm) 30 ml Thermo Nalgene® Oak Ridge (25,5 x 94,3 mm)
[20]	15117	25 ml probówka szklana (25 x 100 mm) 25 ml glass tube (25 x 100 mm)
<b>14849</b>		
[16]	*	50 ml probówka z dnem stożkowym z zakrętką (30 x 117 mm), Falcon®; [15052] 50ml (30 x 117mm) 50 ml tube, conical bottom, with cap (30 x 117 mm), Falcon®; [15052] 50ml Sarstedt® (30 x 117 mm)
[16]	*	50 ml probówka z dnem stożkowym bez rantu (30 x 115 mm), Greiner® 50 ml tube, conical bottom, without skirt (30 x 115 mm), Greiner®
<b>14850</b>		
[4]	15115	100 ml probówka szklana (44 x 100 mm) 100 ml glass tube (44 x 100 mm)
[4]	15040	100 ml probówka z pokrywką (45,2 x 103,7 mm) 100 ml tube with cap (45,2 x 103,7 mm)
<b>14853</b>		
[84]	*	2-1,5 ml probówka (10,8x41,8 mm), Eppendorf®; [15011], 2 ml (10,8x41,8 mm); [15128], 1,5ml (10,8x40,5 mm) 2-1,5 ml tube (10,8x41,8 mm), Eppendorf®; [15011], 2 ml (10,8x41,8 mm); [15128], 1,5ml (10,8x40,5 mm)
[84]	*	2 ml probówki z filtrem - spin columns (10,8 x 46 mm) 2 ml spin columns (with filter) (10,8 x 46 mm); [15011], 2 ml (10,8x41,8 mm); [15128], 1,5ml (10,8x40,5 mm)
<b>14854</b>		
[4]	15440	200 ml butelka płaskodenna (56 x 112 mm), Herolab® nr 25 33 73 200 ml bottle, flat bottom (56 x 112 mm), Herolab® no. 25 33 73
<b>14859</b>		
[12]	15116	50 ml probówka szklana (35 x 100 mm) 50 ml glass tube (35 x 100 mm)
<b>14861</b>		
[96]	15016	Sarstedt S-Monovette® (8 x 66 mm), (1,1; 1,2; 1,4 ml) Sarstedt S-Monovette® (8 x 66 mm), (1,1; 1,2; 1,4 ml)
<b>14867</b>		
[36]	*	15 ml probówka z dnem stożkowym z zakrętką (17 x 120 mm), Falcon®; [15050], 15ml (17 x 120 mm) 15 ml tube, conical bottom, with cap (17 x 120 mm), Falcon®; [15050] 15ml Sarstedt®(17 x 120 mm)
<b>14850+14159</b>		
[4]	15116	50 ml probówka szklana (35 x 100 mm) 50 ml glass tube (35 x 100 mm)
<b>14851+14017</b>		
[4]	15129	250 ml butelka okrągłodenna (62 x 122 mm), Herolab® nr 25 34 43 250 ml round-bottom bottle (62 x 122 mm), Herolab® no. 25 34 43
<b>14851+14175</b>		
[4]	15175	250 ml butelka płaskodenna (62 x 122 mm), Herolab® nr 25 34 21 250 ml bottle, flat bottom (62 x 122 mm), Herolab® no. 25 34 21
[4]	15176	250 ml butelka płaskodenna (62 x 122 mm), Herolab® nr 25 34 01 250 ml bottle, flat bottom (62 x 122 mm), Herolab® no. 25 34 01
<b>bez wkładki/without adapter</b>		
[4]	15852	500 ml butelka (84 x 135 mm), Herolab® nr 25 36 11 500 ml bottle (84 x 135 mm), Herolab® no. 25 36 11

**A. Wyposażenie dodatkowe/Optional accessories****MPW-380/R****13865****14043**

- [28] \* Greiner Vacuette® (13 x 75 mm), (1-4,5 ml)  
[28] 15120 5 ml probówka szklana (12 x 75 mm)  
5 ml glass tube (12 x 75 mm)  
[28] 15419 5 ml probówka z korkiem (12 x 85 mm), Sarstedt®  
5 ml tube with cap (12 x 85 mm), Sarstedt®

**14071**

- [28] \* 28 ml Thermo Nalgene® Oak Ridge (25,4 x 101,8 mm)  
[28] 15055 30 ml probówka z pokrywką (25,4 x 103,2 mm)  
30 ml tube with cap (25,4 x 103,2 mm)  
[28] 15056 30 ml Thermo Nalgene® Oak Ridge (25,5 x 94,3 mm)  
30 ml Thermo Nalgene® Oak Ridge (25,5 x 94,3 mm)  
[28] 15117 25 ml probówka szklana (25 x 100 mm)  
25 ml glass tube (25 x 100 mm)  
[28] 15424 30 ml probówka z pokrywką (25,5 x 94 mm), Nalgene®  
30 ml tube with cap (25,5 x 94 mm), Nalgene®

**14073**

- [28] \* BD Vacutainer® (16 x 100 mm), (2,5-11 ml)  
[28] \* Greiner Vacuette® (16 x 100 mm), (7-9 ml)  
[28] \* Sarstedt S-Monovette® (15 x 92 mm), (7,5; 8,2; 8,5 ml)  
[28] \* Sarstedt S-Monovette® (16 x 92 mm), (9; 10 ml)  
[28] 15048 15 ml Thermo Nalgene® (16 x 113 mm)  
15 ml Thermo Nalgene® (16 x 113 mm)  
[28] 15053 10 ml probówka z pokrywką (16 x 106 mm)  
10 ml tube with cap (16 x 106 mm)  
[28] 15118 10 ml probówka szklana (16 x 100 mm)  
10 ml glass tube (16 x 100 mm)  
[28] 15046 14 ml probówka z pokrywką (16,8 x 113,7 mm), Sarstedt®  
14 ml tube with cap (16,8 x 113,7 mm), Sarstedt®

**14089**

- [4] \* 15 ml probówka z dnem stożkowym z zakrętką (17 x 120 mm), Falcon®; [15050], 15ml (17 x 120 mm)  
15 ml tube, conical bottom, with cap (17 x 120 mm), Falcon®; [15050] 15ml Sarstedt® (17 x 120 mm)

**bez wkładki/without adapter**

- [28] \* 50 ml probówka z dnem stożkowym z zakrętką (30 x 117 mm), Falcon®; [15052] 50ml (30 x 117mm)  
50 ml tube, conical bottom, with cap (30 x 117 mm), Falcon®; [15052] 50ml Sarstedt® (30 x 117 mm)  
[28] \* 50 ml probówka z dnem stożkowym bez rantu (30 x 115 mm), Greiner®  
50 ml tube, conical bottom, without skirt (30 x 115 mm), Greiner®

**13866****14043**

- [24] \* Greiner Vacuette® (13 x 75 mm), (1-4,5 ml)  
[24] 15120 5 ml probówka szklana (12 x 75 mm)  
5 ml glass tube (12 x 75 mm)  
[24] 15419 5 ml probówka z korkiem (12 x 85 mm), Sarstedt®  
5 ml tube with cap (12 x 85 mm), Sarstedt®

**14071**

- [24] \* 28 ml Thermo Nalgene® Oak Ridge (25,4 x 101,8 mm)  
[24] 15055 30 ml probówka z pokrywką (25,4 x 103,2 mm)  
30 ml tube with cap (25,4 x 103,2 mm)  
[24] 15056 30 ml Thermo Nalgene® Oak Ridge (25,5 x 94,3 mm)  
30 ml Thermo Nalgene® Oak Ridge (25,5 x 94,3 mm)  
[24] 15117 25 ml probówka szklana (25 x 100 mm)  
25 ml glass tube (25 x 100 mm)  
[24] 15424 30 ml probówka z pokrywką (25,5 x 94 mm), Nalgene®  
30 ml tube with cap (25,5 x 94 mm), Nalgene®

**14073**

- [24] \* BD Vacutainer® (16 x 100 mm), (2,5-11 ml)  
[24] \* Greiner Vacuette® (16 x 100 mm), (7-9 ml)  
[24] \* Sarstedt S-Monovette® (15 x 92 mm), (7,5; 8,2; 8,5 ml)  
[24] \* Sarstedt S-Monovette® (16 x 92 mm), (9; 10 ml)  
[24] 15046 14 ml probówka z pokrywką (16,8 x 113,7 mm), Sarstedt®  
14 ml tube with cap (16,8 x 113,7 mm), Sarstedt®  
[24] 15048 15 ml Thermo Nalgene® (16 x 113 mm)  
15 ml Thermo Nalgene® (16 x 113 mm)  
[24] 15053 10 ml probówka z pokrywką (16 x 106 mm)  
10 ml tube with cap (16 x 106 mm)  
[24] 15118 10 ml probówka szklana (16 x 100 mm)  
10 ml glass tube (16 x 100 mm)

**A. Wyposażenie dodatkowe/Optional accessories****MPW-380/R****14089**

- [4] \* 15 ml probówka z dnem stożkowym z zakrętką (17 x 120 mm), Falcon®; [15050], 15ml (17 x 120 mm)  
15 ml tube, conical bottom, with cap (17 x 120 mm), Falcon®; [15050] 15ml Sarstedt® (17 x 120 mm)

**bez wkładki/without adapter**

- [24] \* 50 ml probówka z dnem stożkowym z zakrętką (30 x 117 mm), Falcon®; [15052] 50ml (30 x 117mm)  
50 ml tube, conical bottom, with cap (30 x 117 mm), Falcon®; [15052] 50ml Sarstedt® (30 x 117 mm)
- [24] \* 50 ml probówka z dnem stożkowym bez rantu (30 x 115 mm), Greiner®  
50 ml tube, conical bottom, without skirt (30 x 115 mm), Greiner®

**13831+17832****14121**

- [28] 15222 30 ml probówka z pokrywką (25 x 94mm), Sterilin®  
30 ml tube with cap (25 x 94 mm), Sterilin®
- [28] 15223 30 ml probówka z pokrywką (25 x 94 mm), Sterilin®  
30 ml tube with cap (25 x 94 mm), Sterilin®

**14837**

- [64] \* BD Vacutainer® (16 x 100 mm), (2,5-11 ml)
- [64] \* Greiner Vacuette® (16 x 100 mm), (7-9 ml)
- [64] \* Sarstedt S-Monovette® (15 x 75 mm), (4; 4,3; 5,5 ml)
- [64] \* Sarstedt S-Monovette® (15 x 92 mm), (7,5; 8,2; 8,5 ml)
- [64] \* Sarstedt S-Monovette® (16 x 92 mm), (9; 10 ml)
- [64] \* 10 ml Thermo Nalgene® Oak Ridge (16 x 81,5 mm)
- [64] 15046 14 ml probówka z pokrywką (16,8 x 113,7 mm), Sarstedt®  
14 ml tube with cap (16,8 x 113,7 mm), Sarstedt®
- [64] 15048 15 ml Thermo Nalgene® (16 x 113 mm)  
15 ml Thermo Nalgene® (16 x 113 mm)
- [64] 15053 10 ml probówka z pokrywką (16 x 106 mm)  
10 ml tube with cap (16 x 106 mm)
- [64] 15118 10 ml probówka szklana (16 x 100 mm)  
10 ml glass tube (16 x 100 mm)

**14838**

- [48] \* 15 ml probówka z dnem stożkowym z zakrętką (17 x 120 mm), Falcon®; [15050], 15ml (17 x 120 mm)  
15 ml tube, conical bottom, with cap (17 x 120 mm), Falcon®; [15050] 15ml Sarstedt® (17 x 120 mm)

**14839**

- [32] \* 28 ml Thermo Nalgene® Oak Ridge (25,4 x 101,8 mm)
- [32] 15055 30 ml probówka z pokrywką (25,4 x 103,2 mm)  
30 ml tube with cap (25,4 x 103,2 mm)
- [32] 15056 30 ml Thermo Nalgene® Oak Ridge (25,5 x 94,3 mm)  
30 ml Thermo Nalgene® Oak Ridge (25,5 x 94,3 mm)
- [32] 15117 25 ml probówka szklana (25 x 100 mm)  
25 ml glass tube (25 x 100 mm)
- [32] 15424 30 ml probówka z pokrywką (25,5 x 94 mm), Nalgene®  
30 ml tube with cap (25,5 x 94 mm), Nalgene®

**14840**

- [20] \* 50 ml probówka z dnem stożkowym z zakrętką (30 x 117 mm), Falcon®; [15052] 50ml (30 x 117mm)  
50 ml tube, conical bottom, with cap (30 x 117 mm), Falcon®; [15052] 50ml Sarstedt® (30 x 117 mm)
- [20] \* 50 ml probówka z dnem stożkowym bez rantu (30 x 115 mm), Greiner®  
50 ml tube, conical bottom, without skirt (30 x 115 mm), Greiner®

**14841**

- [8] 15040 100 ml probówka z pokrywką (45,2 x 103,7 mm)  
100 ml tube with cap (45,2 x 103,7 mm)
- [8] 15115 100 ml probówka szklana (44 x 100 mm)  
100 ml glass tube (44 x 100 mm)

**14844**

- [104] \* 2-1,5 ml probówka (10,8x41,8 mm), Eppendorf®; [15011], 2 ml (10,8x41,8 mm); [15128], 1,5ml (10,8x40,5 mm)  
2-1,5 ml tube (10,8x41,8 mm), Eppendorf®; [15011], 2 ml (10,8x41,8 mm); [15128], 1,5ml (10,8x40,5 mm)
- [104] \* 2 ml probówki z filtrem - spin columns (10,8 x 46 mm)  
2 ml spin columns (with filter) (10,8 x 46 mm); [15011], 2 ml (10,8x41,8 mm); [15128], 1,5ml (10,8x40,5 mm)

**14860**

- [112] 15016 Sarstedt S-Monovette® (8 x 66 mm), (1,1; 1,2; 1,4 ml)  
Sarstedt S-Monovette® (8 x 66 mm), (1,1; 1,2; 1,4 ml)

**14862**

- [100] \* Sarstedt S-Monovette® (11 x 66 mm), (1,6; 2; 2,7; 3; 3,1 ml)
- [100] \* Sarstedt S-Monovette® (11 x 92 mm), (4,5; 5 ml)
- [100] 15054 6 ml probówka z pokrywką (11,5 x 92 mm), Sarstedt®  
6 ml tube with cap (11,5 x 92 mm), Sarstedt®
- [100] 15119 7 ml probówka szklana (12 x 100 mm)  
7 ml glass tube (12 x 100 mm)
- [100] 15120 5 ml probówka szklana (12 x 75 mm)  
5 ml glass tube (12 x 75 mm)

**A. Wyposażenie dodatkowe/Optional accessories****MPW-380/R**

[100] 15419 5 ml probówka z korkiem (12 x 85 mm), Sarstedt®  
5 ml tube with cap (12 x 85 mm), Sarstedt®

**14863**

[96] \* Sarstedt S-Monovette® (11 x 92 mm), (4,5; 5 ml)

[96] \* BD Vacutainer® (13 x 75 mm), (1,6-5,3 ml)

[96] \* BD Vacutainer® (13 x 100 mm), (4-7 ml)

[96] \* Greiner Vacuette® (13 x 75 mm), (1-4,5 ml)

[96] \* Greiner Vacuette® (13 x 100 mm), (3,5-6 ml)

[96] \* Sarstedt S-Monovette® (13 x 75 mm), (2,7; 3; 4,3 ml)

[96] \* Sarstedt S-Monovette® (13 x 65 mm), (2,6; 2,9; 3,4; 3,8 ml)

[96] \* Sarstedt S-Monovette® (13 x 90 mm), (4,9; 5,6 ml)

[96] 15054 6 ml probówka z pokrywką (11,5 x 92 mm), Sarstedt®

6 ml tube with cap (11,5 x 92 mm), Sarstedt®

[96] 15120 5 ml probówka szklana (12 x 75 mm)

5 ml glass tube (12 x 75 mm)

[96] 15419 5 ml probówka z korkiem (12 x 85 mm), Sarstedt®

5 ml tube with cap (12 x 85 mm), Sarstedt®

**14842+14017**

[4] 15129 250 ml butelka okrągłodenna (62 x 122 mm), Herolab® nr 25 34 43

250 ml round-bottom bottle (62 x 122 mm), Herolab® no. 25 34 43

**14842+14175**

[4] 15175 250 ml butelka płaskodenna (62 x 122 mm), Herolab® nr 25 34 21

250 ml bottle, flat bottom (62 x 122 mm), Herolab® no. 25 34 21

[4] 15176 250 ml butelka płaskodenna (62 x 122 mm), Herolab® nr 25 34 01

250 ml bottle, flat bottom (62 x 122 mm), Herolab® no. 25 34 01

**13833+17834****14845**

[72] \* BD Vacutainer® (13 x 75 mm), (1,6-5,3 ml)

[72] \* BD Vacutainer® (13 x 100 mm), (4-7 ml)

[72] \* Greiner Vacuette® (13 x 75 mm), (1-4,5 ml)

[72] \* Greiner Vacuette® (13 x 100 mm), (3,5-6 ml)

[72] \* Sarstedt S-Monovette® (11 x 66 mm), (1,6; 2; 2,7; 3; 3,1 ml)

[72] \* Sarstedt S-Monovette® (13 x 65 mm), (2,6; 2,9; 3,4; 3,8 ml)

[72] \* Sarstedt S-Monovette® (13 x 75 mm), (2,7; 3; 4,3 ml)

[72] \* Sarstedt S-Monovette® (11 x 92 mm), (4,5; 5 ml)

[72] \* Sarstedt S-Monovette® (13 x 90 mm), (4,9; 5,6 ml)

[72] 15054 6 ml probówka z pokrywką (11,5 x 92 mm), Sarstedt®

6 ml tube with cap (11,5 x 92 mm), Sarstedt®

[72] 15120 5 ml probówka szklana (12 x 75 mm)

5 ml glass tube (12 x 75 mm)

[72] 15419 5 ml probówka z korkiem (12 x 85 mm), Sarstedt®

5 ml tube with cap (12 x 85 mm), Sarstedt®

[72] 15119 7 ml probówka szklana (12 x 100 mm)

7 ml glass tube (12 x 100 mm)

**14846**

[48] \* Greiner Vacuette® (16 x 100 mm), (7-9 ml)

[48] \* Sarstedt S-Monovette® (15 x 92 mm), (7,5; 8,2; 8,5 ml)

[48] \* 10 ml Thermo Nalgene® Oak Ridge (16 x 81,5 mm)

[48] 15046 14 ml probówka z pokrywką (16,8 x 113,7 mm), Sarstedt®

14 ml tube with cap (16,8 x 113,7 mm), Sarstedt®

[48] 15053 10 ml probówka z pokrywką (16 x 106 mm)

10 ml tube with cap (16 x 106 mm)

[48] 15118 10 ml probówka szklana (16 x 100 mm)

10 ml glass tube (16 x 100 mm)

**14847**

[48] 15050 15 ml probówka z dnem stożkowym z zakrętką (17 x 120 mm), Sarstedt®

15 ml tube, conical bottom, with cap (17 x 120 mm), Sarstedt®

**14848**

[20] \* 28 ml Thermo Nalgene® Oak Ridge (25,4 x 101,8 mm)

[20] 15055 30 ml probówka z pokrywką (25,4 x 103,2 mm)

30 ml tube with cap (25,4 x 103,2 mm)

[20] 15056 30 ml Thermo Nalgene® Oak Ridge (25,5 x 94,3 mm)

30 ml Thermo Nalgene® Oak Ridge (25,5 x 94,3 mm)

[20] 15117 25 ml probówka szklana (25 x 100 mm)

25 ml glass tube (25 x 100 mm)

**14849**

[16] \* 50 ml probówka z dnem stożkowym z zakrętką (30 x 117 mm), Falcon®; [15052] 50ml (30 x 117mm)

50 ml tube, conical bottom, with cap (30 x 117 mm), Falcon®; [15052] 50ml Sarstedt® (30 x 117 mm)

**A. Wyposażenie dodatkowe/Optional accessories****MPW-380/R**

[16]	*	50 ml probówka z dnem stożkowym bez rantu (30 x 115 mm), Greiner® 50 ml tube, conical bottom, without skirt (30 x 115 mm), Greiner®
<b>14850</b>		
[4]	15115	100 ml probówka szklana (44 x 100 mm) 100 ml glass tube (44 x 100 mm)
[4]	15040	100 ml probówka z pokrywką (45,2 x 103,7 mm) 100 ml tube with cap (45,2 x 103,7 mm)
<b>14853</b>		
[84]	*	2-1,5 ml probówka (10,8x41,8 mm), Eppendorf®; [15011], 2 ml (10,8x41,8 mm); [15128], 1,5ml (10,8x40,5 mm) 2-1,5 ml tube (10,8x41,8 mm), Eppendorf®; [15011], 2 ml (10,8x41,8 mm); [15128], 1,5ml (10,8x40,5 mm)
[84]	*	2 ml probówki z filtrem - spin columns (10,8 x 46 mm) 2 ml spin columns (with filter) (10,8 x 46 mm); [15011], 2 ml (10,8x41,8 mm); [15128], 1,5ml (10,8x40,5 mm)
<b>14854</b>		
[4]	15440	200 ml butelka płaskodenna (56 x 112 mm), Herolab® nr 25 33 73 200 ml bottle, flat bottom (56 x 112 mm), Herolab® no. 25 33 73
<b>14859</b>		
[12]	15116	50 ml probówka szklana (35 x 100 mm) 50 ml glass tube (35 x 100 mm)
<b>14861</b>		
[96]	15016	Sarstedt S-Monovette® (8 x 66 mm), (1,1; 1,2; 1,4 ml) Sarstedt S-Monovette® (8 x 66 mm), (1,1; 1,2; 1,4 ml)
<b>14867</b>		
[36]	*	15 ml probówka z dnem stożkowym z zakrętką (17 x 120 mm), Falcon®; [15050], 15ml (17 x 120 mm) 15 ml tube, conical bottom, with cap (17 x 120 mm), Falcon®; [15050] 15ml Sarstedt®(17 x 120 mm)
<b>14850+14159</b>		
[4]	15116	50 ml probówka szklana (35 x 100 mm) 50 ml glass tube (35 x 100 mm)
<b>14851+14017</b>		
[4]	15129	250 ml butelka okrągłodenna (62 x 122 mm), Herolab® nr 25 34 43 250 ml round-bottom bottle (62 x 122 mm), Herolab® no. 25 34 43
<b>14851+14175</b>		
[4]	15175	250 ml butelka płaskodenna (62 x 122 mm), Herolab® nr 25 34 21 250 ml bottle, flat bottom (62 x 122 mm), Herolab® no. 25 34 21
[4]	15176	250 ml butelka płaskodenna (62 x 122 mm), Herolab® nr 25 34 01 250 ml bottle, flat bottom (62 x 122 mm), Herolab® no. 25 34 01
<b>bez wkładki/without adapter</b>		
[4]	15852	500 ml butelka (84 x 135 mm), Herolab® nr 25 36 11 500 ml bottle (84 x 135 mm), Herolab® no. 25 36 11

**12900****RPM 4100, RCF 3458, Rmax 184,  $\alpha$  90****13929****14901**

[56]	*	15 ml probówka z dnem stożkowym z zakrętką (17 x 120 mm), Falcon®; [15050], 15ml (17 x 120 mm) 15 ml tube, conical bottom, with cap (17 x 120 mm), Falcon®; [15050] 15ml Sarstedt®(17 x 120 mm)
------	---	--

**14902**

[28]	*	50 ml probówka z dnem stożkowym z zakrętką (30 x 117 mm), Falcon®; [15052] 50ml (30 x 117mm) 50 ml tube, conical bottom, with cap (30 x 117 mm), Falcon®; [15052] 50ml Sarstedt® (30 x 117 mm)
------	---	---

[28]	*	50 ml probówka z dnem stożkowym bez rantu (30 x 115 mm), Greiner® 50 ml tube, conical bottom, without skirt (30 x 115 mm), Greiner®
------	---	--

**14903**

[88]	*	BD Vacutainer® (16 x 100 mm), (2,5-11 ml)
[88]	*	Greiner Vacuette® (16 x 100 mm), (7-9 ml)
[88]	*	10 ml Thermo Nalgene® Oak Ridge (16 x 81,5 mm)
[88]	15048	15 ml Thermo Nalgene® (16 x 113 mm) 15 ml Thermo Nalgene® (16 x 113 mm)
[88]	15118	10 ml probówka szklana (16 x 100 mm) 10 ml glass tube (16 x 100 mm)

**14904**

[100]	*	BD Vacutainer® (13 x 75 mm), (1,6-5,3 ml)
[100]	*	BD Vacutainer® (13 x 100 mm), (4-7 ml)
[100]	*	Greiner Vacuette® (13 x 75 mm), (1-4,5 ml)
[100]	*	Greiner Vacuette® (13 x 100 mm), (3,5-6 ml)
[100]	*	Sarstedt S-Monovette® (13 x 65 mm), (2,6; 2,9; 3,4; 3,8 ml)
[100]	*	Sarstedt S-Monovette® (13 x 75 mm), (2,7; 3; 4,3 ml)
[100]	*	Sarstedt S-Monovette® (13 x 90 mm), (4,9; 5,6 ml)

**A. Wyposażenie dodatkowe/Optional accessories****MPW-380/R**

[100]	15119	7 ml probówka szklana (12 x 100 mm) 7 ml glass tube (12 x 100 mm)
[100]	15120	5 ml probówka szklana (12 x 75 mm) 5 ml glass tube (12 x 75 mm)
<b>bez wkładki/without adapter</b>		
[4]	15929	750ml butelka (100x130mm), Herolab® nr 25 37 35 750 ml bottle (100 x 130 mm), Herolab® no. 25 37 35

**12926****RPM 5700, RCF 5085, Rmax 140,  $\phi$  90****13927****bez wkładki/without adapter**

[4]	*	płytki titracyjna DWP 96/2000 $\mu$ l (127,8x85,5x44,1 mm) deepwell plate DWP 96/2000 $\mu$ l (127,8 x 85,5 x 44,1 mm)
[10]	15102	płytki titracyjna MTP 28,8ml (86x128x15/17,5 mm) microtiter plate MTP 28,8 ml (86 x 128 x 15/17,5 mm)

**Suma końcowa**

## DECLARATION OF CONFORMITY

Product name: **Laboratory centrifuge  
MPW-380**

Product type: **Laboratory centrifuge**

This declaration of conformity is issued under the sole responsibility of the manufacturer.

Product classification on the basis of the Directive 98/79/EC: **Non classified to list A or B and not for self-testing.**

**Product complies with the requirements:**

**• Directive 98/79/EC (IVD), including the requirements of harmonized standards:**

EN 15223-1:2016

EN ISO 18113-3:2011

EN 13612:2002

EN 61326-2-6:2006

EN 13612:2002/AC:2002

EN 61010-2-101:2002

EN 13975:2003

EN 62304:2006

EN ISO 14971:2012

EN 62304:2006/AC:2008

EN ISO 18113-1:2011

EN 62366:2008

**• selected harmonized standards of Directive 2014/35/UE (LVD):**

EN 61010-1:2010

EN 61010-2-020:2006

EN 61010-1:2010/A1:2019

EN 61010-1:2010/A1:2019/AC:2019-04

**• Directive 2014/30/UE (EMC)**

**• Directive 2011/65/UE (RoHS 2)**

Z-ca PREZESA ZARZĄDU

Wojciech Anisiewicz

PREZES ZARZĄDU  
mgr Łukasz Sałanski

**"MPW MED. INSTRUMENTS"**

**SPÓŁDZIELNIA PRACY**

Warsaw, 46 Boremlowska Street

applies Quality Management System in line with

PN-EN ISO 9001:2015, PN-EN ISO 13485:2016



ISO 9001



ISO 13485



## DECLARATION OF CONFORMITY

Product name: **Refrigerated laboratory centrifuge  
MPW-380R**

Product type: **Laboratory centrifuge**

This declaration of conformity is issued under the sole responsibility of the manufacturer.

Product classification on the basis of the Directive 98/79/EC: **Non classified to list A or B and not for self-testing.**

**Product complies with the requirements:**

**• Directive 98/79/EC (IVD), including the requirements of harmonized standards:**

EN 15223-1:2016

EN ISO 18113-3:2011

EN 13612:2002

EN 61326-2-6:2006

EN 13612:2002/AC:2002

EN 61010-2-101:2002

EN 13975:2003

EN 62304:2006

EN ISO 14971:2012

EN 62304:2006/AC:2008

EN ISO 18113-1:2011

EN 62366:2008

**• selected harmonized standards of Directive 2014/35/UE (LVD):**

EN 61010-1:2010

EN 61010-2-020:2006

EN 61010-1:2010/A1:2019

EN 61010-1:2010/A1:2019/AC:2019-04

**• Directive 2014/30/UE (EMC)**

**• Directive 2011/65/UE (RoHS 2).**

Z-ca PREZESA ZARZĄDU

Wojciech Anisiewicz

PREZES ZARZĄDU

mgr Łukasz Satański

**"MPW MED. INSTRUMENTS"**  
**SPÓŁDZIELNIA PRACY**  
Warsaw, 46 Boremlowska Street  
*applies Quality Management System in line with  
PN-EN ISO 9001:2015, PN-EN ISO 13485:2016*



# DECLARATION OF DECONTAMINATION

(repair)

In order to protect our employees please fill out the declaration of decontamination completely before sending centrifuge to the manufacturer (repair).

**1. Device:**

– type: .....

– serial No.: .....

**2. Description of decontamination**

(see user manual)

.....  
.....  
.....  
.....

**3. Decontamination carried out by:**

name: .....

**4. Date and signature:**

.....

# DECLARATION OF DECONTAMINATION

(return)

In order to protect our employees please fill out the declaration of decontamination completely before sending centrifuge to the manufacturer (return).

**1. Device:**

– type: .....

– serial No.: .....

**2. Description of decontamination**

(see user manual)

.....

.....

.....

.....

**3. Decontamination carried out by:**

name: .....

**4. Date and signature:**

.....

# NOMOGRAM

Centrifuging radius [cm]

R.C.F. (x "g")  
multiple of  
gravitational  
acceleration

[r.p.m.]

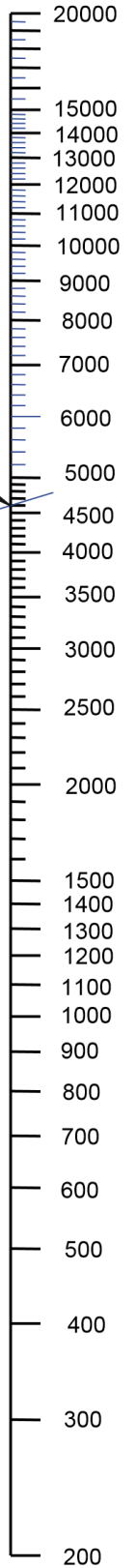
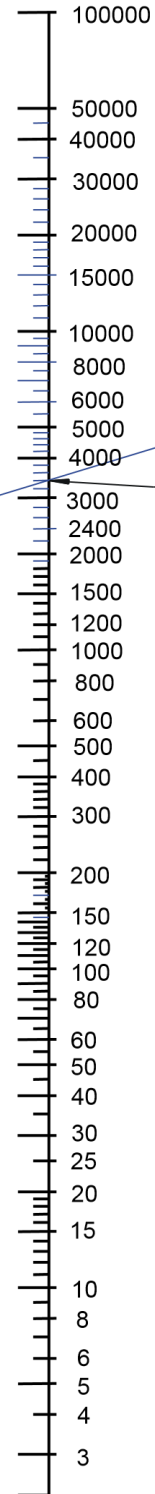
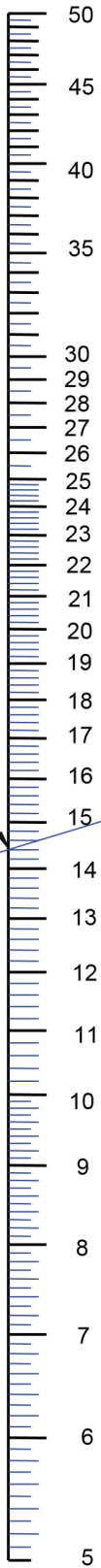

Formula used for calculation of this nomogram :

$$R.C.F. = 11,18 * r * (n/1000)^2$$

where :

- R.C.F. - multiple of gravitational acceleration
- r - centrifuging radius (cm)
- n - rotational speed (r.p.m.)
- g - gravitational acceleration

A

B

C

Example of making use  
of the nomogram:

A=14,4 cm  
B=4600 r.p.m.  
C=3400 x g

$$n = 1000 * \sqrt{\frac{RCF}{(11,18 * r)}}$$

$$r = \frac{RCF}{\left[ 11,18 * \left( \frac{n}{1000} \right)^2 \right]}$$