

USER MANUAL



LABORATORY CENTRIFUGE MPW-54

Read before use!

Serial number of the centrifuge:

For centrifuges with serial no (SN): from 1005423622



This manual was prepared with special care. MPW MED. INSTRUMENTS may change the manual at any time and without notice because of improvements, typographical errors, or improvements to facilities

All rights reserved. No part of this User Manual may be modified, distributed, published, or reproduced without the prior permission of MPW MED. INSTRUMENTS.









You can find the current version of the user manual on our website under:

www.mpw.pl DOWNLOAD section (one should choose demanded language version of website).

Content

1. Symbols used in the manual and on the device	4
2. Application	4
3. Technical specification	5
3.1. Environmental conditions	5
4. Installation	6
4.1. Unpacking.....	6
4.2. The contents of the package	6
4.3. Consumable Materials	6
4.4. Location.....	6
4.5. Current protection	7
5. Safety notes	7
5.1. General remarks.....	7
5.2. Placing the rotor and accessories in the centrifuge	7
5.3. Filling tubes	8
5.4. Filling the rotor.....	8
5.5. Safety hints.....	9
5.6. Operating conditions.....	10
5.7. Equipment life	10
5.8. Work safety	10
5.9. Residual risk	11
6. Operating	12
6.1. Centrifuge overview	12
6.2. Centrifuge description.....	12
6.3. Name plate.....	13
6.4. Control device	13
6.5. Set up parameters.....	13
6.6. Safety features	13
6.7. Increase in temperature.....	13
7. Centrifuging.....	14
7.1. Control panel.....	14
7.2. HOLD mode	14
7.3. End of the centrifuging.....	14
7.4. Signaling states of centrifuge	15
8. Maintenance	16
8.1. Cleaning of the centrifuge	16
8.2. Maintenance of centrifuge elements.....	16
8.3. Sterilization	17
8.4. Autoclaving.....	18
8.5. Chemical resistance.....	19
9. Troubleshooting	20
9.1. Emergency cover release	20
10. Guarantee	21
11. Transport and storage	21
11.1. Transport and storage conditions	21
11.1. Disposal	21
12. Manufacturer's info.....	22
Distributor's info.....	22
13. Annexes.....	22
A. Additional accessories	
B. Declaration of conformity (CE, ROHS 2)	
C. Declaration of decontamination (repair / return)	
D. Nomogram RPM / RCF	

1. Symbols used in the manual and on the device

Symbol	Explanation
	WARNING! Warning of potential injury or health risk
	DANGER! Risk of electric shock with potential for severe injury or death as a consequence
	DANGER! Biohazard with potential for risk to health or death as a consequence
	DANGER! Risk of explosion with potential for severe injury or death as a consequence
	Symbol identifying a medical device for in vitro diagnostic use
	CE mark
	Symbol informing about the method of disposal
	Please read the instruction manual before you start working with the device
	Manufacturer's data

The terms "**accessories**", "**optional accessories**" and "**equipment**" used in this manual mean the components of the centrifuge, such as: rotors, containers and reducing inserts

2. Application

- The **MPW-54** centrifuge is a bench-top non-automatic laboratory centrifuge.
- The device is intended for In Vitro Diagnostics (IVD). This means that it is an in vitro diagnostic medical device - in accordance with the Regulation of the European Parliament and of the Council (EU) of 5 April 2017 on in vitro diagnostic medical devices and repealing Directive 98/79/EC and Commission Decision 2010 /227/EU.
- The centrifuge is used to separate aqueous solutions and suspensions of samples with a density not higher than 1.2g/cm³ taken from human, animal and plant organisms into components of different densities under the influence of centrifugal force, in order to provide information about their biological state and to other analytical work.

- The design of the centrifuge ensures ease of use, safe operation and a wide range of applications in medical, biochemical and other analysis laboratories.
- The centrifuge is not biotight, therefore, when centrifuging preparations that require biotightness, containers and rotors with a biotightness certificate should be used.

3. Technical specification

manufacturer	"MPW MED. INSTRUMENTS" SPÓŁDZIELNIA PRACY, Boremlowska 46 Street, 04-347 Warsaw									
type	MPW - 54					MPW – 54s				
cat. no (REF)	10054/2-56	10054/1-56				10054/2-56/S	10054/1-56/S			
mains voltage (L1+N+PE)	230V	100V	110V	120V	127V	230V	100V	110V	120V	127V
	±10%	±5%				±10%	±5%			
frequency	50/60Hz									
connected load (max)	65W									
overcurrent protection	fuse WTA-T 2A 250V									
capacity (max)	120ml									
speed – RPM	(L) 3500, (H) 5800					(L) 1000, (H) 3500*				
force – RCF	1137, 3122					93, 1137				
running time	01:00 ÷ 30:00 [min., s] (step 1min.)									
short-time operation mode – SHORT	no									
continuous operation mode – HOLD	yes									
electromagnetic compatibility	according to EN 61326-2-6:2006									
height (H)	180 mm									
width (W)	220 mm									
depth (D)	270 mm									
height with open lid(H _{oc})	367 mm									
noise level	≤ 56 dB									
weight of centrifuge 230V	approx. 4,2 kg									
weight of centrifuge 120V	approx. 4,2 kg									

*- It is possible to change the speed **H** and **L** in the range from 500 to 5800 RPM

3.1. Environmental conditions

- The device may only be used indoors.
- The permissible ambient temperature is 2°C to 40°C.
- Maximum allowed relative humidity 80% at temperature up to 31°C decreasing linearly to 50% relative humidity at 40°C.
- The mains voltage fluctuations must not exceed ± 10% of the nominal voltage.
- Maximum altitude 2,000 m above sea level.
- Overvoltage category II.
- Pollution degree 2.

4. Installation

4.1. Unpacking

Open the package. Remove the box containing the accessories. Take out centrifuge from the container. Keep the box and packing materials in case of service shipping



4.2. The contents of the package

Name	Quantity (pcs)	Cat No.
Centrifuge MPW-54	1	10054/1-56 ; 10054/2-56 or 10054/1-56/S ; 10054/2-56/S
Rotor fixing screw	1	17168
Rotor key	1	17099T
Key for emergency cover release	1	17162
Power cord 230V/120V	1	17866/17867
Fuse WTA T2A 250V	2	17859
Petroleum jelly 20ml	1	17201
User manual	1	See page 1

4.3. Consumable Materials

	<p>Only original MPW buckets can be used! One should use tubes which dimensions, and durability is proper! Using of tubes from other companies should be consulted with manufacturer of centrifuge. In the centrifuge, disinfectants and cleaning agents generally used in medical care should be used (e.g., Aerodesina-2000, Lysoformin 3000, Melseptol, Melsept SF, Sanepidex, Cutasept F).</p>
--	--

4.4. Location

	<ul style="list-style-type: none"> ▪ The device should be lifted from below near its feet and placed directly on a suitable laboratory table. ▪ The centrifuge should be set so that access to the power switch is not difficult. ▪ Do not place the centrifuge near heaters and avoid direct sunlight. ▪ The table on which the centrifuge is placed should be stable and have a flat, leveled top. ▪ A protection zone of at least 30 cm on all sides should be provided around the centrifuge. The ambient temperature for normal operating conditions of the centrifuge is given in section Environmental conditions. ▪ When changing the place from cold to warm, water condensation inside the centrifuge will occur. It is important to allow sufficient time for drying before restarting the centrifuge (minimum 4 hours). ▪ The supply voltage must match the voltage specified on the rating plate. Laboratory centrifuges by "MPW MED. INSTRUMENTS" are devices with a basic safety class and have a three-wire connection cord with a plug resistant to dynamic loads. ▪ The power socket should have a protective pin. ▪ It is recommended to install an emergency switch located far from the centrifuge near the exit from the room or outside the room.
	<ul style="list-style-type: none"> ▪ Before switching on, check if the centrifuge is properly connected to the power supply. ▪ Only the power cord recommended by the manufacturer may be used.

4.5. Current protection



The centrifuge is equipped with thermal current protection. Fuse is situated in the plug-in socket unit at back wall of the centrifuge.

5. Safety notes

5.1. General remarks



- The laboratory centrifuge may be operated only by qualified laboratory personnel, after reading the operating manual.
- The operating instructions are part of the product.
- The operating manual should always be kept in the vicinity of the centrifuge.
- The centrifuge cannot be operated contrary to its purpose.
- If the centrifuge is used in a manner inconsistent with the manufacturer's guidelines, the safety of its use may be impaired.
- For centrifugation in the centrifuge, only containers and inserts provided in the list of equipment and centrifuge tubes, the diameter, length and strength of which are appropriate, should be used. The use of test tubes not included in the list should be agreed with MPW MED. INSTRUMENTS or its authorized representatives.
- Pay attention to the quality and appropriate thickness of the glass test tubes walls. Glass tubes should be centrifuge tubes, and their use in the centrifuge should be made dependent on the following guidelines:

glass tubes	max RCF in angular rotors
5-10 ml	3000 x g
30-100 ml	spinning not allowed

- Weighing the filled test tubes into the rotor is recommended. This will allow to minimize the differences in mass between them, and as a result to avoid the negative impact of vibrations on the engine suspension and to reduce noise levels during the operation of the centrifuge.

5.2. Placing the rotor and accessories in the centrifuge



- Connect the centrifuge to the power supply (mains socket at the back of the centrifuge).
- Turn on the centrifuge (switch on the side of the centrifuge).
- Open the cover of the centrifuge by pressing the COVER key. Before installing the rotor, check that the rotating chamber is free from any contamination. If there is dust, glass splinters, liquid residues, etc., remove them.
- The rotor can fall if not handled properly, therefore it should always be handled and placed in the centrifuge using both hands.
- Place the rotor on the motor axis by sliding it onto the cone as far as it will go (keeping the coaxiality between the rotor and the motor axis).
- Screw the screw fixing the rotor into the motor axis (clockwise), and then tighten it firmly with the rotor key.
- Fill the rotor with containers / hangers / test tubes according to recommendations in section **Filling the rotor**.
- In order to replace the rotor, first remove the tubes and containers from it, unscrew the screw fixing the rotor with the enclosed rotor key, counterclockwise, then using both hands, grab the rotor on opposite sides and remove it from the motor axis.

- Install another rotor as described above instructions.

5.3. Filling tubes

- Fill test tubes outside the centrifuge.

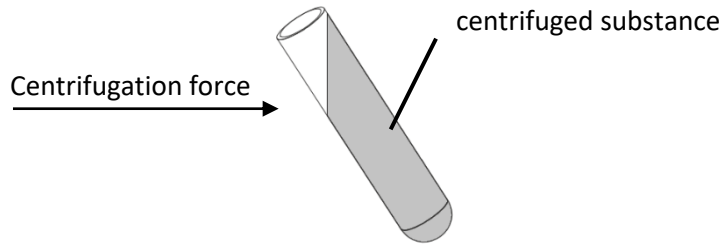

- If the manufacturer of the test tube has not specified the maximum level, fill the test tubes so that the centrifuged substance does not run out of the vessel during centrifugation. To do this, use the formula below:

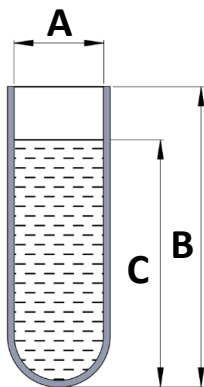

$$C < B - \frac{A}{2}$$

- A – internal tube diameter
- B – tube height
- C – max liquid level

5.4. Filling the rotor



CAUTION!

- Angle rotors must be used with a suitable cover which must be screwed securely onto the rotor. The rotor and the cover are marked with the same catalog number (REF) to eliminate the risk of incorrect selection when you have several types of rotors.



- Check that the impeller is seated correctly and firmly bolted to the motor shaft.
- Do not exceed the maximum rotor load (information is provided on the rotor).

An example of the marking on the angular rotor:

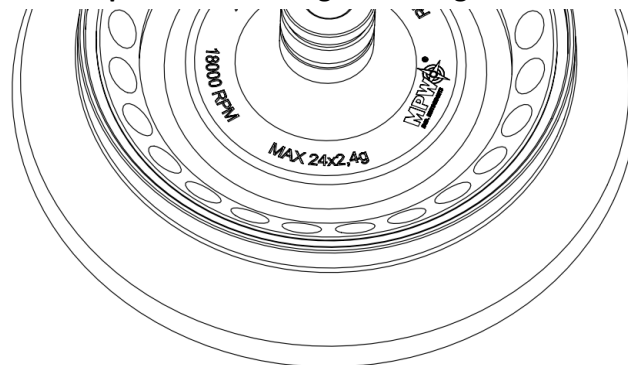

MAX. 24x2,4g - means the possibility of placing 24 test tubes in the rotor, each weighing 2.4 g.



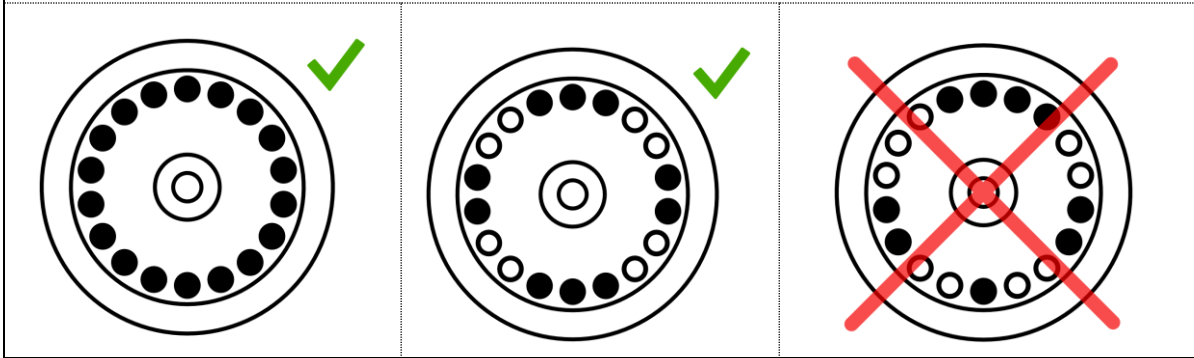

- To ensure symmetrical loading, insert test tubes of the same type and weight in pairs into opposite openings of the rotor. If reduction inserts are used, they should

also be placed in the holes opposite to each other in pairs of the same type.

Examples of correct and incorrect arrangement of test tubes in the rotor:





5.5. Safety hints

	<p>ROTOR MAINTENANCE</p> <ul style="list-style-type: none"> ▪ In order to increase the durability of gaskets, threaded places, rotor pins, undercuts for pins in containers, they must be cleaned, and then it is necessary to lubricate them with the technical petroleum jelly supplied with the device (catalog number 17201). ▪ Use only accessories that are in good technical condition.
	<p>HU EQUIPMENT MAINTENANCE</p> <ul style="list-style-type: none"> ▪ Make sure the sealing rings (rubber) are lightly coated with grease to maintain tightness. Use high vacuum silicone grease, eg type "C" by LUBRINA.
	<p>HAZARDOUS MATERIALS</p> <ul style="list-style-type: none"> ▪ Infectious materials should be centrifuged only in containers / rotors with covers. ▪ It is not allowed to centrifuge toxic or infectious materials if the rotor or test tube seal is damaged. ▪ Appropriate disinfection procedures should always be carried out, if hazardous substances have contaminated the centrifuge or its accessories.
	<p>EXPLOSIVE, FLAMMABLE MATERIALS</p> <ul style="list-style-type: none"> ▪ It is not allowed to centrifuge explosive and inflammable materials. ▪ Do not centrifuge substances that could create a potentially explosive atmosphere as a result of the high energy supply during centrifugation. ▪ The centrifuge must not be used in an explosive atmosphere. ▪ It is not allowed to centrifuge materials that may generate flammable or explosive mixtures when exposed to air.

5.6. Operating conditions

	<p>GENERAL REMARKS</p> <ul style="list-style-type: none">▪ Only original equipment of centrifuges and spare parts should be used.▪ In case of a malfunction of the centrifuge, the MPW MED factory service should be used. INSTRUMENTS or its authorized representatives.▪ It is not allowed to start the centrifuge if it is not installed correctly or the rotor and accessories are not properly mounted.▪ The centrifuge must not be transported with the rotor installed on the motor shaft.▪ Fill the rotor equipment to the same weight in order to prevent unbalance of the centrifuge (point Filling the rotor).
---	---

	<p>START-UP</p> <ul style="list-style-type: none">▪ Before switching on the device, carefully read all sections of this manual in order to ensure the correct operation of the device and to avoid damage to the device or its accessories.
---	--

	<p>CENTRIFUGAL SUBSTANCES</p> <ul style="list-style-type: none">▪ Rotors are designed for centrifuging liquids with an average density of 1.2 g / cm³ or less. This applies to centrifugation at maximum speed. If liquids with a higher density are to be used, be sure to enter the density value in the PARAM / DENSITY tab in order to reduce the available spin speed.
--	--

5.7. Equipment life



	<ul style="list-style-type: none">▪ Each spin cycle in which the rotor has accelerated and decelerated is considered a duty cycle, independent of speed and duration.▪ Do not use the equipment after the allowable after the maximum service life - 5 years.
---	---

5.8. Work safety

The centrifuge should be inspected by an authorized service at least once a year (after the warranty period). Special circumstances, e.g., corrosive environment, may be the reason for more frequent checks. Tests should end with issuing a validation protocol, which specifies checking the technical condition of a laboratory centrifuge.

It is recommended to create a document that records all repairs and inspections. This document should be kept in the place where the centrifuge is used.

	<p>CONTROLS CONDUCTED BY THE OPERATOR</p> <ul style="list-style-type: none">▪ The operator must pay attention to the fact that the parts of the centrifuge, important from the safety point of view, are not damaged. This remark applies to:
---	--

	<ul style="list-style-type: none"> ▪ Centrifuge accessories, especially structural changes, corrosion, initial cracks, abrasion of metal parts. ▪ Bolted connections. ▪ Inspection of rotor and container seals, if any. Particular attention should be paid to rubber elements (seals). In the event of any damage or visible structural changes, they should be immediately replaced with new ones. ▪ Control of the performance of annual post-warranty inspections of the technical condition of the centrifuge.
	<ul style="list-style-type: none"> ▪ During centrifugation, it is not allowed to lift, shift the centrifuge or rest on it. ▪ During centrifugation one must not stay in the safety zone, i.e., 30 cm distance around the centrifuge, nor leave any objects, e.g., glass vessels, inside this zone. ▪ It is not allowed to put any objects on the centrifuge.
	<p>OPENING THE COVER DURING SPINNING</p> <ul style="list-style-type: none"> ▪ It is not allowed to use the emergency cover opening during centrifuging, because it may result in loss of health or life.
	<p>HANDLING OF ROTORS</p> <ul style="list-style-type: none"> ▪ It is not allowed to use accessories (rotors, lids, containers, hangers and round carriers) with signs of corrosion or other mechanical damage. ▪ It is not allowed to centrifuge substances of high corrosive aggressiveness, which may damage the materials and reduce the mechanical properties of rotors, buckets and round carriers. ▪ It is not allowed to centrifuge rotors with removed or loose covers.

5.9. Residual risk

The centrifuge is built according to the state-of-the-art and the recognized safety regulations. Nevertheless, still remain some level of residual risk due to improper operation and malfunctions. It is possible to decrease residual risk by strictly applying user manual conditions and correcting malfunction which could threaten safety, immediately.

6. Operating

6.1. Centrifuge overview

The new generation of laboratory centrifuges "MPW MED. INSTRUMENTS" is equipped with modern microprocessor controllers, very durable and quiet brushless asynchronous motors and equipment that meets modern user requirements. The centrifuge has a rigid self-supporting structure. The housing is made of ABS plastic. The cover is mounted on metal hinge axes, and from the front it is closed with an electromagnetic lock blocking the possibility of opening during spinning. The centrifugation chamber is made of plastic.

6.2. Centrifuge description

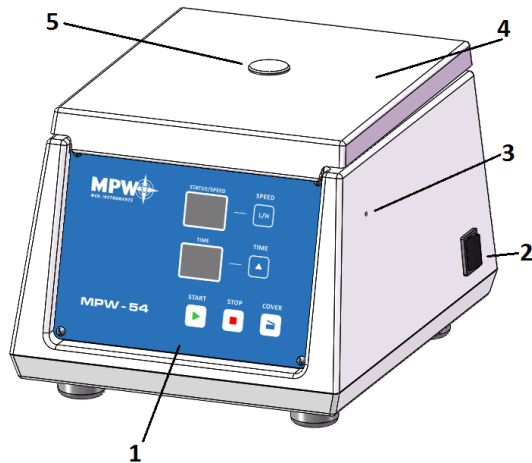

1. Control panel
2. Power switch
3. Place for emergency lid opening
4. Cover
5. Glass inspection

Fig.1. General view

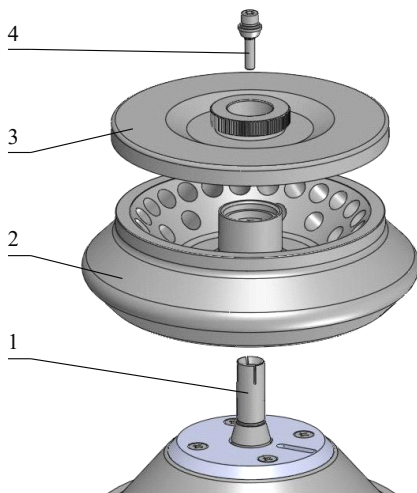

1. Motor axle
2. Rotor
3. Rotor lid
4. Rotor fixing screw

Fig. 2. Angle rotor assembly

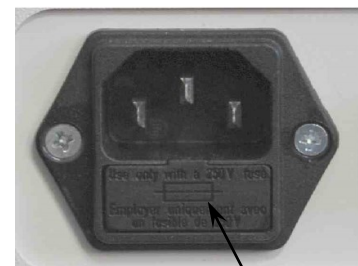

1. Mains socket
2. Fuse socket

Fig. 3. Back of the centrifuge

6.3. Name plate

The data concerning the device should be read from the rating plate located on the rear wall of the centrifuge (the picture below is an example).

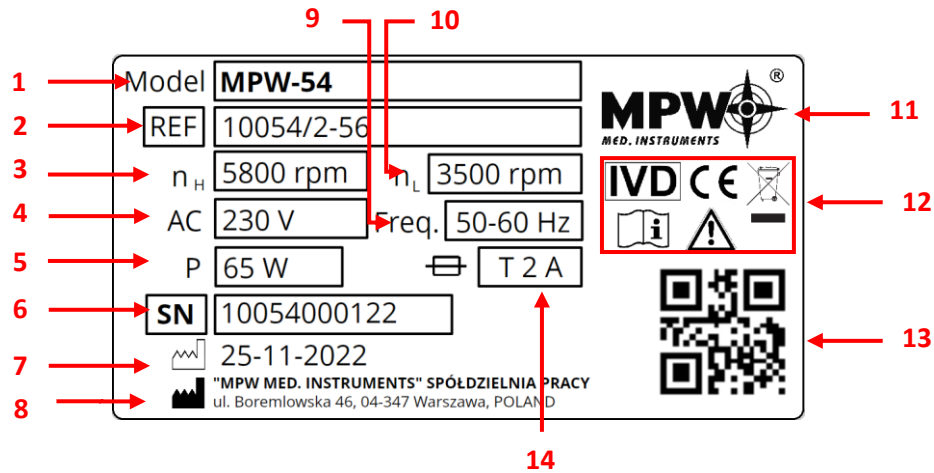

- | | | | |
|---|----------------------------|----|---|
| 1 | Centrifuge model | 9 | Rated frequency |
| 2 | Catalog number | 10 | Minimum speed |
| 3 | Maximum speed | 11 | Manufacturer's logo |
| 4 | Rated voltage | 12 | Approval marks and symbols (explained in chapter 1) |
| 5 | Maximum rated power | 13 | QR code for serial number |
| 6 | Serial number | 14 | Current protection |
| 7 | Date of production | | |
| 8 | Manufacturer's information | | |

6.4. Control device

The microprocessor control unit of the centrifuge ensures broad possibilities of providing, realisation and reading of work parameters.

6.5. Set up parameters

Data setting and read-out system forms hermetically closed keyboard with distinctly accessible operation points. Easily readable display signalling time to end of centrifuging and set mode of speed. It makes easy for the operator to the registration status of the device.

Control system provides possibility of:

- set up speed mode (H) 5800 or (L) 3500 rpm (MPW-54), (H) 3500 or (L) 1000 rpm (MPW-54s),
- set up time of centrifuging in the range 1÷30 min or hold time mode.

6.6. Safety features

Cover lock

The centrifuge can be started only with properly closed cover. While the cover can be opened only after stopping the rotor. In case of emergency opening of the cover during operation, the centrifuge will be immediately switched-off and the rotor will brake till complete stopping.

Rest state inspection

Opening of the centrifuge's cover is possible only with the rotor in the state of rest.

6.7. Increase in temperature

In uncooled centrifuges, the temperature in the rotor chamber, rotor and sample can increase to above 40°C, based on the run time, g-force (rcf)/speed and ambient temperature.

7. Centrifuging

Power switching ON/OFF is carried out with master switch situated on the side wall of the centrifuge. All settings on the centrifuge are done by means of the control panel.

7.1. Control panel

The control panel (equipped with membrane keyboard) placed on the front casing serves the purpose of controlling centrifuge operation. STATUS/SPEED display show information about state of centrifuge (left side) and speed mode (right side). TIME display show information about time remain to the end of centrifuging.

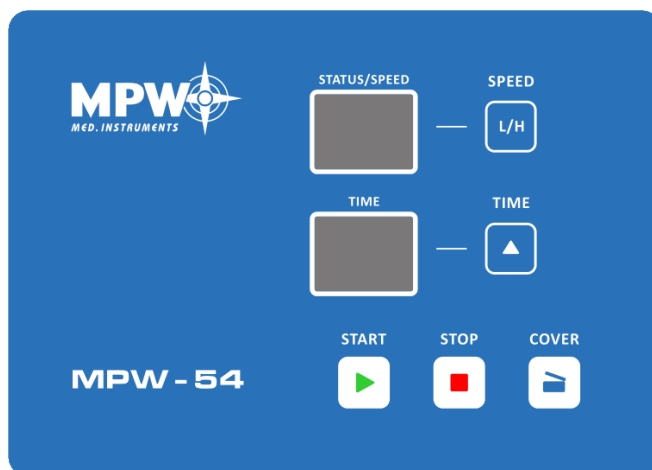

Fig.4 Control panel

Buttons application:

	START	Start of centrifuging
	STOP	Cancel of centrifuging
	COVER	Open the lid
	TIME	Set up runtime (in 1 minute step)
L/H	SPEED	Change speed mode







7.2. HOLD mode

HOLD mode	continuous mode (centrifuging until pressing STOP)
	<ul style="list-style-type: none"> In order to run the HOLD mode, set the time value to - -

7.3. End of the centrifuging

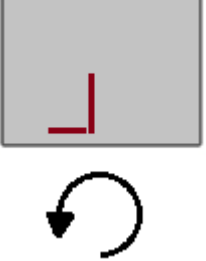
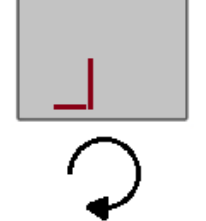
	WAYS OF FINISH THE CENTRIFUGING
	<ul style="list-style-type: none"> After reaching the preset working time centrifuging is stopped.
 x1	<ul style="list-style-type: none"> Before the expiry of the set time, you can interrupt the cycle by pressing the STOP

7.4. Signaling states of centrifuge

<p>STATUS/SPEED</p> 	<ul style="list-style-type: none"> ▪ Cover is locked
<p>STATUS/SPEED</p> 	<ul style="list-style-type: none"> ▪ Cover is open
<p>STATUS/SPEED</p> 	<ul style="list-style-type: none"> ▪ Rotor is running (speed is increasing or constant) – mark turn counter-clockwise
<p>STATUS/SPEED</p> 	<ul style="list-style-type: none"> ▪ Rotor is running (braking) – mark turn clockwise
<p>TIME</p> 	<ul style="list-style-type: none"> ▪ Rotor is running, time is counting – dot next to time indication is blinking
<p>TIME</p> 	<ul style="list-style-type: none"> ▪ Cycle cancelled or end of centrifuging – a dot next to the time indication stops flashing, after braking the rotor, four short beeps are issued
<p>STATUS/SPEED</p> 	<ul style="list-style-type: none"> ▪ Centrifuging in high rotational speed

	<ul style="list-style-type: none"> Centrifuging in low rotational speed
---	--

Centrifuge has memory for remembering the last settings even after turning off and turn on the centrifuge.

8. Maintenance

8.1. Cleaning of the centrifuge

	<ul style="list-style-type: none"> Pull the mains plug before cleaning. Before any cleaning or decontamination process other than that is recommended by the manufacturer, the user has to ask the manufacturer if the planned process does not damage the device For cleaning, water with soap or other water-soluble mild detergent shall be used. One should avoid corrosive and aggressive substances. It is prohibited to use alkaline solutions, inflammable solvents or agents containing abrasive particles. Do not lubricate the centrifuge motor shaft. The unused centrifuge should have cover opened. <p style="text-align: center;">Once a week</p> <p>Using wiping cloth, remove condensate or residues of the products from the rotor chamber.</p> <p style="text-align: center;">Once a month</p> <ul style="list-style-type: none"> Check the condition of the rotor mounting screw thread. If damaged, it must be replaced. Check the centrifuging chamber whether it is damaged. In case of damage, it cannot be longer put into operation. Notify authorized service workshop.
--	--

8.2. Maintenance of centrifuge elements

	<ul style="list-style-type: none"> In order to increase the durability of threaded places, they should be lubricated with technical petroleum jelly. Make sure that the sealing rings (rubber) are covered with a thin layer of technical petroleum jelly in order to maintain tightness (catalog number 17201 - element of basic equipment).
---	---

Cleaning of the equipment

	<ul style="list-style-type: none"> In order to ensure safe operation, one shall carry out in regular way periodical maintenance of the accessories. Rotors, buckets, and round carriers have to withstand high stresses originating from the centrifugal force. Chemical reactions as well as corrosion (combination of variable pressure and chemical reactions) can cause destruction of metals. Hard to observe surface cracks increase gradually and weaken material without visible symptoms. In case of observation of surface damage, crevice, or other change, as well as the corrosion, the given part (rotor, bucket, etc.) shall be immediately replaced.
---	--

	<ul style="list-style-type: none"> ▪ The rotor, including the fixing screw, buckets and round carriers must be regularly cleaned to prevent corrosion. ▪ Cleaning of the accessories shall be carried out outside of the centrifuge once every week or still better after each use. For cleaning them one should use neutral agent of pH value 6÷8. It is forbidden to use alkaline agent of pH > 8. Then, those parts shall be dried using soft fabric or in the chamber drier at ca. 50°C. ▪ Angle rotor should be placed on a fabric with holes facing down, for effective drying. ▪ Do not use bleach on plastic parts of the rotor. ▪ In this way, the useful service life of the device is substantially increased and susceptibility to corrosion is diminished. Accurate maintenance increases the service life as well and protects against premature rotor failures. ▪ Do not use bleach on plastic parts of the rotor. ▪ According to laboratory standards, minimize the immersion time in each solution. ▪ Especially prone to the corrosion are parts made of aluminium. ▪ Corrosion and damages resulting from insufficient maintenance could not be subject of claims lodged against the manufacturer. ▪ The unused rotor should have the lid removed.
--	--

HS accessories maintenance (HU):

	<ul style="list-style-type: none"> ▪ Check the general condition of seals. ▪ Make sure that rubber O-rings are lightly coated with silicone grease. Use high vacuum grease, e.g., type „C” by LUBRINA. ▪ In order to maintain hermetic sealing, it is recommended to replace the sealing rings after each autoclaving. ▪ Store hermetically sealed rotors and buckets with the lids removed.
--	--

8.3. Sterilization

Plastics - legend to abbreviations

PS	polystyrene	ECTFE	ethylene/chlorotrifluoroethylene
SAN	styrene-acrylonitrile	ETFE	ethylene/tetrafluoroethylene
PMMA	polymethyl methacrylate	PTFE	polytetrafluoroethylene
PC	polycarbonate	FEP	tetrafluoroethylene/perfluoropropylene
PVC	polyvinyl chloride	PFA	tetrafluoroethylene/perfluoroalkylvinylether
POM	acetal polyoxymethylenel	FKM	fluorcarbon rubber
PE-LD	low density polyethylene	EPDM	ethylene propylene diene
PE-HD	high density polyethylene	NR	natural rubber
PP	polypropylene	SI	silicon rubber
PMP	polymethylpentene		

One can use all standard disinfectants. Centrifuges and devices are made of different materials, one should consider their variety.

	radiation β radiation γ 25 kGy	C ₂ H ₄ O (ethylene oxide)	formalin, ethanol
PS	●	○	●
SAN	○	●	●
PMMA	●	○	●
PC	●	●	●
PVC	○	●	●
POM	●	●	●
PE-LD	●	●	●
PE-HD	●	●	●

PP	●	●	●
PMP	●	●	●
ECTFE, ETFE	○	●	●
PTFE	○	●	●
FEP, PFA	○	●	●
FKM	○	●	●
EPDM	○	●	●
NR	○	●	●
SI	○	●	●
●	may be used		
○	cannot be used		

In the centrifuge, disinfectants and cleaning agents generally used in medical care should be used (e.g., Aerodesina-2000, Lysoformin 3000, Melseptol, Melsept SF, Sanepidex, Cutasept F).

8.4. Autoclaving

- Rotors, buckets, and round carriers can be sterilized in autoclave with temperature 121°C during 20 min (215 kPa), unless otherwise specified in the OPTIONAL ACCESSORY.
- During sterilization (autoclaved) by means of steam one should consider temperature resistance of individual materials.
- Deformation of the accessories (carriers or lids made of plastic) may occur during autoclaving.
- Do not autoclave disposable materials (e.g., tubes, cyto-container).
- The life of the accessory depends on the frequency of autoclaving and use.
- Autoclaving reduces lifespan of plastic components. They should be replaced if any signs of damage are visible, including a change in colour or shape or when leakage etc.
- Pressure in closed containers can cause plastic deformation or explosion.
- Prior to autoclaving the rotors and accessories, thoroughly wash and rinse with distilled water.
- Never exceed the permissible autoclaving temperature and time.
- If you want to keep the hermetic seals, replace the sealing rings after each autoclave.

Chemical resistance of plastics

	autoclaving 121 °C, 20 min		autoclaving 121 °C, 20 min
PS	○	PMP	●
SAN	○	ECTFE, ETFE	●
PMMA	○	PTFE	●
PC	●	FEP, PFA	●
PVC	○ ¹⁾	FKM	●
POM	●	EPDM	●
PE-LD	○	NR	○
PE-HD	○	SI	●
PP	●		
●	may be used		
○	cannot be used		
1)	Except PVC hoses which are resistant to the steam sterilization in the temperature 121°C.		



8.5. Chemical resistance

Chemical resistance of plastics

	aldehydes	cyclic alcohols	esters	ether	ketones	strong or concentrated acids	weak or diluted acids	oxidizing substances	cyclic hydrocarbons	ahs	haloid hydrocarbons	alkalis
PS	○	●	○	○	○	○/●	○/●	○	○	○	○	●
SAN	○	●	○	○	○	○	○/●	○	○	○	○	●
PMMA	○/●	●	○	○	○	○	○/●	○	○/●	○	○	○
PC	○/●	●	○	○	○	○	○/●	○	○/●	○	○	○
PVC	○	●	○	○	○	●	●	○	●	○	○	●
POM	○/●	●	○	●	●	○	○	○	●	●	●	●
PE-LD		●	●	●	○/●	●	●	○	●	●	●	●
PE-HD	●	●	○/●	○/●	○/●	●	●	○	●	○/●	○/●	●
PP	●	●	○/●	○/●	○/●	●	●	○	●	○/●	○/●	●
PMP	○/●	●	○/●		○/●	●	●	○	○/●	○	○	●
ECTFE	●	●	●	●	○	●	●	●	●	●	●	●
ETFE	●	●	●	●	○	●	●	●	●	●	●	●
PTFE	●	●	●	●	●	●	●	●	●	●	●	●
FEP	●	●	●	●	●	●	●	●	●	●	●	●
PFA	●	●	●	●	●	●	●	●	●	●	●	●
FKM	●	○	○	○	○	○	●	○/●	○/●	○/●	○/●	○/●
EPDM	●	●	○/●	○	○/●	●	●	○/●	○	○	○	●
NR	○/●	●	○/●	○	○	○	○/●	○	○	○	○	●
SI	○/●	●	○/●	○	○	○	○/●	○	○	○	○	○/●
●	very good	Permanent action of the substance does not cause damage through 30 days. The material is able to be resistant through years										
○/●	good to limited	Continuous action of the substance causes insignificant and partly reversible damage through the period of 7-30 days (e.g., puffing up, softening, reduced mechanical durability, discoloring).										
○	limited	The material should not have the continuous contact with the substance. The immediate occurrence of damage is possible (e.g., the loss of mechanical durability, deformation, discoloring, bursting, dissolving).										

Rubber inserts shall be exactly cleaned or possibly replaced. Centrifuges and accessories are made of different materials.



Do not use bleach on plastic parts of the rotor.

	<p>DANGER!</p> <p>MPW accessories are not biotight. For centrifuging infectious materials, it is necessary to use hermetically closed tubes meeting demands of biotightness, in order to prevent germs migration into the centrifuge and beyond it.</p>
	<p>User is responsible for proper disinfections of the centrifuge if some dangerous material was spilled inside or outside of the centrifuge. During the above mentioned works one must wear safety gloves.</p>

9. Troubleshooting

Most errors can be corrected by switching the centrifuge off and on again. In the event of short-term power failures during operation, centrifugation is not continued. In order to centrifuge after power is restored, restart the centrifuge by pressing the **START** key.

The most common errors and how to fix them are shown below

1. Lack of the display:	Remedies:
<i>Is mains socket live ?</i>	<i>Check mains socket fuse.</i>
<i>Is supply cable plugged into socket ?</i>	<i>Plug correctly supply cable.</i>
<i>Is input fuse good ?</i>	<i>Replace input fuse (rated data on rating plate).</i>
<i>Is master switch switched ON ?</i>	<i>Switch ON power supply.</i>
<i>Above was checked and still there is not display active.</i>	<i>Call service.</i>
2. Centrifuge does not start:	Remedies:
<i>START key pushing does not generate reaction or single tone only</i>	<i>Call service</i>
<i>P message is displayed</i>	<i>Call service</i>
<i>The symbol  is displayed</i>	<p>Close the cover. The lock must close with a characteristic sound. A dot must appear in the display.</p> <p>If the symbol does not change to , call for service.</p>
3. Centrifuge starts but does not accelerate	Remedies:
<i>E symbol displayed after stopping. Drive overload.</i>	<i>Wait for 15 minutes and switch again after opening and closing the cover.</i>
4. One cannot open the cover:	Remedies:
<i>With the attempt opening cover is audible buzzing of the lock.</i>	<i>One should lift up till the yellow LED "Cover" is switching on. Failed spring of cover lifting or bended the lock striker. One should bend the striker or call service.</i>
<i>The symbol  is displayed and the centrifuge is not spinning.</i>	<i>Lock is failed. Call service.</i>

9.1. Emergency cover release

	<p>EMERGENCY COVER RELEASE</p> <p>Attention! <i>The cover may be opened in emergency only when the rotor is at rest. Before emergency opening the cover, switch off the mains power switch and disconnect the power cord. Wait 10 min and/or looking through the sight glass, make sure that the rotor is not rotating.</i></p> <p>To do this, insert emergency opening key (17162) into the hole and press to make the moment of the release of lock.</p> <p>The emergency opening of the cover can be used, for example, in the event of a power failure, failure of the control panel, etc.</p>
---	--

10. Guarantee

Manufacturer grants to the Buyer the guarantee on conditions specified in the Guarantee Certificate. Buyer forfeits the right to guarantee repair when using the device inconsistently with the User manual provisions, when damage results from the User's fault.

Repairs should be conducted in authorized service workshops, granted with the MPW Certificate.

The centrifuge shall be sent to repair after decontaminating disinfections. Information about authorized service workshops could be obtained from the Manufacturer.

	<ul style="list-style-type: none"> ▪ Guarantee period amounts to 24 months (unless otherwise specified in the purchase documents). ▪ Guarantee conditions are described in guarantee card.. ▪ The service life of the centrifuge specified by the manufacturer amounts to 10 years. ▪ After 24 months from the start of the warranty period (date of purchase), a technical inspection of the centrifuge should be carried out (validation) by an authorized service of the manufacturer. Subsequent inspections should be carried out at annual intervals. ▪ Maximum period of storage of not used centrifuge amounts to 1 year. After this period, a service authorized by manufacturer should carry out technical inspection of the centrifuge. ▪ Manufacturer reserves the right to make technical changes in manufactured products.
---	--

11. Transport and storage

<ul style="list-style-type: none"> ▪ Store the device only in a closed and dry room. ▪ Remove rotor from centrifuge before transport. ▪ Use the original packaging and transport protection for transport.

11.1. Transport and storage conditions

	Storage (in the package)	Storage (without the package)	Transport
Temperature	-25 ÷ +55 °C	-5 ÷ +45 °C	-25 ÷ +60 °C (general) -20 ÷ +55 °C (air)
Relative humidity	10 ÷ 75 %	10 ÷ 75 %	10 ÷ 75 %
Pressure	70 ÷ 106 kPa	70 ÷ 106 kPa	30 ÷ 106 kPa

11.1. Disposal

	<ul style="list-style-type: none"> ▪ Dispose of the device in accordance with the applicable legal regulations in the country of use. ▪ In the countries of the European Community, the disposal of electrical equipment is regulated under the EU Directive 2012/19/EU on waste electrical and electronic equipment (WEEE). According to these regulations, centrifuges may not be collected together with municipal or household waste. ▪ Disposal regulations in individual EU countries may differ. In case of doubt, please contact the supplier of the device.
---	---

12. Manufacturer's info

"MPW MED. INSTRUMENTS" SPÓŁDZIELNIA PRACY
Boremlowska 46 Street
04-347 Warsaw

tel. (+48) 22 610 56 67 (sales department - POLAND)
(+48) 22 879 70 46 (sales department - outside POLAND)
(+48) 22 610 81 07 (service)
fax (+48) 22 610 55 36
e-mail: mpw@mpw.pl
website: www.mpw.pl

000042924 - number of entry in the Waste Database

PL/CA01-01782 - identification number given by Office for Registration of Medicinal Products, Medical Devices and Biocidal Products

Distributor's info

DISTRIBUTOR:



13. Annexes

A. Wyposażenie dodatkowe/Optional accessories**MPW-54****WIRNIK / ROTOR**PARAMETRY WIRNIKA / ROTOR PARAMETERS (RCF [x g], Rmax [mm], α [°])

POJEMNIK/BUCKET

WKŁADKA / ADAPTER

[liczba probówek na wirnik/tubes per rotor] PROBÓWKA / TUBE

11101**RPM 5800 RCF 3122 Rmax 83 α 29**

13080

14082

[6] * BD Vacutainer® (13 x 100 mm), (4-7 ml)

[6] * Greiner Vacuette® (13 x 100 mm), (3,5-6 ml)

[6] * Sarstedt S-Monovette® (11 x 92 mm), (4,5; 5 ml)

[6] 15054 6 ml probówka z pokrywką (11,5 x 92 mm), Sarstedt®
6 ml tube with cap (11,5 x 92 mm), Sarstedt®[6] 15119 7 ml probówka szklana (12 x 100 mm)
7 ml glass tube (12 x 100 mm)

bez wkładki/without adapter

[6] * BD Vacutainer® (16 x 100 mm), (2,5-11 ml)

[6] * Greiner Vacuette® (16 x 100 mm), (7-9 ml)

[6] * Sarstedt S-Monovette® (15 x 92 mm), (7,5; 8,2; 8,5 ml)

[6] * Sarstedt S-Monovette® (16 x 92 mm), (9; 10 ml)

[6] 15046 14 ml probówka z pokrywką (16,8 x 113,7 mm), Sarstedt®
14 ml tube with cap (16,8 x 113,7 mm), Sarstedt®[6] 15048 15 ml Thermo Nalgene® (16 x 113 mm)
15 ml Thermo Nalgene® (16 x 113 mm)[6] 15053 10 ml probówka z pokrywką (16 x 106 mm)
10 ml tube with cap (16 x 106 mm)[6] 15118 10 ml probówka szklana (16 x 100 mm)
10 ml glass tube (16 x 100 mm)[6] * 15 ml probówka z dnem stożkowym z zakrętką (17 x 120 mm), Falcon®; [15050], 15ml (17 x 120 mm)
15 ml tube, conical bottom, with cap (17 x 120 mm), Falcon®; [15050] 15ml Sarstedt®(17 x 120 mm)**11101****RPM 5800 RCF 2595 Rmax 69 α 29**

13080

14082+14815 Rmax 69 RCF 2595

[6] * BD Vacutainer® (13 x 75 mm), (1,6-5,3 ml)

[6] * Greiner Vacuette® (13 x 75 mm), (1-4,5 ml)

[6] * Sarstedt S-Monovette® (11 x 66 mm), (1,6; 2; 2,7; 3; 3,1 ml)

[6] * Sarstedt S-Monovette® (13 x 65 mm), (2,6; 2,9; 3,4; 3,8 ml)

[6] * Sarstedt S-Monovette® (13 x 75 mm), (2,7; 3; 4,3 ml)

[6] 15120 5 ml probówka szklana (12 x 75 mm)
5 ml glass tube (12 x 75 mm)

14815 Rmax 69 RCF 2595

[6] * Sarstedt S-Monovette® (15 x 75 mm), (4; 4,3; 5,5 ml)

[6] * 10 ml Thermo Nalgene® Oak Ridge (16 x 81,5 mm)

[6] 15121 10 ml probówka z dnem okrągłym i pokrywką (17 x 70 mm)
10 ml tube, round bottom, with cap (17 x 70 mm)**11144****RPM 5800 RCF 3122 Rmax 83 α 29**

13080

14082

[4] * BD Vacutainer® (13 x 100 mm), (4-7 ml)

[4] * Greiner Vacuette® (13 x 100 mm), (3,5-6 ml)

[4] * Sarstedt S-Monovette® (11 x 92 mm), (4,5; 5 ml)

[4] 15054 6 ml probówka z pokrywką (11,5 x 92 mm), Sarstedt®
6 ml tube with cap (11,5 x 92 mm), Sarstedt®

A. Wyposażenie dodatkowe/Optional accessories**MPW-54**

[4]	15119	7 ml probówka szklana (12 x 100 mm) 7 ml glass tube (12 x 100 mm)
		bez wkładki/without adapter
[4]	*	BD Vacutainer® (16 x 100 mm), (2,5-11 ml)
[4]	*	Greiner Vacuette® (16 x 100 mm), (7-9 ml)
[4]	*	Sarstedt S-Monovette® (15 x 92 mm), (7,5; 8,2; 8,5 ml)
[4]	*	Sarstedt S-Monovette® (16 x 92 mm), (9; 10 ml)
[4]	*	15 ml probówka z dnem stożkowym z zakrętką (17 x 120 mm), Falcon®; [15050], 15ml (17 x 120 mm) 15 ml tube, conical bottom, with cap (17 x 120 mm), Falcon®; [15050] 15ml Sarstedt®(17 x 120 mm)
[4]	15046	14 ml probówka z pokrywką (16,8 x 113,7 mm), Sarstedt® 14 ml tube with cap (16,8 x 113,7 mm), Sarstedt®
[4]	15048	15 ml Thermo Nalgene® (16 x 113 mm) 15 ml Thermo Nalgene® (16 x 113 mm)
[4]	15053	10 ml probówka z pokrywką (16 x 106 mm) 10 ml tube with cap (16 x 106 mm)
[4]	15118	10 ml probówka szklana (16 x 100 mm) 10 ml glass tube (16 x 100 mm)

11144**RPM 5800 RCF 2595 Rmax 69 ϕ 29**

13080

14082+14815 Rmax 69 RCF 2595

[4]	*	BD Vacutainer® (13 x 75 mm), (1,6-5,3 ml)
[4]	*	Greiner Vacuette® (13 x 75 mm), (1-4,5 ml)
[4]	*	Sarstedt S-Monovette® (11 x 66 mm), (1,6; 2; 2,7; 3; 3,1 ml)
[4]	*	Sarstedt S-Monovette® (13 x 65 mm), (2,6; 2,9; 3,4; 3,8 ml)
[4]	*	Sarstedt S-Monovette® (13 x 75 mm), (2,7; 3; 4,3 ml)
[4]	15120	5 ml probówka szklana (12 x 75 mm) 5 ml glass tube (12 x 75 mm)
		14815 Rmax 69 RCF 2595
[4]	*	Sarstedt S-Monovette® (15 x 75 mm), (4; 4,3; 5,5 ml)
[4]	*	10 ml Thermo Nalgene® Oak Ridge (16 x 81,5 mm)
[4]	15121	10 ml probówka z dnem okrągłym i pokrywką (17 x 70 mm) 10 ml tube, round bottom, with cap (17 x 70 mm)

11145**RPM 5800 RCF 3122 Rmax 83 ϕ 29**

13080

14082

[8]	*	BD Vacutainer® (13 x 100 mm), (4-7 ml)
[8]	*	Greiner Vacuette® (13 x 100 mm), (3,5-6 ml)
[8]	*	Sarstedt S-Monovette® (11 x 92 mm), (4,5; 5 ml)
[8]	15054	6 ml probówka z pokrywką (11,5 x 92 mm), Sarstedt® 6 ml tube with cap (11,5 x 92 mm), Sarstedt®
[8]	15119	7 ml probówka szklana (12 x 100 mm) 7 ml glass tube (12 x 100 mm)
		bez wkładki/without adapter
[8]	*	BD Vacutainer® (16 x 100 mm), (2,5-11 ml)
[8]	*	Greiner Vacuette® (16 x 100 mm), (7-9 ml)
[8]	*	Sarstedt S-Monovette® (15 x 92 mm), (7,5; 8,2; 8,5 ml)
[8]	*	Sarstedt S-Monovette® (16 x 92 mm), (9; 10 ml)
[8]	15046	14 ml probówka z pokrywką (16,8 x 113,7 mm), Sarstedt® 14 ml tube with cap (16,8 x 113,7 mm), Sarstedt®
[8]	15048	15 ml Thermo Nalgene® (16 x 113 mm) 15 ml Thermo Nalgene® (16 x 113 mm)
[8]	15053	10 ml probówka z pokrywką (16 x 106 mm) 10 ml tube with cap (16 x 106 mm)
[8]	15118	10 ml probówka szklana (16 x 100 mm) 10 ml glass tube (16 x 100 mm)
[4]	*	15 ml probówka z dnem stożkowym z zakrętką (17 x 120 mm), Falcon®; [15050], 15ml (17 x 120 mm) 15 ml tube, conical bottom, with cap (17 x 120 mm), Falcon®; [15050] 15ml Sarstedt®(17 x 120 mm)

11145**RPM 5800 RCF 2595 Rmax 69 ϕ 29**

13080

14082+14815 Rmax 69 RCF 2595

[8]	*	BD Vacutainer® (13 x 75 mm), (1,6-5,3 ml)
-----	---	---

A. Wyposażenie dodatkowe/Optional accessories**MPW-54**

[8]	*	Greiner Vacuette® (13 x 75 mm), (1-4,5 ml)
[8]	*	Sarstedt S-Monovette® (11 x 66 mm), (1,6; 2; 2,7; 3; 3,1 ml)
[8]	*	Sarstedt S-Monovette® (13 x 65 mm), (2,6; 2,9; 3,4; 3,8 ml)
[8]	*	Sarstedt S-Monovette® (13 x 75 mm), (2,7; 3; 4,3 ml)
[8]	15120	5 ml probówka szklana (12 x 75 mm) 5 ml glass tube (12 x 75 mm)
		14815 Rmax 69 RCF 2595
[8]	*	Sarstedt S-Monovette® (15 x 75 mm), (4; 4,3; 5,5 ml)
[8]	*	10 ml Thermo Nalgene® Oak Ridge (16 x 81,5 mm)
[8]	15121	10 ml probówka z dnem okrągłym i pokrywką (17 x 70 mm) 10 ml tube, round bottom, with cap (17 x 70 mm)

Suma końcowa

EU DECLARATION OF CONFORMITY

This EU declaration of conformity is issued under the sole responsibility of the manufacturer.

Manufacturer: **"MPW MED. INSTRUMENTS" SPÓŁDZIELNIA PRACY**
46 Boremłowska Street, 04-347 Warsaw, Poland

We apply the certified
Quality Management System
in accordance
with the standards: **PN-EN ISO 9001:2015, PN-EN ISO 13485:2016**

Product name: **Laboratory centrifuge MPW-54**

The aforementioned product is in conformity with the following EU regulations and directives:

- **2017/746 (IVDR)** REGULATION (EU) 2017/746 OF THE EUROPEAN PARLIAMENT AND OF THE COUNCIL of 5 April 2017 on in vitro diagnostic medical devices and repealing Directive 98/79/EC and Commission Decision 2010/227/EU
- **2011/65/UE (RoHS 2)** DIRECTIVE 2011/65/EU OF THE EUROPEAN PARLIAMENT AND OF THE COUNCIL of 8 June 2011 on the restriction of the use of certain hazardous substances in electrical and electronic equipment

Intended purpose: The product is a benchtop laboratory centrifuge specifically intended by the manufacturer for in vitro diagnostic (IVD) procedures. It is used for the separation of mixtures, suspensions, body fluids into components of different density under the influence of centrifugal force.

Risk class: **Class A (in accordance with Annex VIII, rule 5)**

The assessment of the conformity of the device has been carried out in accordance with Article 48(10) of Regulation (EU) 2017/746.

Wojciech Anisiewicz
Vice-President of the Management Board

Łukasz Sałański
President of the Management Board

DECLARATION OF DECONTAMINATION

(repair)

In order to protect our employees please fill out the declaration of decontamination completely before sending centrifuge to the manufacturer (repair).

1. Device:

– type:

– serial No.:

2. Description of decontamination

(see user manual)

.....

.....

.....

.....

3. Decontamination carried out by:

name:

4. Date and signature:

.....

DECLARATION OF DECONTAMINATION

(return)

In order to protect our employees please fill out the declaration of decontamination completely before sending centrifuge to the manufacturer (return).

1. Device:

– type:

– serial No.:

2. Description of decontamination

(see user manual)

.....
.....
.....
.....

3. Decontamination carried out by:

name:

4. Date and signature:

.....

NOMOGRAM

Centrifuging radius [cm]

R.C.F. (x "g")
multiple of
gravitational
acceleration

[r.p.m.]

