

USER MANUAL



Refrigerated laboratory centrifuge **MPW-150R**

Read before use!

Serial number of the centrifuge:

For centrifuges with serial no (SN): from 10150R046622

This manual was prepared with special care. MPW MED. INSTRUMENTS may change the manual at any time and without notice because of improvements, typographical errors, or improvements to facilities

All rights reserved. No part of this User Manual may be modified, distributed, published, or reproduced without the prior permission of MPW MED. INSTRUMENTS.

You can find the current version of the user manual on our website under:









www.mpw.pl DOWNLOAD section (one should choose demanded language version of website).

Contents

1	Symbols used in the manual and on the device	5
2	Application	5
3	Technical specification	6
3.1	Environmental conditions	6
4	Installation	7
4.1	Content of package	7
4.2	Location	7
4.3	Current protection	8
5	Safety notes	8
5.1	General remarks	8
5.2	Filling the rotor	8
5.3	Safety hints	9
5.4	Operating conditions	10
5.5	Equipment life	10
5.6	Work safety	10
5.7	Unbalance	11
5.8	Emergency stop	11
5.9	Residual risk	12
6	Operating	12
5.1.	Centrifuge overview	12
5.2.	Centrifuge description	12
6.3	Construction	13
6.4	Name plate	13
6.5	Rotor and accessories installation	13
6.6	Control device	14
6.7	Setting parameters	14
6.8	Safety features	14
7	Centrifuging	14
7.1	Control panel	14
7.2	Display	15
7.3	Setting up RPM, RCF, time, temperature	17
7.4	Users programs	19
7.5	Creator of acceleration and deceleration curves	20
7.6	Programs with user characteristics	24
7.7	Rotor and bucket choosing	25
7.8	SHORT mode	25
7.9	Finishing the centrifuging	26
8	Temperature control	26
8.1	Initial cooling during centrifuging - FAST COOL	27
8.2	Initial cooling without centrifuging – THERMAL CHAMBER	27
8.3	Cooling in “START DELAY – OF TEMPERATURE” mode	27
8.4	Cooling in „SHORT” mode	28
8.5	Cooling notes	28
9	Parameters of centrifugation	28
9.1	Acceleration/deceleration – changing characteristics	29
9.2	Radius	29

9.3	Sample density.....	29
9.4	Temperature offset.....	30
9.5	Thermal chamber.....	30
9.6	Automatic lid opening.....	31
9.7	Start delay - of time	31
9.8	Start delay – of temperature	32
9.9	Temporarily disabled functions	32
9.10	Printing report (USB).....	33
10	Menu	36
10.1	Screen saver	36
10.2	Visual alarm	37
10.3	Types of main screen	37
10.4	Rotating runtime.....	39
10.5	Buzzer	39
10.6	Date/time.....	40
10.7	Language	40
10.8	Other.....	40
10.9	Password.....	41
10.10	Last 10 cycles	43
10.11	Work time	43
10.12	Rotor runtime	43
10.13	Contact us	44
10.14	Diagnostics	44
10.15	Factory settings.....	44
11	Maintenance.....	45
11.1	Cleaning of the centrifuge	45
11.2	Maintenance of centrifuge elements	45
11.3	Sterilization	46
11.4	Chemical resistance	48
12	Troubleshooting	48
12.1	Messages	49
12.2	Emergency cover release	50
13	Guarantee.....	50
14	Transport and storage.....	51
14.1	Transport and storage conditions.....	51
15	Disposal	51
16	Manufacturer’s info	52
	Distributor’s info	52
17	Annexes	52
A.	Additional accessories	
B.	Declaration of conformity (CE, ROHS 2)	
C.	Declaration of decontamination (repair / return)	
D.	Nomogram RPM / RCF	

1 Symbols used in the manual and on the device

Symbol	Explanation
	WARNING! Warning of potential injury or health risk
	DANGER! Risk of electric shock with potential for severe injury or death as a consequence
	DANGER! Biohazard with potential for risk to health or death as a consequence
	DANGER! Risk of explosion with potential for severe injury or death as a consequence
	Symbol identifying a medical device for in vitro diagnostic use
	CE mark
	Symbol informing about the method of disposal
	Please read the instruction manual before you start working with the device
	Manufacturer's data

The terms "**accessories**", "**optional accessories**" and "**equipment**" used in this manual mean the components of the centrifuge, such as: rotors, containers and reducing inserts.

2 Application

- The **MPW-150R** centrifuge is a bench-top non-automatic laboratory centrifuge with refrigeration.
- The device is intended for In Vitro Diagnostics (IVD). This means that it is an in vitro diagnostic medical device - in accordance with the Regulation of the European Parliament and of the Council (EU) of 5 April 2017 on in vitro diagnostic medical devices and repealing Directive 98/79/EC and Commission Decision 2010 /227/EU.
- The centrifuge is used to separate aqueous solutions and suspensions of samples with a density not higher than 1.2g/cm³ taken from human, animal and plant organisms into components of different densities under the influence of centrifugal force, in order to provide information about their biological state and to other analytical work.

- The design of the centrifuge ensures ease of use, safe operation and a wide range of applications in medical, biochemical and other analysis laboratories.
- The centrifuge is not biotight, therefore, when centrifuging preparations that require biotightness, containers and rotors with a biotightness certificate should be used.

3 Technical specification

manufacturer	"MPW MED. INSTRUMENTS" SPÓŁDZIELNIA PRACY, Boremłowska 46 Street, 04-347 Warszawa			
type	MPW - 150R			
cat. no. (REF)	10150R/2-5	10150R/1-6		
mains voltage (L1+N+PE)	230V	100V	110V	120V 127V
	±10%	±5%		
frequency, ±1%	50 Hz	60Hz		
Power consumption (max)	500W	500W		
current protection	T 6,3 A	T 10 A		
cooling medium	R452A (CFC/HCFC free)			
capacity (max)	90ml (6x15ml)			
Speed (rpm)	90 ÷ 15000 rpm (step 1 rpm)			
g-force (RCF)	21382 x g (step 1 x g)			
running time	00:00:01 ÷ 99:59:59 – [h. : min : s] (1s step)			
time counting	since start button is pressed / since preselected speed is reached			
short time operation mode	yes			
continuous operation mode	yes			
menu languages	English, Spanish, Italian, Portuguese, German, Russian, Polish, Swedish, French, Czech			
number of programs	100			
adjustable temperature	-20 ÷ 40°C* (step 1°C)			
initial cooling (FASTCOOL)	yes			
guaranteed temperature with max. rotor speed	≤4°C			
cooling without centrifuging	yes			
acceleration (ACEL)	10 linear characteristics			
deceleration (DECEL)	10 linear characteristics			
USB communication	yes			
electromagnetic compatibility	accordance with EN 61326-2-6:2006			
Degree of protection: (according to PN-IEC 34-5)	IP20			
noise level	≤60dB			
weight	approx. 30,5 kg	approx. 33kg		
dimensions:				
height (H)	285 mm			
width (W)	299 mm			
depth (D)	595 mm			
height with open lid (H _{oc})	565 mm			

*time and possibility of obtaining a set temperature is dependent on multiple factors , including rotor type, established RPM, ambient temperature; accuracy: - ±1°C appropriate for place of temperature sensor

3.1 Environmental conditions

- The device may only be used indoors.
- The permissible ambient temperature is 2°C to 40°C.
- Maximum allowed relative humidity 80% at temperature up to 31°C decreasing linearly to 50% relative humidity at 40°C.
- The mains voltage fluctuations must not exceed ± 10% of the nominal voltage.
- Maximum altitude 2,000 m above sea level.
- Overvoltage category II.
- Pollution degree 2.



4 Installation

Open the package. Take out the box containing the accessories. Take out centrifuge from the container. Keep the box and packing materials in case of service shipping.

4.1 Content of package

name	pcs	cat. no.
centrifuge MPW-150R	1	10150R/2-5 or 10150R/1-6
complete clamp	1	17142
spanner for a rotor	1	17099T
key for emergency lock release	1	18640
power cord 230V / power cord 120V	1	17866/17867
fuse WTA T10 250V / WTA T6,3 250V	2	17863/17862
petroleum jelly 20ml	1	17201
USB A-A cable	1	16655
user manual	1	See page 1.

4.2 Location

	<ul style="list-style-type: none"> ▪ The device is heavy, so lifting and carrying the centrifuge can lead to back injuries. Risk of injury while lifting and carrying heavy loads. ▪ Lifting and transporting of the centrifuge should be done with a sufficient number of helpers. Use a transport aid for transporting the centrifuge. ▪ The device should be lifted by the underside in the vicinity of its feet and placed directly on a suitable lab table. ▪ Ensure safe location. ▪ The centrifuge shall not be located near source of heat and shall not be subjected to direct sunlight. ▪ Centrifuge should be flat-levelled. Effect of levelling shall be ensured by stable and flat-levelled tabletop for the centrifuge. ▪ Centrifuge should be set horizontally on a rigid base. ▪ It is necessary to ensure a ventilation zone of the minimum 30cm round the centrifuge from every direction. Do not veil ventilation holes ! ▪ Table for centrifuge should possess safety zone of the minimum 30cm round the centrifuge from every direction (safety needs in case of malfunction according to EN 61010-020). ▪ Table for centrifuge should be free of containments before locating of centrifuge. ▪ Passed parameters of the centrifuge are referring to the above-named temperatures (Technical specification). ▪ At the change of the place from cold to warm one, condensation of water will occur inside the centrifuge. It is important then that sufficient time be provided for drying the centrifuge prior to starting the centrifuge again (min. 4 hours).
	<ul style="list-style-type: none"> ▪ Do not position the centrifuge so that it is difficult to operate the power switch ▪ Supply voltage given on the rating plate has to be consistent with local supply voltage. MPW MED INSTRUMENTS laboratory centrifuges are 1st safety class devices and they are provided with the three-core cable with the plug resistant to dynamic loadings. Mains socket shall be provided with the safety pin - protective earth (PE). ▪ It is recommended to install emergency cut-out that shall be located far from the centrifuge, near the exit or beyond the room.
	<ul style="list-style-type: none"> ▪ Before switching on, check whether the centrifuge is connected to power

	supply correctly. It is obligatory to use only power cord recommended by manufacturer.
--	----------------------------------------------------------------------------------------

4.3 Current protection

	The centrifuge is equipped with current protection (safety fuse). Fuse is situated in the plug-in socket unit at back wall of the centrifuge.
-----------------------------------------------------------------------------------	-----------------------------------------------------------------------------------------------------------------------------------------------

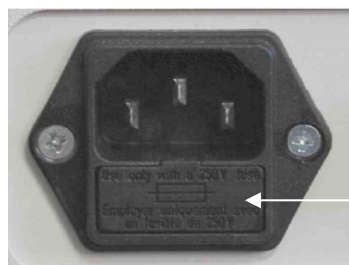

Safety fuse



Fig.1 Plug-in socket unit

5 Safety notes

5.1 General remarks

	<ul style="list-style-type: none"> ▪ The laboratory centrifuge may be operated only by qualified laboratory personnel after getting acquainted with the user's manual. ▪ The operating instructions are part of the product. ▪ The instruction manual should always be kept near the centrifuge. ▪ The centrifuge cannot be operated inconsistently with its purpose. ▪ If the centrifuge is used in a manner inconsistent with the manufacturer's guidelines, the safety of the device operation may be impaired.
-------------------------------------------------------------------------------------	--------------------------------------------------------------------------------------------------------------------------------------------------------------------------------------------------------------------------------------------------------------------------------------------------------------------------------------------------------------------------------------------------------------------------------------------------------------------------------------------------------------------------------------------------------------------------------------------

5.2 Filling the rotor

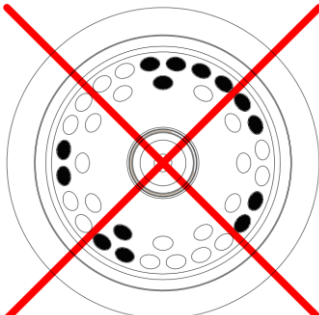
	<ul style="list-style-type: none"> ▪ Check that the rotor is properly seated and bolted to the motor axis. ▪ Do not exceed the maximum rotor load (information is provided on the rotors). ▪ In order to ensure symmetrical loading, fill opposite openings of the rotor with inserts and test tubes of the same type and weight. <div style="display: flex; justify-content: space-around; align-items: center;">   </div>
-------------------------------------------------------------------------------------	--------------------------------------------------------------------------------------------------------------------------------------------------------------------------------------------------------------------------------------------------------------------------------------------------------------------------------------------------------------------------------------------------------------------------------------------------------------------------------------------------------------------------------------------------------------------------------------------------------------------------------------------

5.2.1 Filling tubes

	<ul style="list-style-type: none"> ▪ Tubes may only be filled outside the centrifuge. ▪ Tubes may only be filled with the maximum amount of substance specified by the manufacturer. ▪ The test tubes must be filled in such a way that the centrifuged substance does not run out of the vessel during centrifugation.
-------------------------------------------------------------------------------------	-----------------------------------------------------------------------------------------------------------------------------------------------------------------------------------------------------------------------------------------------------------------------------------------------------------------------------------------------------------------

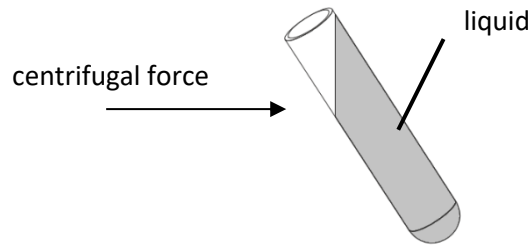

- In case the tube manufacturer has not specified a maximum level, fill the tubes according to the formula:

$$\text{Max liquid level} < \text{Tube height} - \frac{\text{Internal tube diameter}}{2}$$

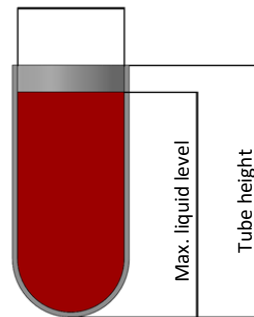





- For centrifugation in the centrifuge, only containers included in the list of equipment and centrifuge tubes, the diameter, length and strength of which are appropriate, should be used. The use of test tubes from other manufacturers should be agreed with MPW MED. INSTRUMENTS or its authorized representatives.
- Pay attention to the quality and appropriate thickness of the walls of glass test tubes. **Glass tubes should be centrifuge tubes.**
- To prevent the centrifuge from being unbalanced, it is recommended to weigh the filled test tubes before inserting them into the rotor. When centrifuging in horizontal rotors, it is recommended to weigh the filled containers / hangers. This will allow to minimize the differences in mass between them, which will positively affect the suspension of the engine and the reduction of noise level during the operation of the centrifuge.

5.3 Safety hints

	<p>ROTORS MAINTENANCE</p> <ul style="list-style-type: none"> ▪ Lubricate the swing-out rotor journal pins. ▪ Use only accessories in good condition. ▪ Protect equipment against corrosion using accurate preventive maintenance.
	<p>HS ACCESSORIES MAINTENANCE</p> <ul style="list-style-type: none"> ▪ Make sure that rubber O-rings are lightly coated with petroleum jelly (to ensure vacuum). Use high vacuum grease, e.g., type „C” by LUBRINA.
	<p>HAZARDOUS MATERIALS</p> <ul style="list-style-type: none"> ▪ MPW accessories are not biotight. For centrifuging infectious materials, it is necessary to use hermetically closed tubes meeting demands of biotightness, in order to prevent germs migration into the centrifuge and beyond it. ▪ It is not allowed to subject to centrifugation toxic materials with damaged leak proof seals of the rotor or test-tube. Proper disinfection procedures have to be

	carried out when dangerous substances contaminated the centrifuge or its accessories.
	<p>EXPLOSIVE AND COMBUSTIBLE MATERIALS</p> <ul style="list-style-type: none"> ▪ It is not allowed to centrifuge explosive and inflammable materials. ▪ It is not allowed to centrifuge substances prone to reacting in result of supplying high energy during centrifugation. ▪ The centrifuge cannot be operated in explosion-endangered areas. ▪ It is not allowed to centrifuge materials capable of generating inflammable or explosive mixtures when subjected to air.

5.4 *Operating conditions*

	<p>START-UP</p> <ul style="list-style-type: none"> ▪ Prior to switching the centrifuge on, one shall read carefully all sections of this instruction in order to ensure smooth operation and avoid damages of this device or its accessories. ▪ In order to protect the centrifuge against unbalance, fill in the test tubes up to the same weight.
	<p>TRANSPORTATION</p> <ul style="list-style-type: none"> ▪ Centrifuge must not be transported with the rotor mounted on the shaft.
	<p>GENERAL HINTS</p> <ul style="list-style-type: none"> ▪ One must use original rotors, test-tubes and spare parts only. ▪ In case of faulty operation of the centrifuge one shall ask for assistance service of MPW MED. INSTRUMENTS company or its authorized representatives. ▪ It is not allowed to switch the centrifuge on if it is not installed properly or rotor is not fitted correctly.
	<p>CENTRIFUGING SUBSTANCES</p> <p>It isn't allowed to exceed load limit set by the manufacturer. Rotors are intended for fluids of average homogeneous density equal to 1,2 g/cm³ or smaller when centrifugation is carried out at maximum speed. When fluids of higher density shall be used, then it is necessary to change density of centrifuges sample in PARA/DENSITY field.</p>

5.5 *Equipment life*

	<ul style="list-style-type: none"> ▪ Each spin cycle during which the rotor has accelerated and decelerated is considered a duty cycle, regardless of the speed and its duration. ▪ Do not use the equipment after the allowable number of cycles or when the maximum service life has passed, whichever comes first.
--	-----------------------------------------------------------------------------------------------------------------------------------------------------------------------------------------------------------------------------------------------------------------------------------------------------------------------------------------------

5.6 *Work safety*

The centrifuge should be inspected by an authorized service at least once a year (after the warranty period). The reason for more frequent inspection may be, for example, a corrosive environment. Tests should end with issuing a validation protocol, which specifies checking the technical condition of a laboratory centrifuge. It is recommended that you create a document that records all repairs and inspections. Both these documents should be kept in the place where the centrifuge is used.

	<p>INSPECTION PROCEDURES CARRIED OUT BY THE OPERATOR</p> <p>Operator has to pay special attention to the fact that the centrifuge parts of key importance due to safety reasons are not damaged. This remark is specifically important as for:</p>
-------------------------------------------------------------------------------------	-----------------------------------------------------------------------------------------------------------------------------------------------------------------------------------------------------------------------------------------------------------

	<ul style="list-style-type: none"> ▪ Centrifuge accessories and especially structural changes, corrosion, preliminary cracks, abrasion of metal parts. ▪ Screw connections. ▪ Inspection of seals of the buckets if such are used. Special attention must be paid to all of the rubber (seals) parts. In the case of damage or visible structural changes defective parts must be replaced for new immediately. ▪ Control of execution of the guarantee yearly technical inspection of the centrifuge (after lapse of guarantee). ▪ Only the manufacturer-specified buckets, included in the equipment list, as well as centrifuge tubes, which diameter, length and durability are suitable, should be used for spinning in this centrifuge. The use of equipment made by other manufacturers should be consulted with the manufacturer of the centrifuge. ▪ It is not allowed to lift or shift the centrifuge during operation, and rest on it. ▪ It is not allowed to stay in the safety zone within 30 cm distance around the centrifuge neither leave within this zone some things, e.g., glass vessels. ▪ It is not allowed to put any objects on the centrifuge.
	<p style="text-align: center;">COVER OPENING</p> <ul style="list-style-type: none"> ▪ It is not allowed to open the cover manually in emergency procedure when rotor is still turning.

	<p style="text-align: center;">ROTORS</p> <ul style="list-style-type: none"> ▪ It is not allowed to use the rotors, buckets and round carriers with signs of corrosion or other mechanical damage. ▪ It is not allowed to centrifuge substances of high corrosive aggressiveness, which may damage the materials and reduce the mechanical properties of rotors, buckets and round carriers. ▪ It is not allowed to centrifuge rotors with removed or loose covers.
-------------------------------------------------------------------------------------	-------------------------------------------------------------------------------------------------------------------------------------------------------------------------------------------------------------------------------------------------------------------------------------------------------------------------------------------------------------------------------------------------------------------------------------------------------------------------------------------------------------

5.7 Unbalance

The centrifuge is provided with the rotor unbalance sensor and when it will be activated, centrifugation process will be stopped through fast braking and at the same time an error message will be displayed. Erasing the error message is possible by pressing any key (**BACK, STOP, COVER, SET** and **▲ ▼ ◀▶**) after stopping the rotor.

One must check if rotor was correctly loaded, close the cover and once more start the program. In order to protect the rotor against improper work, it has to be provided with identically filled buckets, carriers, test-tubes etc. for getting the best balance possible (see section “**Błąd! Nie można odnaleźć źródła odwołania.**”).

Then close the cover and restart the program.

	<p>Unbalance causes noise and vibrations during operation, and adversely affects power transmission system (motor, shock absorbers). The better balance, the smoother will be the centrifuge operation and therefore longer life of usage of the driveline. Moreover, the ideal separation level is then obtained, as already separated constituents would not be moved up by vibration.</p>
-------------------------------------------------------------------------------------	----------------------------------------------------------------------------------------------------------------------------------------------------------------------------------------------------------------------------------------------------------------------------------------------------------------------------------------------------------------------------------------------

5.8 Emergency stop

In any moment of centrifuging, it is possible interrupt the process and fast stop the rotor. Single-time pressing of the **STOP** key will make centrifuging stop with acceleration characteristics set in the program (after pressing the **SET** or **STOP** key, the device returns to the main screen). Pressing and holding it up to 1s will make the centrifuging stop with the strictest characteristic.

5.9 Residual risk

The centrifuge is built according to the state-of-the-art and the recognized safety regulations. Nevertheless, still remain some level of residual risk due to improper operation and malfunctions. It is possible to decrease residual risk by strictly applying user manual conditions and correcting malfunction which could threaten safety, immediately.

6 Operating

5.1. Centrifuge overview

New generation of MPW MED. INSTRUMENTS laboratory centrifuges is provided with state-of-the-art microprocessor control systems, very durable and quiet asynchronous brushless motors and accessories consistent with requirements of the present-day user.

5.2. Centrifuge description

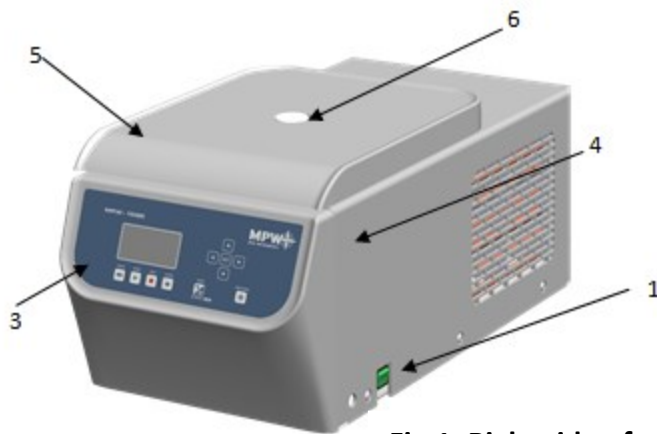

Fig.1. Right side of centrifuge

1. Power switch
2. USB
3. Control panel
4. Point of emergency lid opening
5. Lid
6. Inspection glass

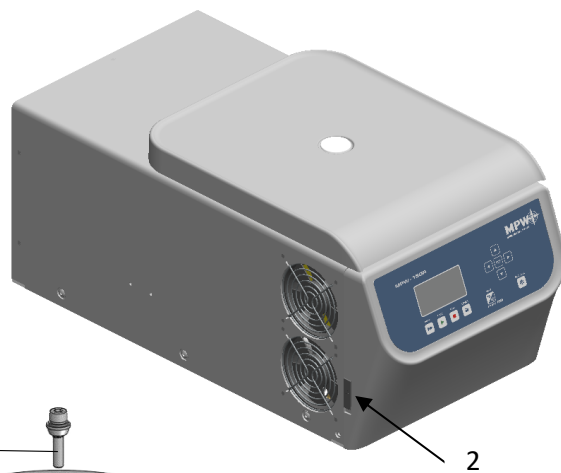

Fig.2. Left side of centrifuge

Fig.4. Mains socket back of the centrifuge

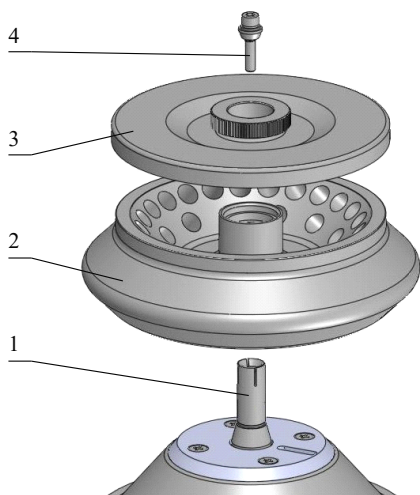
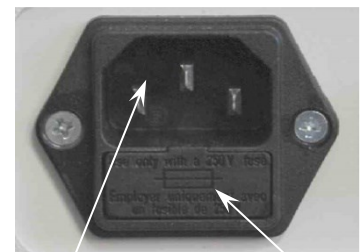

Fig.3. Assembly of angle rotor

1. Motor axle
2. Rotor
3. Rotor lid
4. Complete clamp



- 1
- 2
1. Plug-in socket
2. Fuse socket

6.3 Construction

The centrifuge has rigid self-supporting structure. Housing was made of sheet aluminium, back made of steel sheet. Front and cover were made of ABS. Cover is fixed on steel axles of hinges and from the front it is locked with electric lock blocking possible opening during centrifugation. The rotation chamber bowl is made of stainless-steel sheet.

6.4 Name plate

The data concerning the device should be read from the rating plate located on the rear wall of the centrifuge (the picture below is an example).

1	Model	MPW-150R
2	REF	10150R/2-5
3	n	15000 rpm
4	AC	230 V
5	P	430 W
6	SN	10150R000122
7	Date of production	2022-11-17
8	Manufacturer's information	"MPW MED. INSTRUMENTS" SPÓŁDZIELNIA PRACY ul. Boremłowska 46, 04-347 Warszawa, POLAND
9	Rated frequency	50 Hz
10	Current protection	T 6,3 A
11	Manufacturer's logo	MPW MED. INSTRUMENTS
12	Approval marks and symbols	IVD CE
13	QR code for serial number	[QR Code]
14	Information about the refrigerant	R452A: 0,165 kg 0,36 t eq CO ₂ GWP=2141 CFC FREE fluorinated greenhouse gas / hermetically sealed refrigeration system

1	Centrifuge model	9	Rated frequency
2	Catalog number	10	Current protection
3	Maximum speed	11	Manufacturer's logo
4	Rated voltage	12	Approval marks and symbols (explained in chapter 1)
5	Maximum rated power	13	QR code for serial number
6	Serial number	14	Information about the refrigerant
7	Date of production		
8	Manufacturer's information		

6.5 Rotor and accessories installation



- Connect the centrifuge to the power source (mains socket at the back of the centrifuge).
- Turn on the centrifuge (switch on the side of the centrifuge).
- Open the cover of the centrifuge by pressing the COVER key. Before installing the rotor, check that the centrifugation chamber is free from contamination, e.g., dust, glass splinters, liquid residues that must be removed.
- Put the rotor on the motor axis by sliding it onto the cone as far as it will go (keeping the coaxially between the rotor and the motor axis).
- Screw the clamp into the motor shaft (clockwise), then tighten it firmly with the rotor wrench.
- Swinging rotors must be equipped with buckets in all seats.
- Container suspension pins should be regularly lubricated with technical petroleum jelly.
- In the case of rotors with a cover, they must not be used without the cover. Rotor caps must be screwed securely onto the rotor. The rotor and cover are marked with the same catalog number (REF) to eliminate the risk of incorrect selection when the user has several types of rotors. Rotor covers ensure lower rotor resistance, correct tube seating and airtight sealing.
- Only containers suitable for the selected type of rotor should be used.
- In order to increase the durability of the rotor and seals, it is recommended to lubricate the rotor pins used to suspend the containers, the undercuts for the pins in the containers, gaskets and threaded places with technical petroleum jelly.
- In order to replace the rotor, remove the tubes and containers, loosen the rotor clamp with the provided wrench, counterclockwise, and then use both hands to grasp the rotor

on opposite sides and remove it from the motor axis by pulling it upwards.



It is recommended to equalize vessels loads, as much as possible in order to ensure minimal vibrations during operation.

6.6 Control device

The microprocessor control unit of the centrifuge ensures broad possibilities of providing, realisation and reading of work parameters.

6.7 Setting parameters

Data setting and read-out system forms hermetically closed keyboard with distinctly accessible operation points. Easily readable displays signalling individual performed operations facilitate operator's programming and recording of parameters and condition of the centrifuge. The centrifuge is provided with the USB interface that enables connection of the centrifuge to external PC unit with the printer and recording the centrifugation parameters.

6.8 Safety features

Cover lock

The centrifuge can be started only with properly closed cover. While the cover can be opened only after stopping the rotor. In case of emergency opening of the cover during operation, the centrifuge will be immediately switched-off and the rotor will brake till complete stopping. During cover closing it is prohibited to press any buttons. Do not place fingers into closing area during cover closing.



Unbalance detecting

When loads of opposite buckets or carriers in rotors are unbalanced, the drive will be switched-off during acceleration or operation of the centrifuge – and the error message will be displayed.

Rotor verification and checking compatibility with set program

Directly after starting centrifuging, a unit verifies the type of the rotor applied and in the case of its incompatibility with the type indicated in the application or absence of the rotor, the spinning process shall be stopped with simultaneous displaying the error message. The conformity of the type of the rotor is signalled with a single audible signal. In case auto identification (see Other) option is checked, proper rotor will be automatically chosen, without user engagement.

Rest state inspection

Opening the centrifuge lid with the **COVER** key is possible only when the rotor is at rest. Check that the symbol  described in the **Display** chapter is visible on the screen. Use the sight glass on the cover to make sure the impeller is not turning. When the rotor brakes, the symbol  described in the **Display** section is visible. Emergency opening of the cover during rotor spinning is not allowed.

Checking of excessive temperature

If temperature in rotation chamber exceeds 50°C caused by, for example, malfunction of cooling system, drive will be switched off and error message will be displayed. The reboot is only possible after chilling device.

7 Centrifuging

Power switching ON/OFF is carried out with master switch situated on the right-side wall of the centrifuge. All settings on the centrifuge are done by means of the control panel.

7.1 Control panel

The control panel placed on the front casing serves the purpose of controlling centrifuge operation.



Control panel

	SHORT ¹	short-time centrifuging
	START	start centrifugation run
	STOP ²	end centrifugation run
	COVER	cover opening
	FAST COOL	start fast cooling mode
	BACK RPM/RCF	exit the current menu / cancelling switching between SPEED display mode and RCF display mode
	UP	navigation in menu / increasing values
	DOWN	navigation in menu / decreasing values
	LEFT	navigation in menu
	RIGHT	navigation in menu
SET	SET	changing parameters / confirming changes

¹ the centrifuge is working as long as the key is pressed

² First-time pressing will make stopping centrifuging with acceleration characteristics set in the current program, second-time pressing will make braking as fast as possible.

7.2 Display

The display is located in the centre of the control panel. The main screen variants are presented below.

	<p>After switching on centrifuge, welcome screen appears. After disappearing the welcome screen, it is possible to setting up parameters.</p>
	<p>Simplified display mode is set as default, there is possible to switch to normal (see chapter 9.3) display mode (with two sub modes shown below).</p>

Normal display	
RPM display mode	RCF display mode







Switching between RPM and RCF display mode

For normal display switching between RPM and RCF display mode may be obtain by pressing and keeping key by 1s :

then one should choose demand mode.

SPEED	rotor speed	assigned/measured
RCF	centrifugal force	assigned/measured
TIME	centrifuging time	assigned/measured
TEMP	temperature	assigned/measured
PRG ---	program no.	
11199 / ---	rotor no.	
PARA	parameters of the centrifuge	
MENU	configuration menu	

	changing values		
	density > 1,2 g/cm ³		
	centrifuging radius changed		
	counting time down (decreasing)		counting time up (increasing)
	centrifuging		centrifuging (with automatic cover opening)
	rotor stopped / closed cover		rotor stopped / opened lid
	braking		fastest decelerating
	rotor identification		
	thermal chamber		
	temperature delay		
	time delay		











	currently enlarged digits of TIME field		
	drop-down list		
	temporarily disabled		
	locked		
	time counting (blinking)		
	disabled option		active option

7.3 Setting up RPM, RCF, time, temperature











On the main screen, it is possible to set:

rotating speed - RPM	SPEED
relative centrifugal force (multiple of g-force)	RCF
centrifuging time	TIME
centrifuging temperature	TEMP

Exemplary change of **SPEED** setting:

	<ul style="list-style-type: none"> Press SET (to enter edit mode) –  appears. Via     keys mark SPEED field (highlighted). Press SET –  blinking. With   choose demanded value. Via   choose order of magnitude of changing value (highlighted). Repeat above two steps for other orders of magnitude. Confirm settings by pressing SET. Press BACK.
<p>When RPM is changed, RCF is automatically corrected.</p>	

Exemplary change of **RCF** setting:

	<ul style="list-style-type: none"> Press SET (to enter edit mode) –  appears. Via     keys mark RCF field (highlighted). Press SET –  blinking. With   choose demanded value. Via   choose order of magnitude of changing value (highlighted). Repeat above two steps for other orders of magnitude. Confirm settings by pressing SET. Press BACK.
<p>When RCF is changed, RPM is automatically corrected.</p>	

Switching between SPEED and RCF.



On the screen appear an additional window, in which:

- Via ▲▼ keys mark field .
- Press **SET**.

Change of screen mode will be active to switch off the centrifuge

Switching between basic and simplified screens is described in **Main screen modes**.

Exemplary change of **TIME** setting:



- Press **SET** (to enter edit mode) - appears.
- Via ▲▼◀▶ keys mark **TIME** field (highlighted).

00:02:00
[hh : mm : ss]

e.g.:

centrifuging time – 2 minutes 00
seconds

- Press **SET** blinking.
- With ▲▼ choose demanded value.
- Via ◀▶ choose order of magnitude of changing value (highlighted).
- Repeat above two steps for other orders of magnitude.
- Confirm settings by pressing **SET**.
- Exit edit mode by pressing **BACK**.

00:02:00

set value

02:00

current value (most significant digits)

HOLD mode

continuous run mode

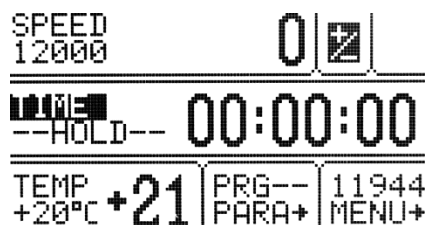

- To run centrifuging in **HOLD** mode set **00:00:00** time.
- To end centrifuging in **HOLD** mode press **STOP**.

Exemplary change of **TEMP** setting:



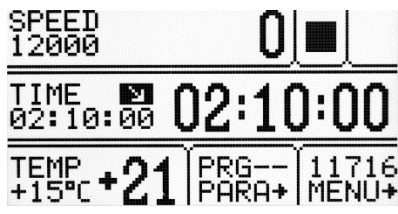

- Press **SET** (to enter edit mode) - appears.
- Via ▲▼◀▶ keys mark **TEMP** field (highlighted).
- Press **SET** key.
- With ▲▼ choose demanded value.
- Confirm settings by pressing **SET**.
- Press **BACK**.

7.4 Users programs

	<p>After switching centrifuge on, program that was used in previous session is being loaded. If any program was not used in previous session, centrifuge resume the last chosen parameters.</p>
-----------------------------------------------------------------------------------	-------------------------------------------------------------------------------------------------------------------------------------------------------------------------------------------------

Program choosing:

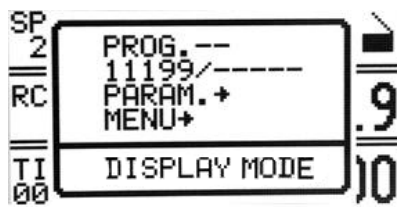
Simplified display mode

	<ul style="list-style-type: none"> ▪ Press and hold  by 1 second. ▪ Choose PROG with ▲▼ ▪ Press SET. ▪ Execute points described follow (below Normal display mode description)
-----------------------------------------------------------------------------------	-------------------------------------------------------------------------------------------------------------------------------------------------------------------------------------------------------------------------------------------------------------------------------------------------------------------

Normal display mode

	<ul style="list-style-type: none"> ▪ Press SET key –  appears. ▪ Via ▲▼◀▶ keys mark PRG-- field (highlighted) ▪ Press SET key – list of programs is visible.
------------------------------------------------------------------------------------	--------------------------------------------------------------------------------------------------------------------------------------------------------------------------------------------------------------------------------------------------------------------------------

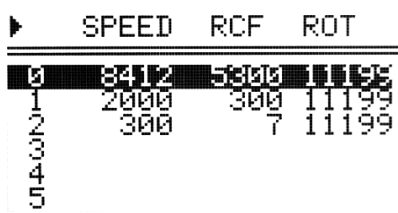
	<ul style="list-style-type: none"> ▪ Via ▲▼ choose demanded program. ▪ Confirm with SET key.
-------------------------------------------------------------------------------------	----------------------------------------------------------------------------------------------------------------------

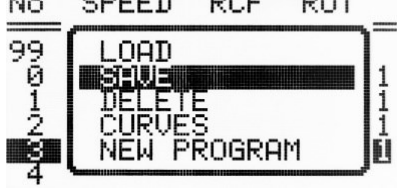
	<p>LOAD, SAVE, DELETE, CURVES, NEW PROGRAM refer chosen program which is marked by ▶.</p>
-------------------------------------------------------------------------------------	--------------------------------------------------------------------------------------------------

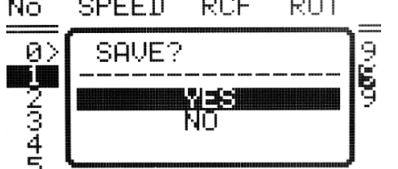
	<p>SAVE – save settings as a program (confirm by selecting YES and pressing SET)</p>
-------------------------------------------------------------------------------------	---------------------------------------------------------------------------------------------

	<p>DELETE – delete program (confirm by selecting YES and pressing SET)</p>
-------------------------------------------------------------------------------------	-----------------------------------------------------------------------------------

NEW PROGRAM– enter to create new program mode (as below)

NEW PROGRAM – enter to create new program mode (as below)

Creating a new program:

<p>SPEED 2000 0 [PRG]</p> <p>TIME 00:02:00 00:02:00</p> <p>TEMP +20°C +21 [PRG] 11199</p> <p>No SPEED RCF ROT</p> <table border="1"> <tr><td>0</td><td>8412</td><td>5300</td><td>11199</td></tr> <tr><td>1</td><td>2000</td><td>300</td><td>11199</td></tr> <tr><td>2</td><td>300</td><td>7</td><td>11199</td></tr> <tr><td>3</td><td></td><td></td><td></td></tr> <tr><td>4</td><td></td><td></td><td></td></tr> </table> <table border="1"> <tr><td>No</td><td>SPEED</td><td>RCF</td><td>ROT</td></tr> <tr><td>99</td><td>LOAD</td><td></td><td></td></tr> <tr><td>0</td><td>SAVE</td><td></td><td>1</td></tr> <tr><td>1</td><td>DELETE</td><td></td><td>1</td></tr> <tr><td>2</td><td>CURVES</td><td></td><td>1</td></tr> <tr><td>3</td><td>NEW PROGRAM</td><td></td><td>1</td></tr> <tr><td>4</td><td></td><td></td><td></td></tr> </table>	0	8412	5300	11199	1	2000	300	11199	2	300	7	11199	3				4				No	SPEED	RCF	ROT	99	LOAD			0	SAVE		1	1	DELETE		1	2	CURVES		1	3	NEW PROGRAM		1	4				<ul style="list-style-type: none"> ▪ Press SET key. ▪ Via ▲▼◀▶ keys mark PRG -- field (blinking). ▪ Press SET key. List of programs is visible, choose demanded position (number of program). ▪ Press SET key- menu of program settings will appear. ▪ Choose NEW PROGRAM press SET and BACK, and then set demanded parameters of centrifuging (look chapter “6. Centrifuging”). ▪ In case you want to register new program, back to the PRG -- menu and save it as described before.
0	8412	5300	11199																																														
1	2000	300	11199																																														
2	300	7	11199																																														
3																																																	
4																																																	
No	SPEED	RCF	ROT																																														
99	LOAD																																																
0	SAVE		1																																														
1	DELETE		1																																														
2	CURVES		1																																														
3	NEW PROGRAM		1																																														
4																																																	









Changing parameters during centrifuging



There is a possibility to change parameters: **SPEED, RCF, TIME, and TEMP** during centrifuging. Such modifications inactivate currently running program. Modification during run is represented by **PRG --** symbol (instead of the program number).



7.5 Creator of acceleration and deceleration curves

<p>No SPEED RCF ROT</p> <table border="1"> <tr><td>0</td><td>8412</td><td>5300</td><td>11199</td></tr> <tr><td>1</td><td>2000</td><td>300</td><td>11199</td></tr> <tr><td>2</td><td>300</td><td>7</td><td>11199</td></tr> <tr><td>3</td><td></td><td></td><td></td></tr> <tr><td>4</td><td></td><td></td><td></td></tr> <tr><td>5</td><td></td><td></td><td></td></tr> </table> <table border="1"> <tr><td>No</td><td>SPEED</td><td>RCF</td><td>ROT</td></tr> <tr><td>0</td><td>LOAD</td><td></td><td>1</td></tr> <tr><td>1</td><td>SAVE</td><td></td><td>1</td></tr> <tr><td>2</td><td>DELETE</td><td></td><td>1</td></tr> <tr><td>3</td><td>CURVES</td><td></td><td>1</td></tr> <tr><td>4</td><td>NEW PROGRAM</td><td></td><td>1</td></tr> <tr><td>5</td><td></td><td></td><td></td></tr> </table> <table border="1"> <tr><td>No</td><td>SPEED</td><td>RCF</td><td>ROT</td></tr> <tr><td>0</td><td>PROGRAM: 3</td><td></td><td>1</td></tr> <tr><td>1</td><td>---</td><td></td><td>1</td></tr> <tr><td>2</td><td>---</td><td></td><td>1</td></tr> <tr><td>3</td><td>ACCELERATION</td><td></td><td>1</td></tr> <tr><td>4</td><td>DECELERATION</td><td></td><td>1</td></tr> <tr><td>5</td><td></td><td></td><td></td></tr> </table>	0	8412	5300	11199	1	2000	300	11199	2	300	7	11199	3				4				5				No	SPEED	RCF	ROT	0	LOAD		1	1	SAVE		1	2	DELETE		1	3	CURVES		1	4	NEW PROGRAM		1	5				No	SPEED	RCF	ROT	0	PROGRAM: 3		1	1	---		1	2	---		1	3	ACCELERATION		1	4	DECELERATION		1	5				<p style="text-align: right;">PROG/CURVES</p> <ul style="list-style-type: none"> ▪ With ▲▼ keys choose saved program for which you intend to create the acceleration or deceleration characteristics (marked with symbol ▶). ▪ Press SET. ▪ With ▲▼ keys choose CURVES. ▪ Press SET - the selection frame is displayed. <ul style="list-style-type: none"> ▪ With ▲▼ keys choose ACCELERATION to create acceleration characteristics or DECELERATION to create deceleration characteristics ▪ Confirm selection by pressing SET.
0	8412	5300	11199																																																																														
1	2000	300	11199																																																																														
2	300	7	11199																																																																														
3																																																																																	
4																																																																																	
5																																																																																	
No	SPEED	RCF	ROT																																																																														
0	LOAD		1																																																																														
1	SAVE		1																																																																														
2	DELETE		1																																																																														
3	CURVES		1																																																																														
4	NEW PROGRAM		1																																																																														
5																																																																																	
No	SPEED	RCF	ROT																																																																														
0	PROGRAM: 3		1																																																																														
1	---		1																																																																														
2	---		1																																																																														
3	ACCELERATION		1																																																																														
4	DECELERATION		1																																																																														
5																																																																																	

7.5.1 Acceleration characteristic, creation of episode 1

<p>Displayed alternately SPEED and 3000 (example):</p>  	No	section no. (max. 4)
	TIME	total acceleration time
	SPEED	final RPM
	ACC	characteristic's no. (10-19)
		adding a new section
		deleting last section
		editing sections
		exiting from characteristics wizard
		switching RPM/RCF
	entering graph view	

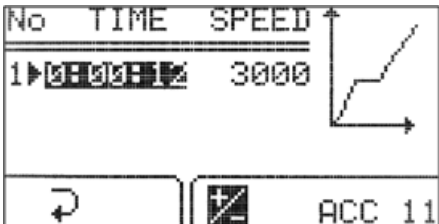
After entering the curve wizard, the symbol  is highlighted. Pressing **SET** and selecting "**NO**" in response to the question "**SAVE?**" will return to the **PROG → CURVES** menu without making changes to the starting characteristics. To start editing the one-segment characteristics, select the icon  with the **◀▶** keys and press the **SET** key.

		editing value (flashing means editing the given value)
	<ul style="list-style-type: none"> ▪ Press SET ▪ With ▲▼◀▶ choose time for section ▪ Press SET ▪ It is not possible to edit the maximum speed value. To do this, more sections have to be created, but the last section will always have the maximum set speed and cannot be changed. ▪ Select  with ▼◀ buttons and press SET to finish editing characteristics. 	

7.5.2 Adding and editing sections - acceleration

To program next sections, select the  icon with the **◀▶** buttons and press **SET**. A new section (sections) will appear with a time of 1 second and a speed equal to the maximum speed.

To start editing a newly added section (sections), select the  icon with the **◀▶** buttons and press **SET**, and follow the instructions given below.

After entering the profile section editing menu, the time value of the first section will be highlighted (see the picture below).

	<p>The maximum speed value for the section cannot be higher than the maximum speed value for the characteristic (for the last section).</p>
<ul style="list-style-type: none"> ▪ With ▲▼◀▶ highlight time or speed for desired section ▪ Press SET ▪ With ▲▼◀▶ choose value ▪ Press SET ▪ Repeat until setting all the sections ▪ To finish editing characteristic with ▲▼◀▶ choose ↻ and press SET. Finishing edition can be also done by pressing BACK button. 	

Saving created characteristic

	<ul style="list-style-type: none"> ▪ Select the ↻ icon with the ◀▶ buttons and press SET ▪ In the "Save?" window, use ▲▼ buttons to select YES to confirm saving the characteristic or NO, to exit without saving ▪ Press SET
--	------------------------------------------------------------------------------------------------------------------------------------------------------------------------------------------------------------------------------------------------------------------------------





7.5.3 Acceleration graph



An example of given parameters and a diagram:

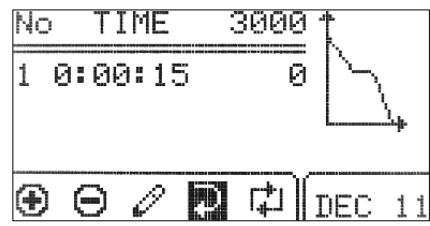

	<p>After the time value programming is completed, the TIME + SPEED segment of the user's startup characteristic can be displayed graphically. The set section of the characteristic curve is illustrated on the graph, which can be displayed by selecting the icon  with the ◀▶ keys and pressing the SET key.</p>
--	----------------------------------------------------------------------------------------------------------------------------------------------------------------------------------------------------------------------------------------------------------------------------------------------------------------------------------------------------------------------------------------------------------------------

7.5.4 Deceleration characteristic, creation of episode 1

<p>SPEED or 3000 displayed (example):</p>	<table border="1"> <tr> <td data-bbox="676 1691 813 1742">No</td> <td data-bbox="826 1691 1414 1742">section no. (max. 4)</td> </tr> <tr> <td data-bbox="676 1753 813 1805">TIME</td> <td data-bbox="826 1753 1414 1805">total acceleration time</td> </tr> <tr> <td data-bbox="676 1816 813 1868">SPEED</td> <td data-bbox="826 1816 1414 1868">final RPM</td> </tr> <tr> <td data-bbox="676 1879 813 1930">DEC</td> <td data-bbox="826 1879 1414 1930">characteristic's no. (10-19)</td> </tr> <tr> <td data-bbox="676 1942 813 1993">+</td> <td data-bbox="826 1942 1414 1993">adding a new section</td> </tr> <tr> <td data-bbox="676 2004 813 2056">-</td> <td data-bbox="826 2004 1414 2056">deleting last section</td> </tr> </table>	No	section no. (max. 4)	TIME	total acceleration time	SPEED	final RPM	DEC	characteristic's no. (10-19)	+	adding a new section	-	deleting last section
No	section no. (max. 4)												
TIME	total acceleration time												
SPEED	final RPM												
DEC	characteristic's no. (10-19)												
+	adding a new section												
-	deleting last section												

		editing sections
		exiting from characteristics menu
		switching RPM/RCF
		entering graph view

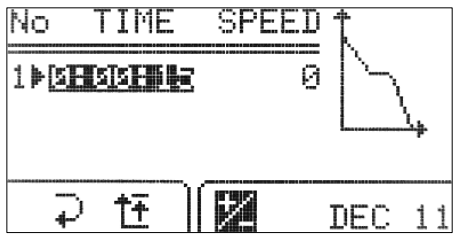
After entering the curve wizard, the symbol  is highlighted. Pressing **SET** and selecting "NO" in response to the question "SAVE?" will return to the **PROG → CURVES** menu without making changes to the starting characteristics. To start editing the one-segment characteristics, select the icon  with the **◀▶** keys and press the **SET** key.



		editing value (flashing means editing the given value)
	<ul style="list-style-type: none"> ▪ Press SET ▪ With ▲▼◀▶ choose time for section ▪ Press SET ▪ To edit speed ▪ It is not possible to edit the minimum speed value. To do this, more legends must be created, but the last leg will always be "0". ▪ Select  with ▼◀ buttons and press SET to finish editing characteristics 	

7.5.5 Adding and editing sections - deceleration

In order to program successive periods, select the icon  with the **◀▶** keys and press the **SET** key. A new segment (or segments - after successive presses of SET) will appear with the time and speed equal to the minimum speed - "0".

To start editing the newly added sections, select the icon  with the **◀▶** buttons, press **SET** and make the settings as described below.

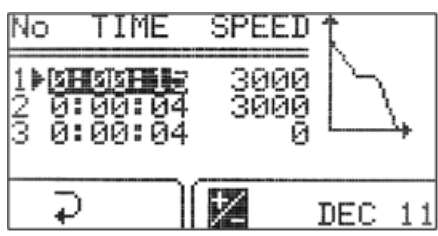
After entering the profile section editing menu, the time value of the first section will be highlighted (see the picture below).

	The speed value of the last segment will always be "0".	
	<ul style="list-style-type: none"> ▪ With ▲▼◀▶ highlight time or speed for desired section ▪ Press SET ▪ With ▲▼◀▶ choose value ▪ Press SET ▪ Repeat until setting all the sections ▪ To finish editing characteristic with ▲▼◀▶ choose  and press SET. Finishing edition can be also done by pressing BACK button 	

SAVING CREATED CHARACTERISTIC

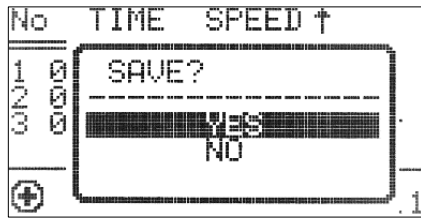

- Select the  icon with the **◀▶** buttons and press **SET**
- In the "Save?" window, use **▲▼** buttons to select YES to confirm saving the characteristic or NO, to exit without saving
- Press **SET**

7.5.6 Deceleration graph

An example of given parameters and a diagram:

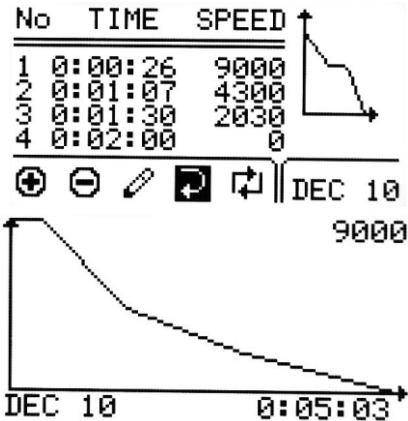

After programming the time value, you can graphically display the **TIME + SPEED** segment of the user's braking characteristic. The set section of the characteristic curve is illustrated on the graph, which can be displayed by selecting

the icon  with the **◀▶** keys and pressing the **SET** key.

7.5.7 Deleting sections

In the characteristic's wizard:



- Select the  icon with the **◀▶** buttons and press **SET**
- In the "Delete?" window, use **▲▼** buttons to select YES to confirm deleting the characteristic section or NO to cancel
- Press **SET**

7.6 Programs with user characteristics

Loading a modified program in the **CURVES** fold is signaled by the icon on the main screen:

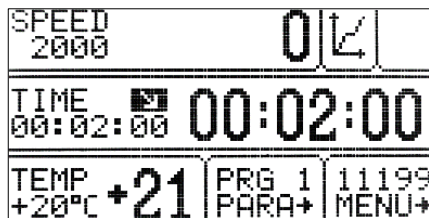



Icon  signals that program with user acceleration/deceleration characteristics are loaded.

A change in any parameter entails the deactivation of the multi-section's curves mode.

7.7 Rotor and bucket choosing

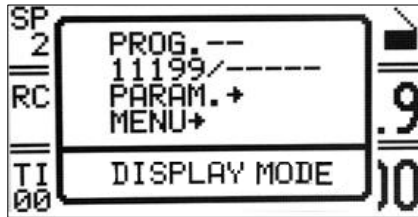
Simplified display mode



- Press and hold  by 1 second.
- Choose rotor number (exemplary **11199/-----**) with ▲▼.
- Press **SET**.
- Execute points described follow (below **Normal display mode** description)

Normal display mode

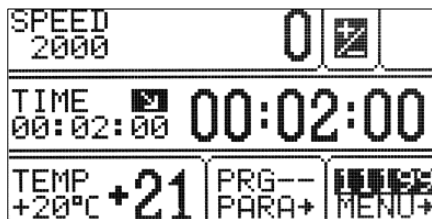

- Press **SET**— appears.
- Via ▲▼◀▶ mark rotor choosing field.
- Press **SET** (Rotors and buckets list will appear).

ROTOR	BUCKET	SPEED
>11199	-----	15000
11461	-----	15000
11716	-----	15000
11760	-----	14000
11942	-----	6000
11943	-----	15000

- Via ▲▼ keys mark demanded rotor number
- Confirm by pressing **SET**.
- If a bucket can be selected:
 - With ▲▼ select demanded bucket number.
 - Press **SET**.
- Press **BACK** to close edition mode.

RCF	RMAX	RMIN
>16854	87	40
20879	83	40
17608	70	40
20160	92	40
3542	88	50
21382	85	51

- With ◀▶ keys one may switch between screens of rotors parameters

- It is possible to set **AUTOMATIC ROTOR IDENTIFICATION**. The procedure is described in subsection "Other".

7.8 SHORT mode

SHORT MODE – short work mode (centrifuging with pressed **SHORT** key)



- The **SHORT** mode is activated by pressing and holding **▶▶(SHORT)**. In **SHORT** mode the centrifuge is working as long as the **SHORT** key is pressed or when set time is over.
- Centrifuging is stopped after releasing the **SHORT** key.

7.9 Finishing the centrifuging

- When preselected time is reached, centrifugation will end automatically.

SPEED 2000 0

TIM 00: CYCLE FINISHED 15

TEMP +5°C +15 PRG-- 11716
PARA+ MENU+



x1

- Before lapsing preselected time, one may stop centrifugation. Pressing **STOP** for the first time will stop centrifuging with the characteristic set-in loaded program.



symbol will be shown.



x2

- Pressing **STOP** second time will stop centrifuging with the fastest characteristic.



symbol will be shown.

SPEED 2000 0

TIM 00: CYCLE INTERRUPTED ! 00

TEMP +5°C +15 PRG-- 11716
PARA+ MENU+

- The message about cancel of centrifuging can be delete with the **STOP, SET, COVER, ▲▼◀▶** or **BACK** key.

8 Temperature control

Centrifuge is equipped with ecological refrigerating system with temperature control. During centrifugation, there may appear differences in temperature on the display and temperature of the samples in the rotor. It depends on thermal conductivity of the rotor, and samples, centrifugation time, initial temperature of rotor and samples



Exemplary change of **TEMP** setting:

SPEED 2000 0

TIME 00:02:00 00:02:00



TEMP +21 PRG-- 11199
PARA+ MENU+

- Press **SET** (to enter edit mode) –  appears.
- Via **▲▼◀▶** keys mark **TEMP** field (highlated).
- Press **SET**.
- Via **▲▼** set value.
- Confirm via **SET** key.

	 <p>When chamber is being cooled,  symbol is visible on the screen (blinking).</p>
-----------------------------------------------------------------------------------	----------------------------------------------------------------------------------------------------------------------------------------------------------------------------------------------------------------------------------------------------------

8.1 Initial cooling during centrifuging - FAST COOL

	<ul style="list-style-type: none"> The parameters allowable to change at FAST COOL mode: <ul style="list-style-type: none"> temperature (lower than current temperature shown by centrifuge) In order to centrifuging reduced temperature samples (e.g., storage in the external refrigerator) centrifuge chamber, rotor and centrifuge container must be pre-cooling to the predetermined temperature. It causes minimalization of temperature differences. Initial cooling may be activated by FAST COOL key (lid must be closed – rotor is spinning at FAST COOL mode) When FAST COOL mode is active, cooling system automatically set proper parameters to obtain demanded temperature the fastest way. It is possible to exit FAST COOL mode at any time by pressing STOP key.
-----------------------------------------------------------------------------------	--------------------------------------------------------------------------------------------------------------------------------------------------------------------------------------------------------------------------------------------------------------------------------------------------------------------------------------------------------------------------------------------------------------------------------------------------------------------------------------------------------------------------------------------------------------------------------------------------------------------------------------------------------------------------------------------------------------------------------------------------------------------------------------------------------------------------------------------------------------------------------------------------

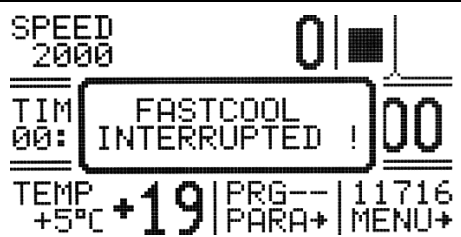
	<p>FAST COOL mode is marked by symbol  blinking in the right upper side of display.</p>
	<p>It is possible to exit FAST COOL mode at any time by pressing STOP key. Interruption of the function is signalled by a message.</p>

8.2 Initial cooling without centrifuging – THERMAL CHAMBER

	<p style="text-align: right;">PARA → THERMAL CHAMBER</p> <ul style="list-style-type: none"> There is possible to run centrifuge in THERMAL CHAMBER mode – cooling (rotor is at standstill). How to enable THERMAL CHAMBER is described in “Thermal chamber” chapter.
-------------------------------------------------------------------------------------	-------------------------------------------------------------------------------------------------------------------------------------------------------------------------------------------------------------------------------------------------------------------------------------------------------------------

8.3 Cooling in “START DELAY – OF TEMPERATURE” mode

	<p style="text-align: right;">PARA → START DELAY/OF TEMPERATURE</p> <ul style="list-style-type: none"> Centrifuging process will start, when preselected temperature is reached. How to enable run START DELAY – OF TEMPERATURE function is described in “Start delay – of temperature” chapter.
-------------------------------------------------------------------------------------	----------------------------------------------------------------------------------------------------------------------------------------------------------------------------------------------------------------------------------------------------------------------------------------------------------------------------------------

8.4 Cooling in „SHORT” mode





	<ul style="list-style-type: none"> ▪ Cooling feature is available in SHORT mode. ▪ How to enable run centrifugation in SHORT mode is described in “SHORT mode”.
-----------------------------------------------------------------------------------	------------------------------------------------------------------------------------------------------------------------------------------------------------------------------------------------

8.5 Cooling notes

MPW-150R centrifuge is equipped with an efficient cooling system. It allows obtaining selected temperatures in the chamber even at maximum spin speed or fast obtaining desired temperatures (e.g., +4°C). Note that time and possibility of obtaining a set temperature is dependent on multiple factors, including: the power of the cooling system, the shape of the rotor, the rotor speed, ambient temperature, etc. The accuracy of the temperature stability of $\pm 1^\circ\text{C}$ is determined by the installation place of the temperature sensor.

9 Parameters of centrifugation

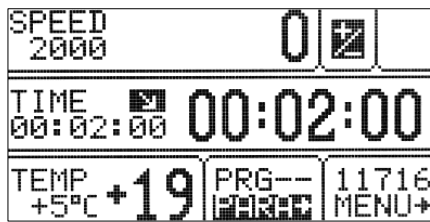
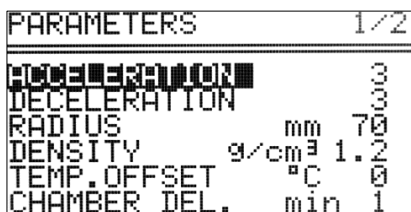



This chapter contains exemplary screens of MPW-260R centrifuge (screens for MPW-260 – without cooling – do not include temperature field).

Simplified display	
	<ul style="list-style-type: none"> ▪ Press and hold  by 1 second. ▪ Choose PARAM. with \blacktriangle \blacktriangledown ▪ Press SET.
Normal display	
	<ul style="list-style-type: none"> ▪ Press SET. ▪ With \blacktriangle \blacktriangledown \blacktriangleleft \blacktriangleright keys select PARAM. ▪ Press SET.
<ul style="list-style-type: none"> ▪ It is possible to switch between two different screens via \blacktriangleleft \blacktriangleright \blacktriangle \blacktriangledown keys in PARAMETERS field. 	
	
ACCELERATION	chosen acc. characteristic (0-the fastest, 9-the slowest)
DECELERATION	chosen dec. characteristic (0-the fastest, 9-the slowest)
RADIUS [mm]	current rotor radius [mm]
DENSITY (g/cm³)	sample density [g/cm ³]
TEMP. OFFSET (°C)	value of temperature correction
CHAMBER DEL. (min)	delay between set thermal chamber mode and start it
THERMAL CHAMBER	cooling of the chamber without centrifuging
AUTOM. LID OPENING	opening cover after centrifuging automatically
START DELAY	starting delayed (after pressing START)



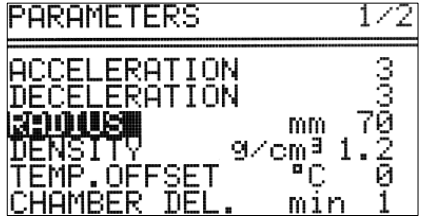
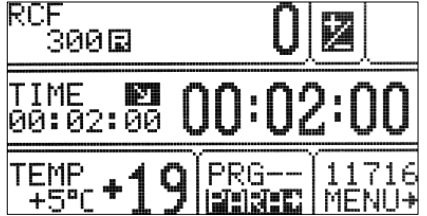

9.1 Acceleration/deceleration – changing characteristics

 <p>PARAMETERS 1/2</p> <p>ACCELERATION 3</p> <p>DECELERATION 3</p> <p>RADIUS mm 70</p> <p>DENSITY g/cm³ 1.2</p> <p>TEMP.OFFSET °C 0</p> <p>CHAMBER DEL. min 1</p>	<ul style="list-style-type: none"> With ▲▼ keys select ACCELERATION or DECELERATION. Press SET. With ▲▼ keys select demanded number of characteristics. Press SET. <p>ACCELERATION –10 (0 ÷ 9), linear accelerating characteristics assigned to every rotor. 0-the fastest acceleration, 9-the slowest acceleration.</p> <p>DECELERATION – 10 (0 ÷ 9), linear decelerating characteristics assigned to every rotor. 0-the fastest deceleration, 9-the slowest deceleration.</p>
---------------------------------------------------------------------------------------------------------------------------------------------------------------------------------------------------------------------------------------------------------------	---------------------------------------------------------------------------------------------------------------------------------------------------------------------------------------------------------------------------------------------------------------------------------------------------------------------------------------------------------------------------------------------------------------------------------------------------------------------------------------------------------------------------------------------------------------------



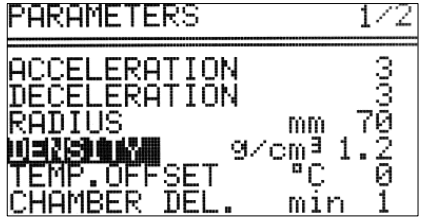

9.2 Radius

 <p>PARAMETERS 1/2</p> <p>ACCELERATION 3</p> <p>DECELERATION 3</p> <p>RADIUS mm 70</p> <p>DENSITY g/cm³ 1.2</p> <p>TEMP.OFFSET °C 0</p> <p>CHAMBER DEL. min 1</p>	<p>RADIUS [mm] - control of the radius of the rotor within the range from R_{min} to R_{max}. Available values depend on chosen rotor. Radius corrections serve for more precise control RCF, exemplary when user need to know real RCF in half length of test tube.</p> <ul style="list-style-type: none"> To change the rotor radius, select RADIUS [mm] with ▲▼ keys. Press SET. Set demanded value by pressing ▲▼. Press SET.
 <p>RCF 3000 0 </p> <p>TIME  00:02:00</p> <p>TEMP +5°C +19 PRG-- 11716</p> <p>+5°C +19  MENU+</p>	<p>When radius correction is activated,  symbol is visible on the screen.</p> <p>Reducing of the rotor radius resulting change of displayed RCF value.</p>

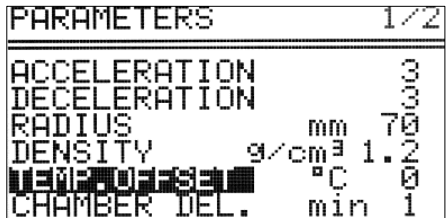

9.3 Sample density

 <p>PARAMETERS 1/2</p> <p>ACCELERATION 3</p> <p>DECELERATION 3</p> <p>RADIUS mm 70</p> <p>DENSITY g/cm³ 1.2</p> <p>TEMP.OFFSET °C 0</p> <p>CHAMBER DEL. min 1</p>	<p>DENSITY (g/cm³) – default density is set to 1,2 g/cm³</p> <p>To change the density (possible values 1,2÷9,9 g/cm³):</p> <ul style="list-style-type: none"> Via ▲▼ keys select DENSITY (g/cm³) Press SET. Set demanded value by pressing ▲▼. Press SET.
 <p>SPEED 2000 0 </p> <p>TIME  00:02:00</p> <p>TEMP +5°C +19 PRG-- 11716</p> <p>+5°C +19 PARA+ MENU+</p>	<p>When density is changed,  symbol is visible on the screen.</p> <p>Changing of DENSITY value is obligatory when density of sample placed into rotor is higher than 1.2 g/cm³. Change of DENSITY value led to decreasing maximum value of accessible speed.</p>

9.4 Temperature offset

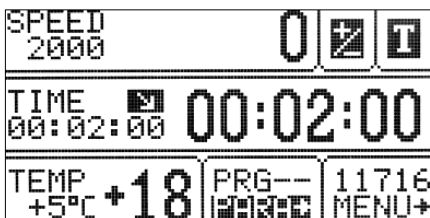

 <pre> PARAMETERS 1/2 ACCELERATION 3 DECELERATION 3 RADIUS mm 70 DENSITY g/cm³ 1.2 TEMP OFFSET °C 0 CHAMBER DEL. min 1 </pre>	<p>Temperature offsets serve for more precise control of real sample temperature. It can be helpful in case high/low initial temperature samples or high-volume samples.</p> <ul style="list-style-type: none"> With ▲▼ keys select TEMP. OFFSET. Press SET. Use the ▲▼ keys to select the difference between the temperature that the cooling system will aim for and set temperature. Confirm selection by pressing SET. <p>Attention! The use of the offset cannot extend the temperature range achieved by the centrifuge.</p> <p>Function description</p> <p>At a set temperature of 20°C and the set offset value equal to -5°C, cooling system will actually strive to reach 15°C. With a setpoint temperature of 20°C and a set offset value of 5°C the system will actually try to reach 25°C.</p> <p>The temperature displayed on the main screen is corrected for offset value.</p> <p>Offset can be selected range from -20°C to 20°C.</p>
 <pre> SPEED 2000 176 TIME 00:02:00 00 01 59 TEMP +5°C +21 PRG-- 11716 +5°C +21 PARA+ MENU+ </pre>	<p>Activation of the function is signaled on the main screen with  or  depending on the offset value sign.</p>

9.5 Thermal chamber

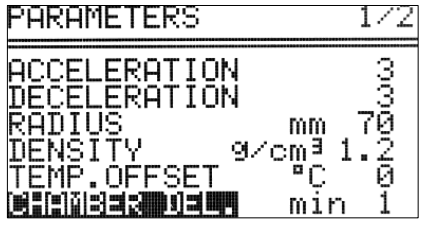

<p>Cooling without centrifuging.</p>	<p style="text-align: right;">THERMAL CHAMBER</p>
 <pre> PARAMETERS 2/2 THERMAL CHAMBER AUTOM. LID OPENING START DELAY </pre>	<ul style="list-style-type: none"> With ▲▼◀▶ keys select THERMAL CHAMBER. Press SET (to turn on/off). With ▲▼ keys select temperature value. Set demanded value (0°C÷40°C) by pressing ▲▼. Confirm selection by pressing SET. <p>Attention, in the centrifuge without heating, do not set the thermal chamber to a value higher than currently indicated by the centrifuge.</p>
 <pre> SPEED 2000 0 TIME 00:02:00 00:02:00 TEMP +5°C +18 PRG-- 11716 +5°C +18 PARA+ MENU+ </pre>	<p>When THERMAL CHAMBER function is activated,  symbol is visible on the screen.</p> <p>Changing temperature from the main screen is not possible.</p> <p>Opening cover terminates THERMAL CHAMBER function (closing cover back turns it on).</p>

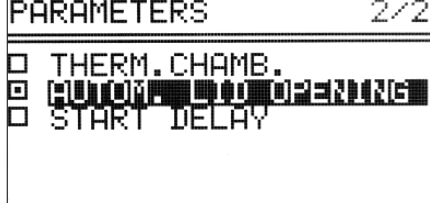
 <pre> PARAMETERS 1/2 ACCELERATION 3 DECELERATION 3 RADIUS mm 70 DENSITY g/cm³ 1.2 TEMP.OFFSET °C 0 CHAMBER DEL min 1 </pre>	<p>Thermal chamber is activated with delay.</p> <ul style="list-style-type: none"> Set time of delaying by select CHAMBER DEL. Press SET. With ▲▼ keys select demanded value (1-5 min). Press SET.
<ul style="list-style-type: none"> The function is activated automatically after confirmation and with the lid closed. The function is interrupted when the lid is opened, and the function resumes when the lid is closed again. If the THERMAL CHAMBER function is enabled during the centrifugation cycle, at the end of this cycle, the THERMAL CHAMBER function is activated until the lid is opened. Unlike other parameters, the THERMAL CHAMBER function can be turned on only when the centrifuge is stopped. 	

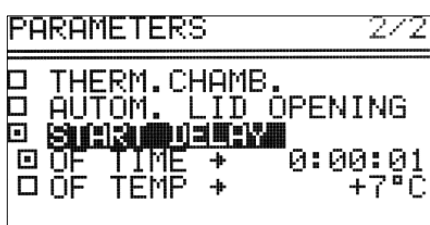

9.6 Automatic lid opening

<p>Automatic lid opening</p>	<p style="text-align: center;">AUTOMATIC LID OPENING</p>
 <pre> PARAMETERS 2/2 THERM. CHAMB. AUTOM. LID OPENING START DELAY </pre>	<ul style="list-style-type: none"> When centrifuge process is finished, cover will be opened automatically for set option AUTOM. LID OPENING. When centrifuging is terminated by pressing STOP, opening cover is possible by pressing COVER.
 <pre> SPEED 2000 647 TIME 00:02:00 00:01:57 TEMP +5°C +18 PRG-- 11716 +5°C PARA+ MENU+ </pre>	<p> symbol means that OPEN LID AFTER RUN is active.</p>

9.7 Start delay - of time

	<p>Start centrifuging since preselected delay is reached.</p>	<p style="text-align: center;">START DELAY / OF TIME</p>
 <pre> PARAMETERS 2/2 THERM. CHAMB. AUTOM. LID OPENING START DELAY OF TIME + 0:00:01 OF TEMP + +7°C </pre>	<ul style="list-style-type: none"> With ▲▼ keys select START DELAY. Press SET. Start delay can be set from 0:00:01 to 9:59:59. With ▲▼ keys select OF TIME. Press SET and ▶ and then SET. With ▲▼ keys set demanded value. Confirm by pressing SET. Press BACK to escape edit mode. 	
 <pre> SPEED 2000 0 TIME ---:---:--- 00:00:03 TEMP +5°C +17 PRG-- 11716 +5°C PARA+ MENU+ </pre>	<p>When START DELAY function is activated,  symbol is visible on the screen.</p>	
<ul style="list-style-type: none"> START DELAY / OF TIME function can be stopped at any moment by pressing STOP. START DELAY / OF TIME function cannot be run when START DELAY / OF TEMP is activated. 		

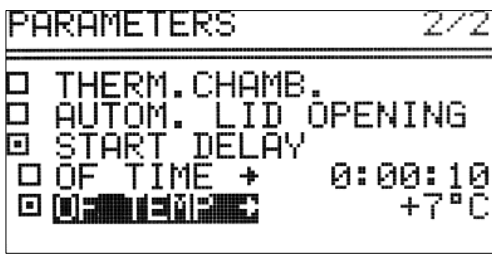
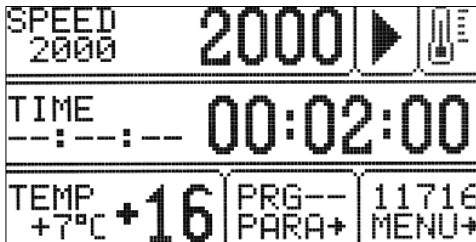
9.8 Start delay – of temperature

	Start centrifuging time counting since preselected temperature is reached.	START DELAY / OF TEMP.
		<ul style="list-style-type: none"> ▪ With ▲▼◀▶ keys mark START DELAY. ▪ Press SET. ▪ With ▲▼◀▶ keys mark OF TEMP. ▪ Press SET. ▪ Press ▶, press SET. ▪ With ▲▼ keys set demanded value of temperature. ▪ Press SET. ▪ Exit edit mode by press BACK.
		When START DELAY – OF TEMPERATURE is turned on,  symbol is visible on the screen.
<ul style="list-style-type: none"> ▪ When the function is active, the speed can be reduced to the optimum values for the FAST COOL function, when the set speed is lower than the optimum value, the rotor rotates at the set by user speed. 		
<ul style="list-style-type: none"> ▪ The delay starts - from the temperature can be interrupted at any time by pressing the STOP key. 		
<ul style="list-style-type: none"> ▪ START DELAY / OF TEMP. function cannot be run when START DELAY / OF TIME is activated. 		

9.9 Temporarily disabled functions

Functions written below can be temporarily disabled.

active	SPEED	RCF	TIME	TEMP	PROG —	— / —	PARAM	MENU
THERMAL CHAMBER	●	●	●	○	●	●	●	●

During the spin cycle

active	SPEED	RCF	TIME	TEMP	PROG —	— / —	PARAM	MENU
STANDARD SPIN	●	●	●	○	●	○	●	●
ACC/DEC 10-19	○	○	●	●	○	○	●	●

When setting parameters

active	SPEED	RCF	TIME	TEMP	PROG —	— / —	PARAM	MENU
STANDARD SPIN	○	○	○	○	●	○	○	●
ACC/DEC 10-19	○	○	●	●	●	○	●	●

- available
- disabled

9.10 Printing report (USB)

When the centrifuging process is finished there is a possibility to obtain report. Report can be transferred to PC or printed.

PC (USB)

The elements needed to make connecting your computer via USB:

name	quantity (pcs.)	cat. No.
USB A-A cable	1	16655
MPW Editor 2 application	1	to downloaded from the website: www.mpw.pl

Preparation

- Install **MPW Editor 2** application on the computer. Program is available for download from our website at www.mpw.pl.

Operating System Requirements: **Microsoft Windows 10 (64bit)**.

The Manufacturer does not guarantee that the program will work correctly with other operating systems.

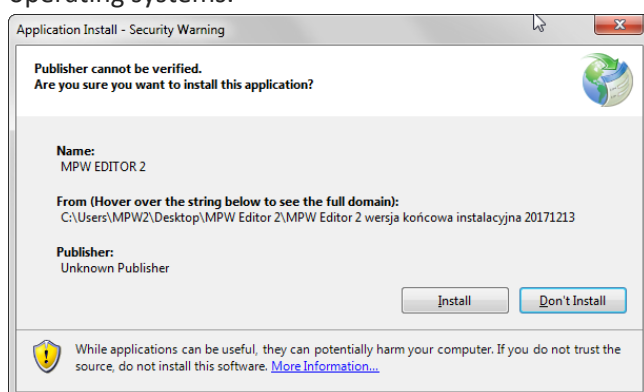

- If necessary install **FTDI USB drivers** and **.NET Framework 4.0** library (download with manufacturer's website: www.mpw.pl)

Centrifuging and printing

- Run **MPW Editor 2** application.
- Choose **Language\English**

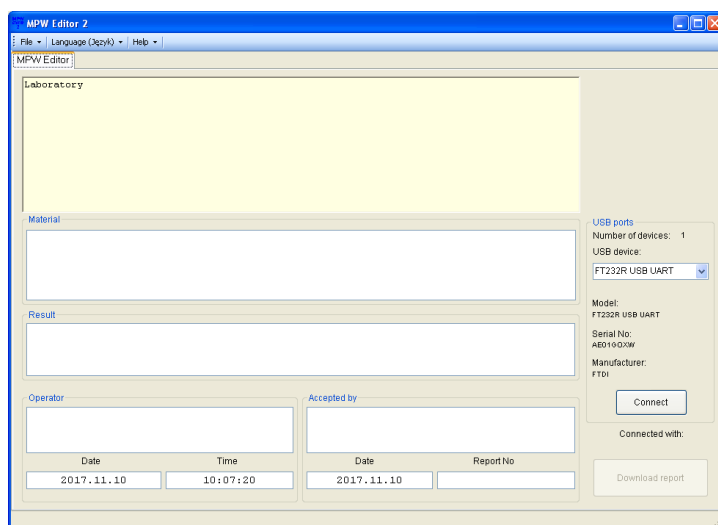

- Connect centrifuge to the PC in accordance with the „Connection scheme”
- Choose port assigned to the centrifuge (it will appear after connecting USB cable).

Attention:

If the interface has not been programmed: name, serial number and manufacturer's name, the device will be identified by Windows and MPW Editor 2 with the data programmed by FTDI (manufacturer USB integrated circuit) for example FT232R USB UART.

- Choose **File\Edit form**

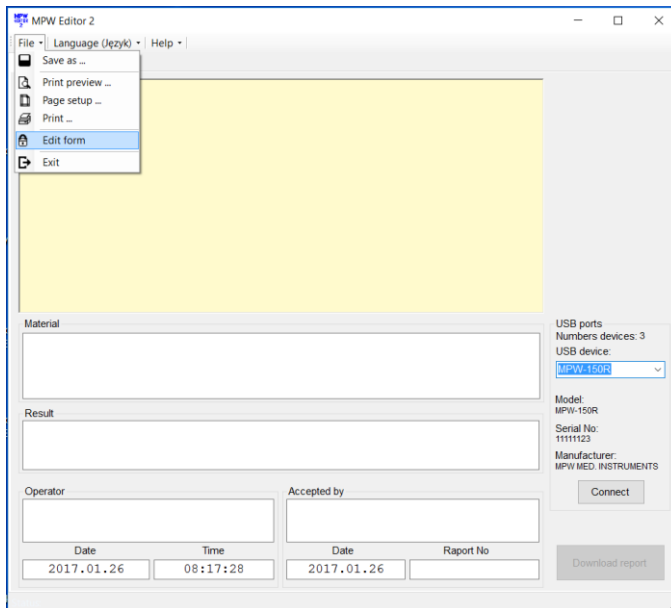

- In the „Tytuł (Title)” field, you can place any text, for example name of the laboratory, for later use in the report template.

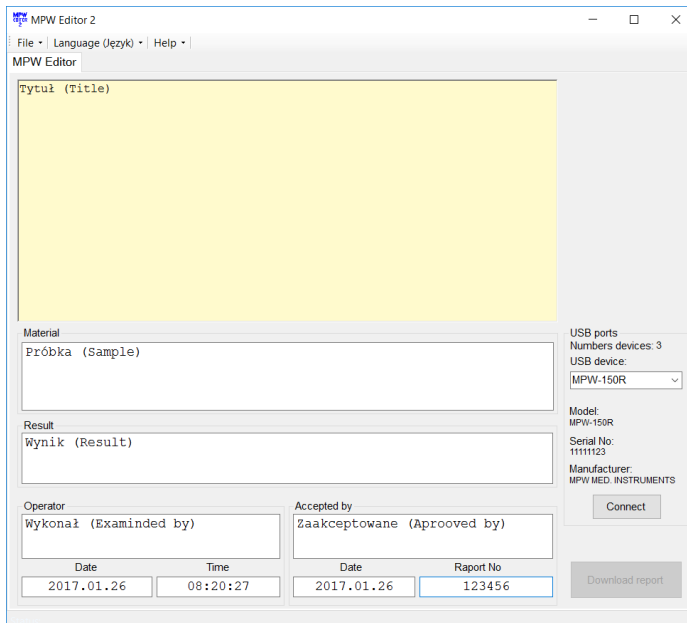

- Choose **File\Save form**.
- Ensure that USB device is selected from the list of devices.
- Press **Connect**. After successful communication, "PC" appears in the display.

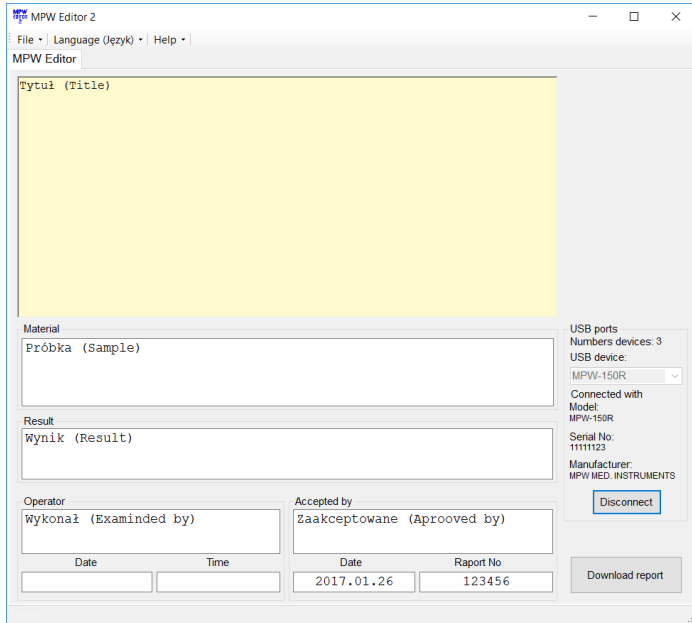



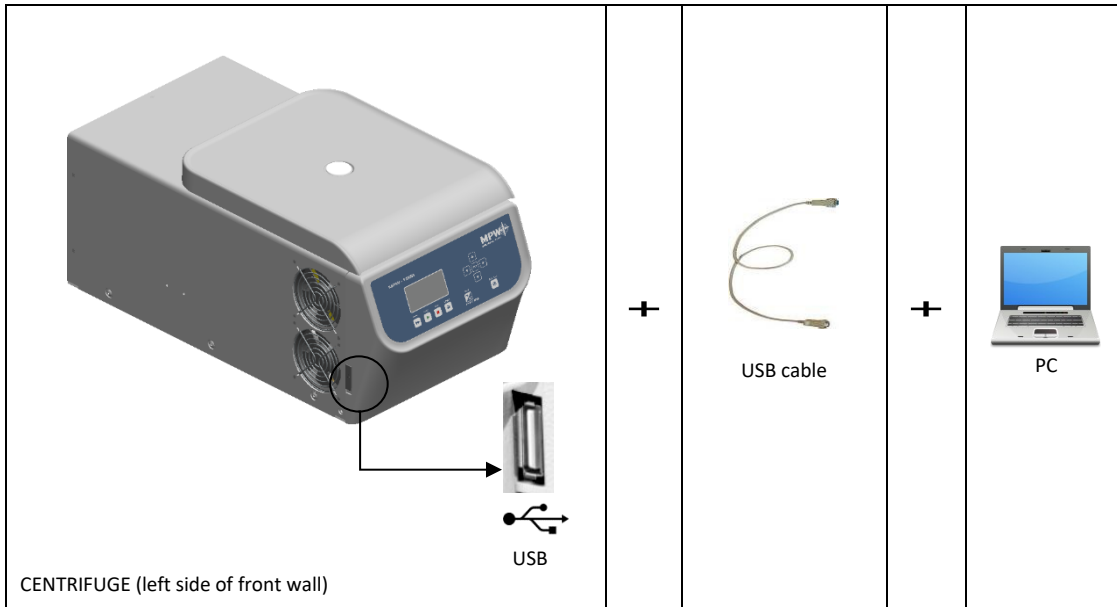

- Fill folds: „Material”, „Result”, „Operator”, „Accepted by”, „Report no” (optionally).
- When the centrifuging process is finished, press **Download the report**.
- When centrifuging process is completed, report will appear.
- Save report (**File/Save as**) or print it (**File/Print**).
- In order to get another report, press New test and press Download the report.
- After finishing the work, press **Disconnect** button (the "PC" disappears from the display of the centrifuge) and then closes MPW Editor 2.

Connection diagram

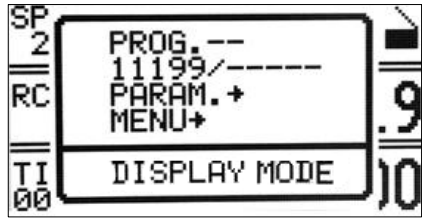

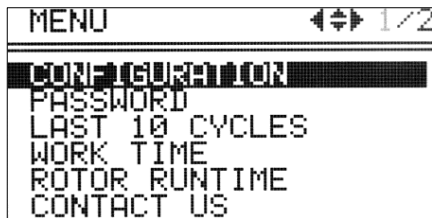
10 Menu

Simplified display	
	<ul style="list-style-type: none"> Press and hold  by 1 second. Choose MENU with ▲▼ Press SET. <p>Execute points described follow (below Normal display mode description)</p>
Normal display	
	<ul style="list-style-type: none"> Press SET. With ▲▼◀▶ keys select MENU. Press SET.
 	<ul style="list-style-type: none"> To navigate in MENU use ▲▼◀▶ keys. To enter menu press SET.
CONFIGURATION	centrifuge configuration
PASSWORD	password protection
LAST 10-CYCLES	10 last centrifugation cycles history
CYCLES	total working time of centrifuge, total number of working cycles
ROTOR RUNTIME	counting time of work and cycles amount for each rotor
CONTACT US	manufacturer's details
DIAGNOSTICS	error codes (service field)
FACTORY SETTINGS	restore factory settings

10.1 Screen saver

Setting time of screen saver	MENU/ CONFIGURATION / SCREEN
	<ul style="list-style-type: none"> With ▲▼◀▶ keys select SCREENSAVER. Press SET and then ▼ and SET. With ▲▼ keys select demanded value from 1 to 60 minutes. Mark selection by pressing SET. Leave the menu by pressing BACK.

10.2 Visual alarm

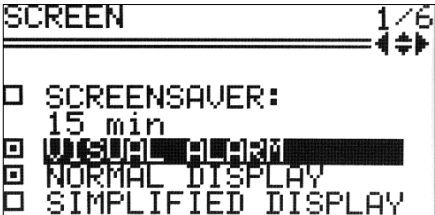
<p>Visual alarm</p> 	<p style="text-align: right;">MENU/CONFIGURATION/ SCREEN</p> <ul style="list-style-type: none"> Via ▲▼ keys choose VISUAL ALARM Mark it by pressing SET. <p>VISUAL ALARM cause blinking screen after ending of centrifuging or after message occurring.</p>
-------------------------------------------------------------------------------------------------------	----------------------------------------------------------------------------------------------------------------------------------------------------------------------------------------------------------------------------------------------------------------------------------------------------------

10.3 Types of main screen

To ensure optimal adaptation to the user's preferences, work is possible in two basic screen modes.

NORMAL DISPLAY - contains an expanded number of parameters visible on the display.

SIMPLIFIED DISPLAY - contains only the most important parameters visible on the display.

For each of the above modes, you can choose priority RPM display or RCF.

By default, the **SIMPLIFIED DISPLAY** is set

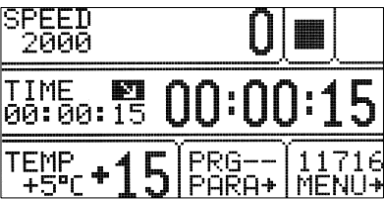
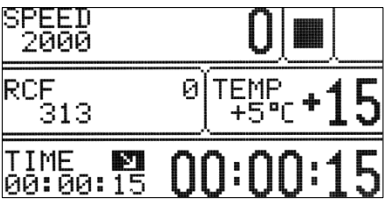
Types of main screen	
NORMAL DISPLAY	SIMPLIFIED DISPLAY
	
Switch between the SPEED (RPM) and RCF display priority modes	
<ul style="list-style-type: none"> In the NORMAL DISPLAY mode, selecting the SPEED or RCF display mode is obtained by pressing and holding BACK for 1 sec. then use the ▲▼ buttons to select the desired mode (SPEED or RCF) and press SET. 	<ul style="list-style-type: none"> In the SIMPLIFIED DISPLAY mode, the selection of the SPEED or RCF display mode is obtained by pressing and holding the BACK key for 1 second. then use ▲▼ keys to select DISPLAY MODE, press SET, and then use ▲▼ keys to select the desired mode (SPEED or RCF) and press SET.

10.3.1 Switching the normal display to simplified display

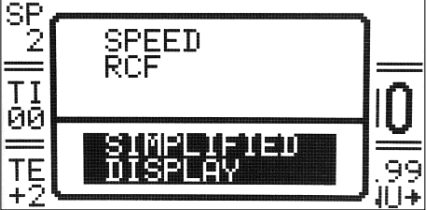
<i>Method I</i>	
	<ul style="list-style-type: none"> Press the BACK button for 1 sec. to return to the basic display (a short menu is displayed on the screen), then: Via ▲▼ keys select SIMPLIFIED DISPLAY. Press SET.

Method II

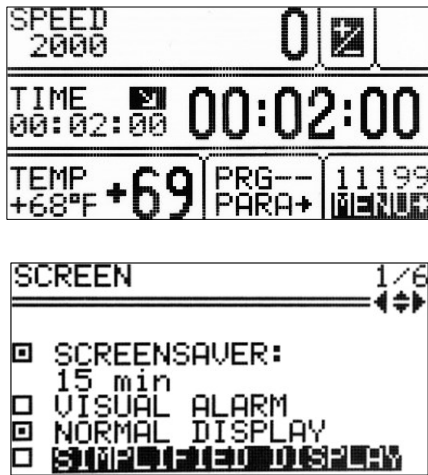

- Press SET –  appears.
- Via ▲▼◀▶ keys select **MENU**.
- Press SET.
- Via ▲▼ keys select **CONFIGURATION** tab.
- Press SET.
- Via ◀▶ keys select **SCREEN** tab.
- Via ▲▼ keys select **SIMPLIFIED DISPLAY**.
- Press SET.
- Leave menu via **BACK** key.

10.3.2 Switching the simplified screen to normal display

Method I

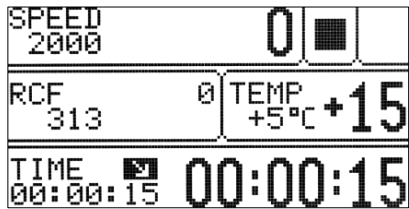

- Press the **BACK** button for **1 sec.**

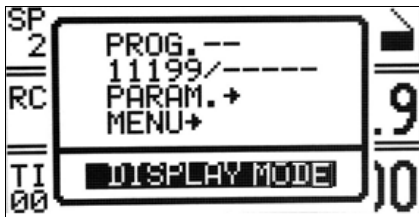

- Via ▲▼ keys select **DISPLAY MODE** (highlighted).
- Press SET.

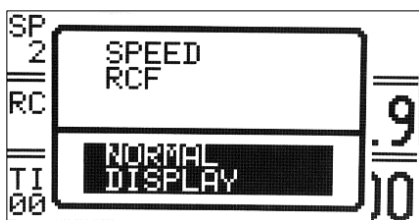

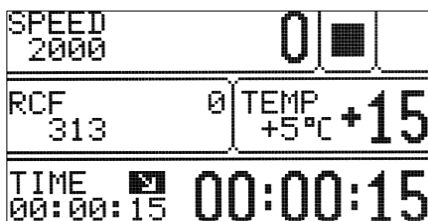

- Then choose **NORMAL DISPLAY** via ▲▼ keys.
- Press SET.

Method II

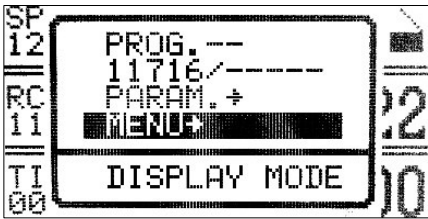

- Press the **BACK** button for **1 sec.**

	<ul style="list-style-type: none"> Via ▲▼ keys select MENU (highlighted). Press SET.
	<ul style="list-style-type: none"> Via ▲▼ keys select CONFIGURATION tab. Press SET. Via ◀▶ keys select SCREEN tab. Via ▲▼ keys select NORMAL DISPLAY. Press SET. Leave menu via BACK key.

10.4 Rotating runtime

Way of time counting	MENU/CONFIGURATION/ ROTATING RUNTIME
	<ul style="list-style-type: none"> Via ▲▼ choose demanded option. Mark it by pressing SET.
Counting from: From pressing start → From reaching speed →	COUNTING SINCE ROTOR IS IDENTIFIED COUNTING FROM ASSIGNED SPEED
Presenting mode: Descending → Ascending →	COUNTING DOWN COUNTING UP

10.5 Buzzer

Switching ON/OFF short audible signals accompanying every pressing of any key. Switching ON/OFF signals after centrifuging.	MENU/ CONFIGURATION / BUZZER
	<ul style="list-style-type: none"> With ▲▼ keys select demanded option. Mark selection by pressing SET. <p>A continuous alarm means the emission of short beeps after the end of the spin, until the message about the end of the work cycle is deleted.</p>
<ul style="list-style-type: none"> Warning signals are always switched on. 	

10.6 Date/time

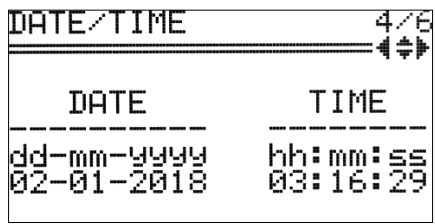
Setting up time and date	MENU/ CONFIGURATION / DATE/TIME
	<ul style="list-style-type: none"> Press SET. Via ◀▶ keys choose demanded value. Via ▲▼ keys change chosen value. Confirm by pressing SET. Repeat above steps for other values. Press BACK.
<ul style="list-style-type: none"> Set date and time are still active even after restart of centrifuge. 	

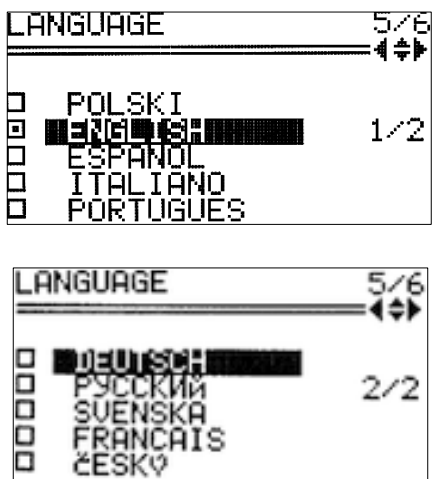

10.7 Language

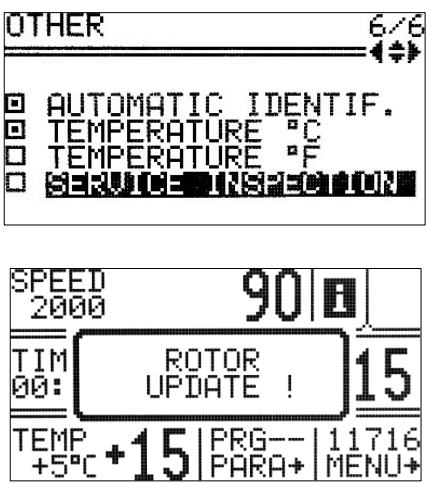

Changing menu language	MENU / CONFIGURATION / LANGUAGE
	<ul style="list-style-type: none"> Via ▲▼ keys choose demanded menu language Mark it by pressing SET.

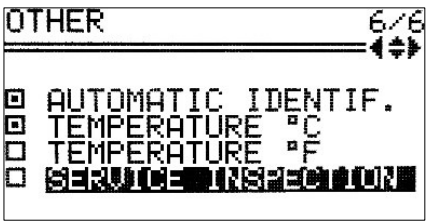
10.8 Other

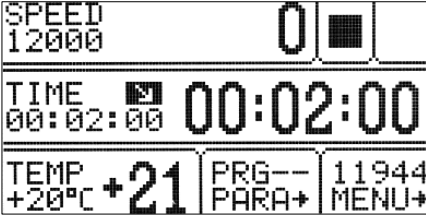
Rotor automatic identification	MENU / CONFIGURATION / OTHER
	<p>Thanks to the automatic rotor identification, the centrifuge automatically identifies the rotor in the chamber. Rotor identification is indicated by the message.</p> <p>When the function is deactivated, it is necessary to manually select the desired rotor as described in "Rotor and bucket choosing".</p> <p>The AUTOMATIC IDENTIF. is turned on by default.</p> <p>To enable/unable the function:</p> <ul style="list-style-type: none"> Via ▲▼ keys choose <ul style="list-style-type: none"> <input type="checkbox"/> AUTOMATIC IDENTIF. Press SET (<input type="checkbox"/> change to <input checked="" type="checkbox"/> or conversely). <p>Autoidentification is not active for work in the loaded program mode.</p>



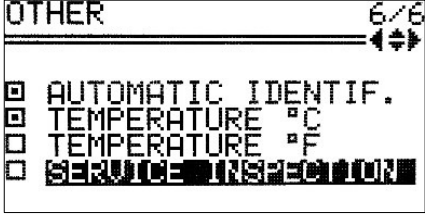
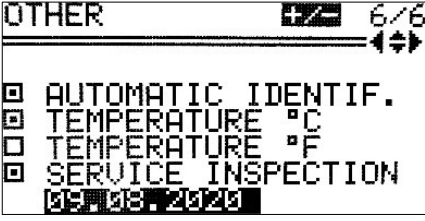



Choice of temperature unit (only MPW-260R)	MENU / CONFIGURATION / OTHER
	<p>The TEMPERATURE in °C is turned on by default.</p> <p>To change the temperature unit:</p> <ul style="list-style-type: none"> Via ▲▼ keys select unit Confirm by pressing SET.

TEMPERATURE IN °C	TEMPERATURE IN °F
	

Service inspection	MENU / CONFIGURATION / OTHER
  	<p>There is a possibility to turn on a message reminding user to perform the inspection, with the option to define the date of the inspection when the message will be displayed.</p> <p>To enable/disable the function:</p> <ul style="list-style-type: none"> Via ▲▼ keys choose <input type="checkbox"/> SERVICE INSPECTION. Press SET (<input type="checkbox"/> change to <input checked="" type="checkbox"/> or conversely). <p>A new field will appear with the date of the inspection (on that day message will be displayed).</p> <p>To edit the date:</p> <ul style="list-style-type: none"> Via ▲▼ keys select date field. Press SET. Via ▲▼◀▶ keys choose value. Confirm by pressing SET.

10.9 Password

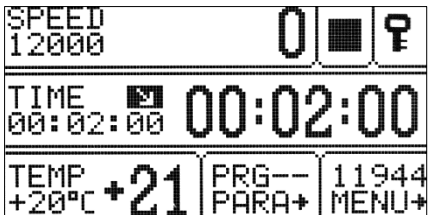
Setting up password	MENU / PASSWORD
<p>To prevent from an unauthorized use, a PASSWORD can be set.</p> <p>Note: No PASSWORD is set by default.</p> <p>The PASSWORD can be set as follows when the rotor is at a standstill.</p>	

	<ul style="list-style-type: none"> ▪ Press SET. Icon  starts blinking. ▪ With ◀▶ keys set the valid place of the PASSWORD. With ▲▼ keys set correct value. ▪ Repeat above steps for all places. ▪ Press SET.
	<ul style="list-style-type: none"> ▪ As a confirmation repeat instructions described above.
<p>When the PASSWORD is set, the Key sign is displayed in the CODE zone. It is also displayed in the main menu (lower right corner of the screen).</p>	
	
<ul style="list-style-type: none"> ▪ From then on, access to the MENU is possible after entering the password. ▪ In case of incorrect password, it will show message: ACCESS DENIED! ▪ To delete the PASSWORD, "0000" must be set (after previously entering current password). If the PASSWORD is forgotten, the emergency code "7654" should be used to clear password and remove all locks. 	
<p>Setting up locks</p>	
	<ul style="list-style-type: none"> ▪ With ▲▼ keys choose a lock. ▪ Mark a lock by pressing SET. ▪ Repeat above steps for desired locks. ▪ Leave menu with BACK key.
	<ul style="list-style-type: none"> ▪ In the LOCK menu, press ◀ and then SET.

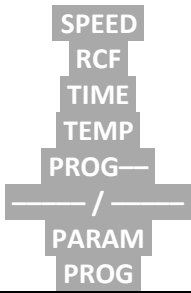
	disabled*	description
SAVE PROGRAM	SAVE button	no programs can be saved
DELETE PROGRAM	DELETE button	no programs can be deleted saving programs on position where one was already stored is disabled
CHANGE PARAMETERS	fields: 	parameters cannot be modified
LOAD PROGRAM	LOAD button	no programs can be called up
START KEY	START key	centrifugation cannot be started

* Executing disabled procedures is only possible after entering the correct password.

10.10 Last 10 cycles

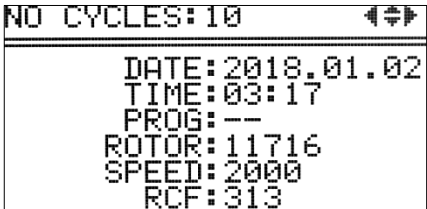
Information concerning parameters of last 10 centrifuging cycles.	MENU / LAST 10 CYCLES
	<ul style="list-style-type: none"> Number of cycles can be changed by ◀▶ keys. The list can be scrolled using ▲▼ keys. To exit press SET/BACK key

10.11 Work time

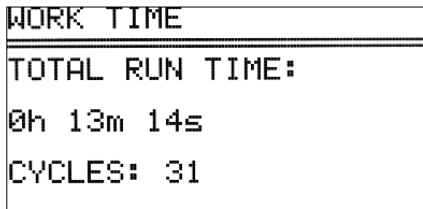
Total working time of centrifuge, and quantity of working cycles.	MENU / WORK TIME
	<p>In the WORK TIME menu, the following statistics are displayed:</p> <ul style="list-style-type: none"> total working (centrifugation) time working cycles counter

10.12 Rotor runtime

Information about the time of centrifuging and of the quantity of the working cycles of each rotor. The table also contains icons warning of the duty of execution of validation.	MENU / ROTOR RUNTIME
-----------------------------------------------------------------------------------------------------------------------------------------------------------------------------------	-----------------------------

11 Maintenance

11.1 Cleaning of the centrifuge

	<ul style="list-style-type: none">▪ Pull the mains plug before cleaning.▪ Before any cleaning or decontamination process other than that is recommended by the manufacturer, the user has to ask the manufacturer if the planned process does not damage the device▪ For cleaning, water with soap or other water-soluble mild detergent shall be used.▪ One should avoid corrosive and aggressive substances. It is prohibited to use alkaline solutions, inflammable solvents or agents containing abrasive particles.▪ Do not lubricate the centrifuge motor shaft.▪ The unused centrifuge should have cover opened. <p>Once a week</p> <ul style="list-style-type: none">▪ Using wiping cloth, remove condensate or residues of the products from the rotor chamber. <p>Once a month</p> <ul style="list-style-type: none">▪ Check the rotor clamping thread. In case of damage, replaced it.▪ Check the centrifuging chamber whether it is damaged. In case of damage, it cannot be longer put into operation. Notify authorized service workshop.
-----------------------------------------------------------------------------------	--------------------------------------------------------------------------------------------------------------------------------------------------------------------------------------------------------------------------------------------------------------------------------------------------------------------------------------------------------------------------------------------------------------------------------------------------------------------------------------------------------------------------------------------------------------------------------------------------------------------------------------------------------------------------------------------------------------------------------------------------------------------------------------------------------------------------------------------------------------------------------------------------------------------------------------------------------------------------------------------------------------------------------------------------------------------------------------------------------------------------------------------------------------------------------------------

11.2 Maintenance of centrifuge elements

	<p>The rotor pins shall be always lubricated with petroleum jelly.</p> <p>In this way, the uniform deflection of the buckets and quiet centrifuge operation is ensured.</p>
-------------------------------------------------------------------------------------	-----------------------------------------------------------------------------------------------------------------------------------------------------------------------------

Cleaning of the accessories

	<ul style="list-style-type: none">▪ In order to ensure safe operation, one shall carry out in regular way periodical maintenance of the accessories.▪ Rotors, buckets and round carriers have to withstand high stresses originating from the centrifugal force. Chemical reactions as well as corrosion (combination of variable pressure and chemical reactions) can cause destruction of metals. Hard to observe surface cracks increase gradually and weaken material without visible symptoms.▪ In case of observation of surface damage, crevice or other change, as well as the corrosion, the given part (rotor, bucket, etc.) shall be immediately replaced.▪ Clamping rotor, containers and reducer inserts must be cleaned regularly to prevent corrosion.▪ Cleaning of the accessories shall be carried out outside of the centrifuge once every week or still better after each use. For cleaning them one should use neutral agent of pH value 6÷8. It is forbidden to use alkaline agent of pH > 8. Then, those parts shall be dried using soft fabric or in the chamber drier at ca. 50°C.▪ Angle rotor should be placed on a fabric with holes facing down, for effective drying.▪ Do not use bleach on plastic parts of the rotor.▪ In this way, the useful service life of the device is substantially increased and susceptibility to corrosion is diminished. Accurate maintenance increases the service life as well and protects against premature rotor failures.
-------------------------------------------------------------------------------------	------------------------------------------------------------------------------------------------------------------------------------------------------------------------------------------------------------------------------------------------------------------------------------------------------------------------------------------------------------------------------------------------------------------------------------------------------------------------------------------------------------------------------------------------------------------------------------------------------------------------------------------------------------------------------------------------------------------------------------------------------------------------------------------------------------------------------------------------------------------------------------------------------------------------------------------------------------------------------------------------------------------------------------------------------------------------------------------------------------------------------------------------------------------------------------------------------------------------------------------------------------------------------------------------------------------------------------------------------------------------------------------------------------------------------------------------------------------------------------------------------------------------------------------------------------------------------------------------

	<ul style="list-style-type: none"> ▪ Do not use bleach on plastic parts of the rotor. ▪ According to laboratory standards, minimize the immersion time in each solution. ▪ Especially prone to the corrosion are parts made of aluminum. ▪ Corrosion and damages resulting from insufficient maintenance could not be subject of claims lodged against the manufacturer. ▪ The unused rotor should have the lid removed.
--	-----------------------------------------------------------------------------------------------------------------------------------------------------------------------------------------------------------------------------------------------------------------------------------------------------------------------------------------------------------------------------------------------------------------------------------------------------------------------------

HS accessories maintenance.

	<ul style="list-style-type: none"> ▪ Check the general condition of seals. ▪ Make sure that rubber O-rings are lightly coated with silicone grease. Use high vacuum grease, e.g., type „C” by LUBRINA. ▪ In order to maintain hermetic sealing, it is recommended to replace the sealing rings after each autoclaving. ▪ Store hermetically sealed rotors and buckets with the lids removed.
-----------------------------------------------------------------------------------	----------------------------------------------------------------------------------------------------------------------------------------------------------------------------------------------------------------------------------------------------------------------------------------------------------------------------------------------------------------------------------------------------------------------------------------

11.3 Sterilization

Plastics - legend to abbreviations

PS	polystyrene	ECTFE	ethylene/chlorotrifluoroethylene
SAN	styrene-acrylonitrile	ETFE	ethylene/tetrafluoroethylene
PMMA	polymethyl methacrylate	PTFE	polytetrafluoroethylene
PC	polycarbonate	FEP	tetrafluoroethylene/perfluoro propylene
PVC	polyvinyl chloride	PFA	tetrafluoroethylene/perfluoroalkylvinylether
POM	acetal polyoxymethylene	FKM	fluorocarbon rubber
PE-LD	low density polyethylene	EPDM	ethylene propylene diene
PE-HD	high density polyethylene	NR	natural rubber
PP	polypropylene	SI	silicon rubber
PMP	polymethyl pentene		

One can use all standard disinfectants. Centrifuges and devices are made of different materials, one should consider their variety.

	radiation β radiation γ 25 kGy	C ₂ H ₄ O (ethylene oxide)	formalin, ethanol
PS	●	○	●
SAN	○	●	●
PMMA	●	○	●
PC	●	●	●
PVC	○	●	●
POM	●	●	●
PE-LD	●	●	●
PE-HD	●	●	●
PP	●	●	●
PMP	●	●	●
ECTFE, ETFE	○	●	●
PTFE	○	●	●
FEP, PFA	○	●	●
FKM	○	●	●
EPDM	○	●	●

NR	○	●	●
SI	○	●	●

- may be used
- cannot be used

In the centrifuge, disinfectants and cleaning agents generally used in medical care should be used (e.g., *Aerodesina-2000*, *Lysoformin 3000*, *Melseptol*, *Melsept SF*, *Sanepidex*, *Cutasept F*).

11.3.1 Autoclaving

- Rotors, buckets and round carriers can be sterilized in autoclave with temperature 121°C during 20 min (215 kPa), unless otherwise specified in the OPTIONAL ACCESSORY.
- During sterilization (autoclaved) by means of steam one should consider temperature resistance of individual materials.
- Deformation of the accessories (carriers or lids made of plastic) may occur during autoclaving.
- Do not autoclave disposable materials (e.g., tubes, cyto-container).
- The life of the accessory depends on the frequency of autoclaving and use.
- Autoclaving reduces lifespan of plastic components. They should be replaced if any signs of damage are visible, including a change in color or shape or when leakage etc.
- Pressure in closed containers can cause plastic deformation or explosion.
- Prior to autoclaving the rotors and accessories, thoroughly wash and rinse with distilled water.
- Never exceed the permissible autoclaving temperature and time.
- If you want to keep the hermetic seals, replace the sealing rings after each autoclave.

Chemical resistance of plastics

	autoclaving 121 °C, 20 min		autoclaving 121 °C, 20 min
PS	○	PMP	●
SAN	○	ECTFE, ETFE	●
PMMA	○	PTFE	●
PC	●	FEP, PFA	●
PVC	○ ¹⁾	FKM	●
POM	●	EPDM	●
PE-LD	○	NR	○
PE-HD	○	SI	●
PP	●		

- may be used
- cannot be used

1) Except PVC hoses which are resistant to the steam sterilization in the temperature 121°C.

11.4 Chemical resistance



Chemical resistance of plastics

	aldehydes	cyclic alcohols	esters	ether	ketones	strong or concentrated acids	weak or diluted acids	oxidizing substances	cyclic hydrocarbons	acids	haloid hydrocarbons	alkalis
PS	○	●	○	○	○	○/●	○/●	○	○	○	○	●
SAN	○	●	○	○	○	○	○/●	○	○	○	○	●
PMMA	○/●	●	○	○	○	○	○/●	○	○/●	○	○	○
PC	○/●	●	○	○	○	○	○/●	○	○/●	○	○	○
PVC	○	●	○	○	○	●	●	○	●	○	○	●
POM	○/●	●	○	●	●	○	○	○	●	●	●	●
PE-LD		●	●	●	○/●	●	●	○	●	●	●	●
PE-HD	●	●	○/●	○/●	○/●	●	●	○	●	○/●	○/●	●
PP	●	●	○/●	○/●	○/●	●	●	○	●	○/●	○/●	●
PMP	○/●	●	○/●		○/●	●	●	○	○/●	○	○	●
ECTFE ETFE	●	●	●	●	○	●	●	●	●	●	●	●
PTFE FEP PFA	●	●	●	●	●	●	●	●	●	●	●	●
FKM	●	○	○	○	○	○	●	○/●	○/●	○/●	○/●	○/●
EPDM	●	●	○/●	○	○/●	●	●	○/●	○	○	○	●
NR	○/●	●	○/●	○	○	○	○/●	○	○	○	○	●
SI	○/●	●	○/●	○	○	○	○/●	○	○	○	○	○/●

●	very good	Permanent action of the substance does not cause damage through 30 days. The material is able to be resistant through years
○/●	good to limited	Continuous action of the substance causes insignificant and partly reversible damage through the period of 7-30 days (e.g., puffing up, softening, reduced mechanical durability, discoloring).
○	limited	The material should not have the continuous contact with the substance. The immediate occurrence of damage is possible (e.g., the loss of mechanical durability, deformation, discoloring, bursting, dissolving).







Rubber inserts shall be exactly cleaned or possibly replaced. Centrifuges and accessories are made of different materials.

Do not use bleach on plastic parts of the rotor.

	DANGER! MPW accessories are not biotight. For centrifuging infectious materials, it is necessary to use hermetically closed tubes meeting demands of biotightness, in order to prevent germs migration into the centrifuge and beyond it.
	User is responsible for proper disinfections of the centrifuge if some dangerous material was spilled inside or outside of the centrifuge. During the above mentioned works one must wear safety gloves.

12 Troubleshooting

Majority of faults could be removed by switching the centrifuge OFF and then ON. After switching the centrifuge ON, there shall be displayed parameters of the recently implemented program and sound signals comprising four successive tones shall be generated. In case of short-duration power failure the centrifuge terminates the cycle and displays PROGRAM ERROR code.

problem	question	remedy
Centrifuge does not start	Is supply cable plugged into mains?	Plugs supply cable correctly.
	Is master switch ON?	Switch ON power supply.
Motor error is displayed		Call service.
Centrifuge does not start (indications are proof for cycle in progress and motor does not start)	Is  symbol displayed?	Wait till rotor stops and the  symbol goes off.
	Is  symbol displayed?	Close cover.  symbol must switch off.
	Is  symbol blinking?	Centrifugation cycle in progress, press STOP key or wait till cycle ends.
Centrifuge does not accelerate (unbalance error)	Unequal rotor load.	Centrifuge load shall be balanced.
	Inclined centrifuge.	Centrifuge shall be levelled.
	Faulty drive (mechanical damage).	Call service.
	Was centrifuge displaced during operation?	Switch ON the centrifuge again after opening and closing the cover.
(motor error)	After stopping error rotor message is displayed	Check if rotor number in started program is consistent with the number of the rotor installed in the centrifuge. Check rotor status (if there are coding magnets inserted)
	Centrifuge does not recognize the rotor and does not stop.	Switch the centrifuge OFF, then ON and check correctness of loaded program
It is not possible to open the cover	 symbol on the display is blinking, after pressing COVER key single tone is audible	Rotor is still rotating. Wait for stopping of the rotor and displaying of the  symbol.
	The sensor is connected correctly, and the error is still applying.	Call service.
Mains failure during run	The message will be displayed on the display about the decay of tension.	Wait for stopping of the rotor, clear the error by pressing the SET key.
Temperature sensor error	The overheating message will be displayed.	Switch the centrifuge OFF, then ON.
		Call service.
Error of the exceeding the temperature (50°C) in the chamber	The overheating message will be displayed.	Open the cover. Wait for the centrifuge to cool down.

12.1 Messages

Screen messages that may occur during operation.	
MESSAGE	EXPLANATION
"SPEED OF ROTOR" "IDENTIFICATION <> 90 RPM"	Please try start centrifuging again, if error still occur, contact manufacturer's authorized service.
"IMBALANCE FAST STOP !" "PLEASE REMOVE CAUSE" "THEN RESTART"	Rotor is not balanced correctly, please balance rotor.
"NO ROTOR OR IDENTIFICATION" "SENSOR DAMAGED !"	Make sure, is rotor mounted in the centrifuge chamber. If it is right contact manufacturer's authorized service.
"INCORRECT ROTOR NUMBER !"	Change rotor number in centrifuge settings or use autoidentification.
"WRONG DIRECTION OF ROTATION" "OR UNKNOWN ROTOR !"	Make sure if correct rotor for centrifuge is mounted. List of accessories is described in chapter 15.
"PLEASE CLOSE THE LID" "HAND !"	Necessity of manually closing the lid.

"ROTOR STOPPING !" "Please wait..."	Initializing after mains failure with rotating rotor, wait until rotor stop.
----------------------------------------	------------------------------------------------------------------------------

Emergency messages	
In case of emergency messages (centrifuge is not working properly) contact the manufacturer's authorized service center.	
MESSAGE	
"OVERHEATING MOTOR !" "INVERTER ERROR !"	
"INVERTER SERIAL BUS ERROR !"	
"TEMPERATURE SENSOR ERROR"	
"PRESSURE CONTROL FAILURE!"	
"OPENING COVER in RUN!"	
"SPEED METER ERROR"	
"I2C BUS ERROR"	
"OVERHEATING CENTRIFUGE !"	
"ROTOR OVERSPEED !"	
"COVER LOCK MALFUNCTION !"	

12.2 Emergency cover release

	<p>EMERGENCY COVER RELEASE</p> <p>Attention! <i>The cover may be opened in emergency only when the rotor is at rest. Before emergency opening the cover, switch off the mains power switch and disconnect the power cord. Wait 10 min and/or looking through the sight glass, make sure that the rotor is not rotating.</i></p> <p>There is a plug on the right-hand side, which must be unscrewed counterclockwise using the emergency lid release key (catalog no. 18640). Then pull on the cap until the cover is open.</p> <p>The emergency opening of the cover can be used, for example, in the event of a power failure, failure of the control panel, etc.</p>
-------------------------------------------------------------------------------------	--------------------------------------------------------------------------------------------------------------------------------------------------------------------------------------------------------------------------------------------------------------------------------------------------------------------------------------------------------------------------------------------------------------------------------------------------------------------------------------------------------------------------------------------------------------------------------------------------------------------------------------------------------------------------------------

13 Guarantee

Manufacturer grants to the Buyer the guarantee on conditions specified in the Guarantee Certificate. Buyer forfeits the right to guarantee repair when using the device inconsistently with the User manual provisions, when damage results from the User's fault.

Repairs should be carried out in authorized service workshops, granted with the MPW Certificate.

The centrifuge shall be sent to repair after decontaminating disinfections. Information about authorized service workshops could be obtained from the Manufacturer.

	<ul style="list-style-type: none"> ▪ Guarantee period amounts to 24 months (unless otherwise specified in the purchase documents). ▪ Guarantee conditions are described in guaranteed card. ▪ The service life of the centrifuge specified by the manufacturer amounts to 10 years. ▪ After 24 months from the start of the warranty period (date of purchase), a technical inspection of the centrifuge should be carried out (validation) by an authorized service of the manufacturer. Subsequent inspections should be carried out at annual intervals. ▪ Maximum period of storage of not used centrifuge amounts to 1 year. After this period, a service authorized by manufacturer should carry out technical inspection of the centrifuge. ▪ Manufacturer reserves the right to make technical changes in manufactured products.
-----------------------------------------------------------------------------------	------------------------------------------------------------------------------------------------------------------------------------------------------------------------------------------------------------------------------------------------------------------------------------------------------------------------------------------------------------------------------------------------------------------------------------------------------------------------------------------------------------------------------------------------------------------------------------------------------------------------------------------------------------------------------------------------------------------------------------------------------------------------------------------------------------------------------------------------------------------------------------------------------

14 Transport and storage

	<p>CAUTION! Due to the heavy weight of the device, lifting and carrying it may cause injury to the spine.</p>
<p>Store the device only in a closed and dry room. Remove rotor from centrifuge before transport. Lift and carry with the adequate number of people. Use transport equipment. Use the original packaging and transport protection for transport.</p>	

14.1 Transport and storage conditions

	Storage (in the package)	Storage (without the package)	Transport
Temperature	-25 ÷ +55 °C	-5 ÷ +45 °C	-25 ÷ +60 °C (general) -20 ÷ +55 °C (air)
Relative humidity	10 ÷ 75 %	10 ÷ 75 %	10 ÷ 75 %
Pressure	70 ÷ 106 kPa	70 ÷ 106 kPa	30 ÷ 106 kPa

15 Disposal

	<ul style="list-style-type: none"> ▪ Dispose of the device in accordance with the applicable legal regulations in the country of use. ▪ In the countries of the European Community, the disposal of electrical equipment is regulated under the EU Directive 2012/19/EU on waste electrical and electronic equipment (WEEE). According to these regulations, centrifuges may not be collected together with municipal or household waste. ▪ Disposal regulations in individual EU countries may differ. In case of doubt, please contact the supplier of the device.
-------------------------------------------------------------------------------------	-------------------------------------------------------------------------------------------------------------------------------------------------------------------------------------------------------------------------------------------------------------------------------------------------------------------------------------------------------------------------------------------------------------------------------------------------------------------------------------------------------------------------------------------------------------------------------------------------------

16 Manufacturer's info

"MPW MED. INSTRUMENTS" SPÓŁDZIELNIA PRACY

Boremlowska 46 Street

04-347 Warsaw

tel. (+48) 22 610 56 67 (sales department - POLAND)
(+48) 22 879 70 46 (sales department - outside POLAND)
(+48) 22 610 81 07 (service)
fax: (+48) 22 610 55 36
e-mail: mpw@mpw.pl
website: www.mpw.pl

000042924 - number of entry in the Waste Database

PL/CA01-01782 - identification number given by Office for Registration of Medicinal Products,
Medical Devices and Biocidal Products.

Distributor's info

DISTRIBUTOR:

17 Annexes

A. Wyposażenie dodatkowe/Optional accessories
MPW-150R
WIRNIK / ROTOR

 PARAMETRY/PARAMETERS (RCF [\times g], Rmax [mm], α [°])

POJEMNIK/BUCKET

WKŁADKA / ADAPTER

[liczba próbek na wirnik/tubes per rotor] PROBÓWKA / TUBE

11199
RPM 15000 RCF 16854 Rmax 67 α 45
bez pojemnika/without bucket
bez wkładki/without adapter

[12] * 2-1,5 ml probówka (10,8x41,8 mm), Eppendorf®; [15011], 2 ml (10,8x41,8 mm); [15128], 1,5ml (10,8x40,5 mm)

14084

 [12] 15127 0,5 ml probówka PCR (7,8 x 31 mm)
0,5 ml PCR tube (7,8 x 31 mm)

14126

 [12] 15124 0,4 ml probówka PCR (5,7 x 48,6 mm)
0,4 ml PCR tube (5,7 x 48,6 mm)

14133

 [12] 15125 0,2 ml probówka PCR (6 x 21,6 mm)
0,2 ml PCR tube (6 x 21,6 mm)

11461
RPM 15000 RCF 20879 Rmax 83 α 45
bez pojemnika/without bucket
bez wkładki/without adapter

[24] * 2-1,5 ml probówka (10,8x41,8 mm), Eppendorf®; [15011], 2 ml (10,8x41,8 mm); [15128], 1,5ml (10,8x40,5 mm)

14084

 [24] 15127 0,5 ml probówka PCR (7,8 x 31 mm)
0,5 ml PCR tube (7,8 x 31 mm)

14126

 [24] 15124 0,4 ml probówka PCR (5,7 x 48,6 mm)
0,4 ml PCR tube (5,7 x 48,6 mm)

14133

 [24] 15125 0,2 ml probówka PCR (6 x 21,6 mm)
0,2 ml PCR tube (6 x 21,6 mm)

11716
RPM 15000 RCF 17609 Rmax 70 α 45
bez pojemnika/without bucket
bez wkładki/without adapter

 [4] 15122 8 x 0,2 ml probówki szeregowo PCR-strip (10,2 x 72,4 mm)
8 x 0,2 ml PCR strip (10,2 x 72,4 mm)

 [32] 15125 0,2 ml probówka PCR (6 x 21,6 mm)
0,2 ml PCR tube (6 x 21,6 mm)

 [4] 15130 8 x 0,2 ml probówki szeregowo PCR strip (7,3 x 77,2 mm)
8 x 0,2 ml PCR strip (7,3 x 77,2 mm)

 [4] 15131 4 x 0,2 ml probówki szeregowo PCR-strip (10,2 x 37,2 mm)
4 x 0,2 ml PCR strip (10,2 x 37,2 mm)

11760
RPM 15000 RCF 21382 Rmax 85 α 45
bez pojemnika/without bucket
bez wkładki/without adapter

[24] * 2-1,5 ml probówka (10,8x41,8 mm), Eppendorf®; [15011], 2 ml (10,8x41,8 mm); [15128], 1,5ml (10,8x40,5 mm)

 [24] * 2 ml probówki z filtrem - spin columns (10,8 x 46 mm)
2 ml spin columns (with filter) (10,8 x 46 mm); [15011], 2 ml (10,8x41,8 mm); [15128], 1,5ml

14084

 [24] 15127 0,5 ml probówka PCR (7,8 x 31 mm)
0,5 ml PCR tube (7,8 x 31 mm)

14126

 * probówka niedostępna w ofercie MPW lub dostępny odpowiednik (np.[15050]), patrz kolumna z prawej
tube is not offered by MPW or equivalent is available (e.g. [15050]), see column on the right

A. Wyposażenie dodatkowe/Optional accessories**MPW-150R**

[24] 15124 0,4 ml probówka PCR (5,7 x 48,6 mm)
0,4 ml PCR tube (5,7 x 48,6 mm)

14133

[24] 15125 0,2 ml probówka PCR (6 x 21,6 mm)
0,2 ml PCR tube (6 x 21,6 mm)

11942**RPM 6000 RCF 3542 Rmax 88 \pm 30****13080****14082**

[6] 15054 6 ml probówka z pokrywką (11,5 x 92 mm), Sarstedt®
6 ml tube with cap (11,5 x 92 mm), Sarstedt®

[6] * BD Vacutainer® (13 x 100 mm), (4-7 ml)

[6] * Greiner Vacuette® (13 x 100 mm), (3,5-6 ml)

[6] * Sarstedt S-Monovette® (11 x 92 mm), (4,5; 5 ml)

[6] 15119 7 ml probówka szklana (12 x 100 mm)

7 ml glass tube (12 x 100 mm)

RCF max.=3000 RPM max.=5522

bez wkładki/without adapter

[6] 15046 14 ml probówka z pokrywką (16,8 x 113,7 mm), Sarstedt®

14 ml tube with cap (16,8 x 113,7 mm), Sarstedt®

[6] 15048 15 ml Thermo Nalgene® (16 x 113 mm)

15 ml Thermo Nalgene® (16 x 113 mm)

[6] 15053 10 ml probówka z pokrywką (16 x 106 mm)

10 ml tube with cap (16 x 106 mm)

[6] * 15 ml probówka z dnem stożkowym z zakrętką (17 x 120 mm), Falcon®; [15050], 15ml (17 x 120 mm)

15 ml tube, conical bottom, with cap (17 x 120 mm), Falcon®; [15050] 15ml Sarstedt®(17 x 120 mm)

[6] * BD Vacutainer® (16 x 100 mm), (2,5-11 ml)

[6] * Greiner Vacuette® (16 x 100 mm), (7-9 ml)

[6] * Sarstedt S-Monovette® (15 x 92 mm), (7,5; 8,2; 8,5 ml)

[6] * Sarstedt S-Monovette® (16 x 92 mm), (9; 10 ml)

[6] 15118 10 ml probówka szklana (16 x 100 mm)

10 ml glass tube (16 x 100 mm)

RCF max.=3000 RPM max.=5522

14082+14815

[6] 15120 5 ml probówka szklana (12 x 75 mm)

5 ml glass tube (12 x 75 mm)

RCF max.=3000 RPM max.=5981

14082+14815 Rmax 75 RCF 3019

[6] * BD Vacutainer® (13 x 75 mm), (1,6-5,3 ml)

[6] * Greiner Vacuette® (13 x 75 mm), (1-4,5 ml)

[6] * Sarstedt S-Monovette® (11 x 66 mm), (1,6; 2; 2,7; 3; 3,1 ml)

[6] * Sarstedt S-Monovette® (13 x 65 mm), (2,6; 2,9; 3,4; 3,8 ml)

[6] * Sarstedt S-Monovette® (13 x 75 mm), (2,7; 3; 4,3 ml)

14815 Rmax 75 RCF 3019

[6] 15121 10 ml probówka z dnem okrągłym i pokrywką (17 x 70 mm)

10 ml tube, round bottom, with cap (17 x 70 mm)

[6] * Sarstedt S-Monovette® (15 x 75 mm), (4; 4,3; 5,5 ml)

[6] * 10 ml Thermo Nalgene® Oak Ridge (16 x 81,5 mm)

11943**RPM 15000 RCF 21382 Rmax 85 \pm 45****bez pojemnika/without bucket****bez wkładki/without adapter**

[20] * 1,6 ml probówka Cryo (12,3 x 46,5 mm)

1,6 ml Cryo tube (12,3 x 46,5 mm)

[20] * 1,8 ml probówka Cryo (12,3 x 46,5 mm)

1,8 ml Cryo tube (12,3 x 46,5 mm)

11944**RPM 15000 RCF 21382 Rmax 85 \pm 45****bez pojemnika/without bucket****bez wkładki/without adapter**

[6] * 5 ml probówka z korkiem zakręcany (17 x 66 mm), Eppendorf®

5 ml tube with screw cap (17 x 66 mm), Eppendorf®

[12] * 5 ml probówka z korkiem wciskany (17 x 54,2 mm), Eppendorf®

5 ml tube with snap cap (17 x 54,2 mm), Eppendorf®

12300**RPM 13000 RCF 16816 Rmax 89 \pm 90**

A. Wyposażenie dodatkowe/Optional accessories**MPW-150R**

bez pojemnika/without bucket

bez wkładki/without adapter

[24]	15100	37 µl kapilara hematokrytowa (1,4 x 75 mm)
		37 µl micro-hematocrit capillary tube (1,4 x 75 mm)

Suma końcowa

EU DECLARATION OF CONFORMITY

This EU declaration of conformity is issued under the sole responsibility of the manufacturer.

Manufacturer: **"MPW MED. INSTRUMENTS" SPÓŁDZIELNIA PRACY**
46 Boremłowska Street, 04-347 Warsaw, Poland

We apply the certified
Quality Management System
in accordance
with the standards: PN-EN ISO 9001:2015, PN-EN ISO 13485:2016

Product name: **Refrigerated laboratory centrifuge MPW-150R**

The aforementioned product is in conformity with the following EU regulations and directives:

- **2017/746 (IVDR)** REGULATION (EU) 2017/746 OF THE EUROPEAN PARLIAMENT AND OF THE COUNCIL of 5 April 2017 on in vitro diagnostic medical devices and repealing Directive 98/79/EC and Commission Decision 2010/227/EU
- **2011/65/UE (RoHS 2)** DIRECTIVE 2011/65/EU OF THE EUROPEAN PARLIAMENT AND OF THE COUNCIL of 8 June 2011 on the restriction of the use of certain hazardous substances in electrical and electronic equipment

Intended purpose: The product is a benchtop laboratory centrifuge specifically intended by the manufacturer for in vitro diagnostic (IVD) procedures. It is used for the separation of mixtures, suspensions, body fluids into components of different density under the influence of centrifugal force.

Risk class: **Class A (in accordance with Annex VIII, rule 5)**

The assessment of the conformity of the device has been carried out in accordance with Article 48(10) of Regulation (EU) 2017/746.

Wojciech Anisiewicz
Vice-President of the Management Board

Łukasz Sałański
President of the Management Board

DECLARATION OF DECONTAMINATION

(repair)

In order to protect our employees please fill out the declaration of decontamination completely before sending centrifuge to the manufacturer (repair).

1. Device:

– type:

– serial No.:

2. Description of decontamination

(see user manual)

.....

.....

.....

.....

3. Decontamination carried out by:

name:

4. Date and signature:

.....

DECLARATION OF DECONTAMINATION

(return)

In order to protect our employees please fill out the declaration of decontamination completely before sending centrifuge to the manufacturer (return).

1. Device:

– type:

– serial No.:

2. Description of decontamination

(see user manual)

.....

.....

.....

.....

3. Decontamination carried out by:

name:

4. Date and signature:

.....

NOMOGRAM

Centrifuging radius [cm]

R.C.F. (x "g")
multiple of
gravitational
acceleration

[r.p.m.]

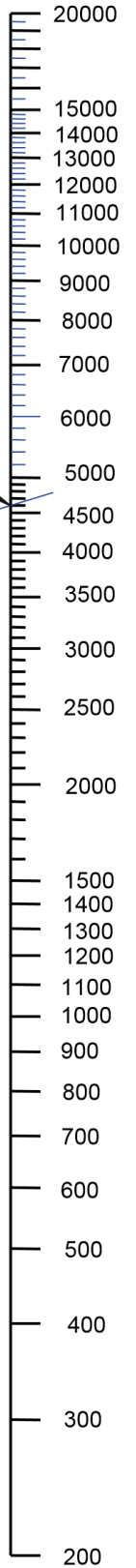
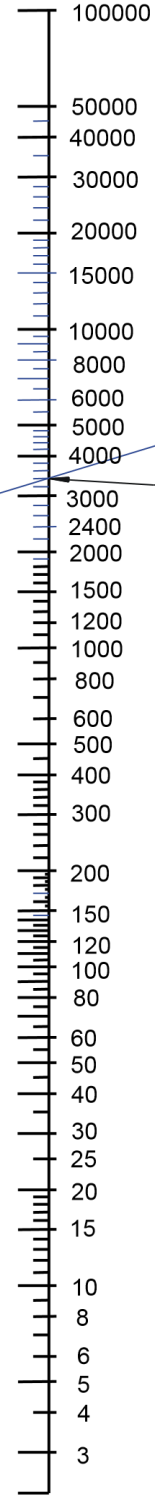
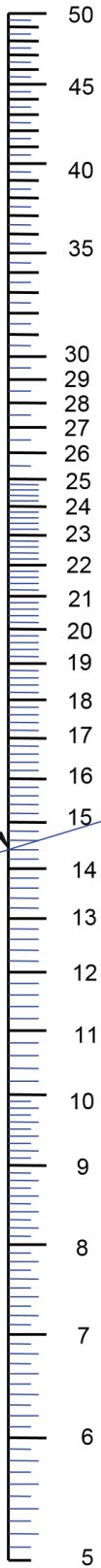

Formula used for calculation of this nomogram :

$$R.C.F. = 11,18 * r * (n/1000)^2$$

where :

- R.C.F. - multiple of gravitational acceleration
- r - centrifuging radius (cm)
- n - rotational speed (r.p.m.)
- g - gravitational acceleration

Example of making use
of the nomogram:

A=14,4 cm
B=4600 r.p.m.
C=3400 x g

$$n = 1000 * \sqrt{\frac{RCF}{(11,18 * r)}}$$

$$r = \frac{RCF}{\left[11,18 * \left(\frac{n}{1000} \right)^2 \right]}$$

A

B

C