

USER MANUAL



Laboratory centrifuge **MPW-260** Refrigerated laboratory centrifuge **MPW-260R**

Read before use!

Serial number of the centrifuge:

For centrifuges with serial no (SN): MPW-260: from 10260041122
 MPW-260R: from 10260R153022



This manual was prepared with special care. MPW MED. INSTRUMENTS may change the manual at any time and without notice because of improvements, typographical errors or improvements to facilities. All rights reserved. No part of this User Manual may be modified, distributed, published or reproduced without the prior permission of MPW MED. INSTRUMENTS.

You can find the current version of the user manual on our website under:









mpw.pl/en – DOWNLOAD section (one can choose demanded language version of website).

Content

1. Symbols used in the manual and on the device	5
2. Application	5
3. Technical specification	6
3.1 Environmental conditions	6
4. Installation	7
4.1 Content of the package	7
4.2 Location	7
4.3 Current protection	8
5. Safety notes	8
5.1 General remarks	8
5.2 Filling the rotor	8
5.2.1 <i>Angular rotors</i>	8
5.2.2 <i>Horizontal rotors</i>	9
5.2.3 <i>Filling tubes</i>	9
5.3 Safety hints	10
5.4 Operating conditions	11
5.5 Equipment life	11
5.6 Work safety	11
5.7 Unbalance	12
5.8 Emergency stops	13
5.9 Residual risk	13
6. Operating	14
6.1 Centrifuge overview	14
6.2 Centrifuge description	14
6.3 Construction	15
6.4 Name plate	15
6.5 Rotor and accessories installation	15
6.6 Control device	16
6.7 Setting parameters	16
6.8 Safety features	16
6.9 Increase in temperature (MPW-260 only)	17
7. Centrifuging	17
7.1 Control panel	17
7.2 Display	18
7.3 Setting up RPM, RCF, time, temperature	19
7.4 User's programs	21
7.5 Creator of acceleration and deceleration curves	23
7.5.1 <i>Acceleration characteristic, creation of episode 1</i>	23
7.5.2 <i>Adding and editing sections - acceleration</i>	24
7.5.3 <i>Acceleration graph</i>	25
7.5.4 <i>Deceleration characteristic, creation of episode 1</i>	25
7.5.5 <i>Adding and editing sections - deceleration</i>	26
7.5.6 <i>Deceleration graph</i>	26
7.5.7 <i>Deleting sections</i>	27
7.6 Programs with user characteristics	27
7.7 Rotor and bucket choosing	27
7.8 SHORT mode	28
7.9 Finishing the centrifuging	28
7.10 Temporarily disabled functions	29
8. Temperature control	29
8.1 Initial cooling during centrifuging –FAST COOL	29

8.2	Initial cooling without centrifuging – THERMAL CHAMBER	30
8.3	Cooling in “START DELAY – OF TEMPERATURE” mode.....	30
8.4	Cooling in „SHORT” mode	30
8.5	Cooling notes.....	30
9.	Parameters of centrifugation	30
9.1	Acceleration/deceleration – changing characteristics	31
9.2	Radius	32
9.3	Sample density	32
9.4	Temperature offset	32
9.5	Thermal chamber	33
9.6	Automatic lid opening	34
9.7	Start delay - of time	34
9.8	Start delay – of temperature	34
9.9	Printing report (USB)	35
10.	Menu	39
10.1	Screen saver	39
10.2	Visual alarm	40
10.3	Types of main screen.....	40
10.3.1	Switching the normal display to simplified display	40
10.3.2	Switching the simplified screen to normal display	41
10.4	Rotating runtime	42
10.5	Buzzer	42
10.6	Date/time	43
10.7	Language	43
10.8	Other	43
10.9	Password	44
10.10	Last 10 cycles	46
10.11	Work time	46
10.12	Rotor runtime	46
10.13	Contact us	47
10.14	Diagnostics.....	47
10.15	Factory settings	47
11.	Maintenance	48
11.1	Cleaning of the centrifuge	48
11.2	Maintenance of centrifuge elements	48
11.3	Sterilization.....	49
11.3.1	Autoclaving	50
11.4	Chemical resistance	51
12.	Troubleshooting.....	51
12.1	Messages	52
12.2	Emergency cover release.....	53
13.	Guarantee	53
14.	Transport and storage.....	54
15.	Disposal	54
16.	Manufacturer’s info	55
	Distributor’s info	55
17.	ANNEXES.....	55
A.	Additional accessories	
B.	Declaration of conformity (CE, ROHS 2)	
C.	Declaration of decontamination (repair / return)	
D.	Nomogram RPM / RCF	

1. Symbols used in the manual and on the device

Symbol	Explanation
	WARNING! Warning of potential injury or health risk
	DANGER! Risk of electric shock with potential for severe injury or death as a consequence
	DANGER! Biohazard with potential for risk to health or death as a consequence
	DANGER! Risk of explosion with potential for severe injury or death as a consequence
	Symbol identifying a medical device for in vitro diagnostic use
	CE mark
	Symbol informing about the method of disposal
	Please read the instruction manual before you start working with the device
	Manufacturer's data

The terms "**accessories**", "**optional accessories**" and "**equipment**" used in this manual mean the components of the centrifuge, such as: rotors, containers and reducing inserts

2. Application

- The **MPW-260/R** centrifuges (MPW-260 – ventilated, MPW-260R – with cooling) belong to the family MPW-260/R of the tabletop non-automatic laboratory centrifuges.
- The devices are intended for In Vitro Diagnostics (IVD). This means that it is an in vitro diagnostic medical device - in accordance with the Regulation of the European Parliament and of the Council (EU) of 5 April 2017 on in vitro diagnostic medical devices and repealing Directive 98/79/EC and Commission Decision 2010 /227/EU.
- The centrifuge is used to separate aqueous solutions and suspensions of samples with a density not higher than **1.2g/cm³** taken from human, animal and plant organisms into

components of different densities under the influence of centrifugal force, in order to provide information about their biological state and to other analytical work.

- The design of the centrifuge ensures ease of use, safe operation and a wide range of applications in medical, biochemical and other analysis laboratories.
- The centrifuge is not biotight, therefore, when centrifuging preparations that require biotightness, containers and rotors with a biotightness certificate should be used.

3. Technical specification

manufacturer	"MPW MED. INSTRUMENTS" SPÓŁDZIELNIA PRACY, Boremłowska 46 Street, 04-347 Warsaw									
type	MPW - 260					MPW - 260R				
mains voltage (L1+N+PE)	230V	100V	110V	120V	127V	230V	100V	110V	120V	127V
	±10%		±5%			±10%		±5%		
mains frequency,	50/60Hz		50Hz/60Hz			50Hz	60Hz	60Hz		
current protection [A]	T 4A		T 6,3A			T 10A				
cooling medium	-					R452A (CFC/HCFC free)				
	MPW - 260					MPW - 260R				
capacity (max.)	500 ml									
speed – RPM	90 ÷ 18000 rpm (step 1 rpm)									
force – RCF	24270 x g (step 1 x g)									
kinetic energy (max.)	8800 Nm									
running time	00:00:01 ÷ 99:59:59 – [hours, min., sec] (step 1s)									
time counting	since start button is pressed / since preselected speed is reached									
short-time operation mode – SHORT	yes									
continuous operation mode – HOLD	yes									
menu languages	Polish, English, German, Spanish, Italian, Portuguese, Russian, Swedish, French, Czech									
user programs	100									
adjustable temperature	-					-20 ÷ 40°C* (step 1°C)				
guaranteed temperature with max. rotor speed	-					≤4°C				
cooling/heating without centrifuging	no					yes/ no				
cooling/heating with centrifuging	no					yes /no				
acceleration (ACEL)	10 linear curves									
deceleration (DECEL)	10 linear curves									
programmable non-linear curves:										
acceleration	10									
deceleration	10									
USB communication	yes									
Electromagnetic compatibility	according to EN 61326-2-6:2006									
degree of protection	IP20									
height (H)	315 mm					315 mm				
width (W)	365 mm					365 mm				
depth (D)	495 mm					660 mm				
height with open cover (H _{oc})	620 mm					620 mm				
noise level	<60 dB									
power consumption	250W					600W				
weight 230V	approx. 23,1 kg					approx. 42,2 kg				
weight 120V	approx. 25 kg					approx. 44,3 kg				

*time and possibility of obtaining a set temperature is dependent on multiple factors, including rotor type, established RPM, ambient temperature, accuracy ±1°C, appropriate for place of temperature sensor

3.1 Environmental conditions

- The device may only be used indoors.
- The permissible ambient temperature is 2°C to 40°C.

- Maximum allowed relative humidity 80% at temperature up to 31°C decreasing linearly to 50% relative humidity at 40°C.
- The mains voltage fluctuations must not exceed $\pm 10\%$ of the nominal voltage.
- Maximum altitude 2,000 m above sea level.
- Overvoltage category II.
- Pollution degree 2.

4. Installation

Open the package. Remove the box containing the accessories. Take out centrifuge from the container. Keep the box and packing materials in case of service shipping.

4.1 Content of the package

name	pcs.	cat no.
centrifuge MPW-260/R	1	10260/2-56 10260/1-56 10260R/2-5 10260R/2-6 10260R/1-6 (type and supply version dependent)
complete clamp	1	17142
spanner for the rotor	1	17099T
spanner for emergency opening of the cover	1	18640
power cord – 230V / 120V	1	17866/17867
fuse WTA T 4A – 230V / WTA T 6,3A – 120V (for MPW-260)	2	17861 17862
fuse WTA T 10A – 230V / 120V (for MPW-260R)	2	17863
vaseline 20ml	1	17201
USB A-A cable	1	16655
user manual	1	See page 1.

4.2 Location

	<ul style="list-style-type: none"> ▪ The device is heavy, lifting and carrying the centrifuge may lead to back injuries. There is risk of injury when lifting and carrying heavy loads. ▪ The centrifuge should be lifted and transported with a sufficient number of helpers. Use a transport aid to transport the centrifuge. ▪ The appliance should be lifted from the bottom near the feet and placed directly on the appropriate lab bench. ▪ The centrifuge should be set so that access to the power switch is not difficult. ▪ A safe installation site must be provided. ▪ Do not place the centrifuge near heaters and avoid direct sunlight. ▪ The table on which the centrifuge is placed should be stable and have a flat, levelled top. ▪ Leave a distance of 30 cm around the centrifuge in order to maintain the ventilation zone, do not cover the ventilation openings (safety requirements in case of failure according to EN 61010-020). ▪ The laboratory table should be cleaned before placing the centrifuge on it.
---	---

	<ul style="list-style-type: none"> ▪ The given parameters of the centrifuge are maintained for the ambient temperature range given in the technical data table. ▪ When changing the place from cold to warm, water vapor condensation will occur inside the centrifuge. It is important to allow sufficient time for drying before restarting the centrifuge (min. 4 hours). ▪ The supply voltage must match the voltage specified on the rating plate. Laboratory centrifuges by MPW MED. INSTRUMENTS have a three-core connection cord with a plug resistant to dynamic loads. ▪ The power socket must have a safety pin. ▪ It is recommended to install an emergency switch located far from the centrifuge near the exit from the room or outside the room.
	<ul style="list-style-type: none"> ▪ Before switching on, check whether the centrifuge is connected to power supply correctly. It is obligatory to use only power cord recommended by manufacturer.

4.3 Current protection

	<p>The centrifuge is equipped with thermal current protection. Fuse is situated in the plug-in socket unit at back wall of the centrifuge.</p>
---	--



5. Safety notes

5.1 General remarks

	<ul style="list-style-type: none"> ▪ The laboratory centrifuge may be operated only by qualified laboratory personnel after getting acquainted with the user's manual. ▪ The operating instructions are part of the product. ▪ The instruction manual should always be kept near the centrifuge. ▪ The centrifuge cannot be operated inconsistently with its purpose. ▪ If the centrifuge is used in a manner inconsistent with the manufacturer's guidelines, the safety of the device operation may be impaired.
---	--

5.2 Filling the rotor

5.2.1 Angular rotors

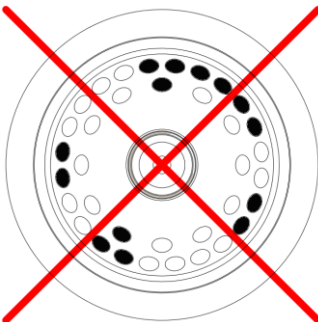
	<ul style="list-style-type: none"> ▪ Check that the rotor is properly seated and bolted to the motor axis. ▪ Do not exceed the maximum rotor load (information is provided on the rotors). ▪ In order to ensure symmetrical loading, fill opposite openings of the rotor with inserts and test tubes of the same type and weight. <div style="display: flex; justify-content: space-around; align-items: center;">   </div>
---	--

5.2.2 Horizontal rotors

- Check that the rotor is properly seated and bolted to the motor axis.
- Do not exceed the maximum rotor load.
- To ensure symmetrical and even rotor load, fill opposite slots with containers / hangers of the same type and weight.
- **Horizontal rotors must be filled with a complete set of containers / hangers.**
- Place test tubes symmetrically facing each other.
- Before starting centrifugation, check that all containers / hangers are properly hung and can swing freely.

Place empty test tubes in containers. Manually tilt the containers to the horizontal position, check that there are no collisions between the test tubes, containers / hangers and the rotor.

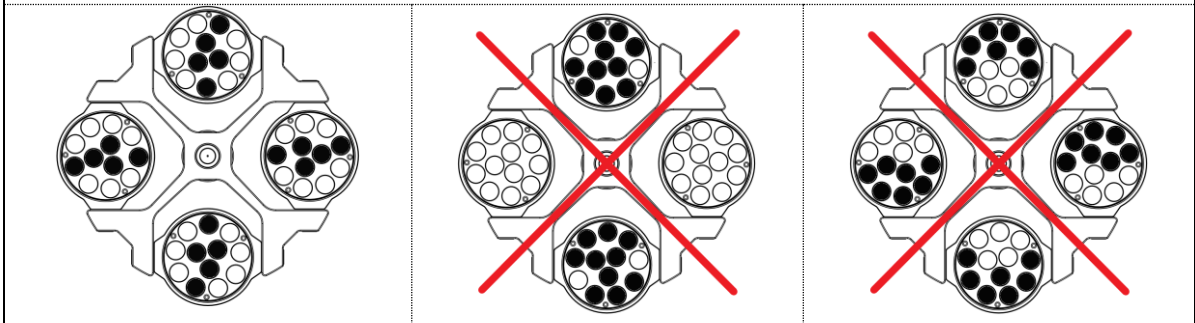

5.2.3 Filling tubes

- **Tubes may only be filled outside the centrifuge.**
- Tubes may only be filled with the maximum amount of substance specified by the manufacturer.
- The test tubes must be filled in such a way that the centrifuged substance does not run out of the vessel during centrifugation.

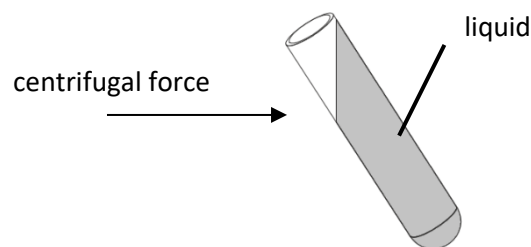



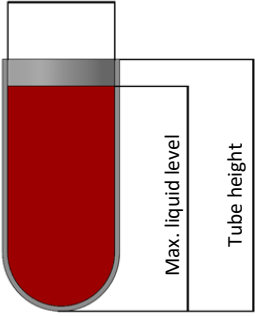

- In case the tube manufacturer has not specified a maximum level, fill the tubes according to the formula:







$$\text{Max liquid level} < \text{Tube height} - \frac{\text{Internal tube diameter}}{2}$$

	<p>Internal tube diameter</p> 
	<ul style="list-style-type: none"> ▪ For centrifugation in the centrifuge, only containers included in the list of equipment and centrifuge tubes, the diameter, length and strength of which are appropriate, should be used. The use of test tubes from other manufacturers should be agreed with MPW MED. INSTRUMENTS or its authorized representatives. ▪ Pay attention to the quality and appropriate thickness of the walls of glass test tubes. Glass tubes should be centrifuge tubes. ▪ To prevent the centrifuge from being unbalanced, it is recommended to weigh the filled test tubes before inserting them into the rotor. When centrifuging in horizontal rotors, it is recommended to weigh the filled containers / hangers. This will allow to minimize the differences in mass between them, which will positively affect the suspension of the engine and the reduction of noise level during the operation of the centrifuge.

5.3 Safety hints

	<p>ROTORS MAINTENANCE</p> <ul style="list-style-type: none"> ▪ Lubricate the swing-out rotor journal pins. ▪ Use only accessories in good condition. ▪ Protect equipment against corrosion using accurate preventive maintenance.
	<p>HS ACCESSORIES MAINTENANCE</p> <ul style="list-style-type: none"> ▪ Make sure that rubber O-rings are lightly coated with silicone grease. Use high vacuum grease, e.g., type „C” by LUBRINA.
	<p>HAZARDOUS MATERIALS</p> <ul style="list-style-type: none"> ▪ MPW accessories are not biotight. For centrifuging infectious materials, it is necessary to use hermetically closed tubes meeting demands of biotightness, in order to prevent germs migration into the centrifuge and beyond it. ▪ It is not allowed to subject to centrifugation toxic or infectious materials with damaged leak proof seals of the rotor or test-tube. Proper disinfection procedures have to be carried out when dangerous substances contaminated the centrifuge or its accessories.
	<p>EXPLOSIVE AND COMBUSTIBLE MATERIALS</p> <ul style="list-style-type: none"> ▪ It is not allowed to centrifuge explosive and inflammable materials. ▪ It is not allowed to centrifuge substances prone to reacting in result of supplying high energy during centrifugation. The centrifuge cannot be operated in explosion-endangered areas. ▪ It is not allowed to centrifuge materials capable of generating inflammable or explosive mixtures when subjected to air.

5.4 Operating conditions



	<p>START-UP</p> <ul style="list-style-type: none"> ▪ Prior to switching the centrifuge on, one shall carefully read all sections of this user manual in order to ensure smooth operation and avoid damages of this device or its accessories. ▪ In order to protect the centrifuge against unbalance, fill in the test tubes up to the same weight.
	<p>TRANSPORTATION</p> <ul style="list-style-type: none"> ▪ Centrifuge must not be transported with the rotor mounted on the shaft.
	<p>GENERAL HINTS</p> <ul style="list-style-type: none"> ▪ One must use original rotors, tubes and spare parts only. ▪ In case of faulty operation of the centrifuge one shall ask for assistance of service of MPW MED. INSTRUMENTS company or its authorized representatives. ▪ It is not allowed to switch the centrifuge on if it is not installed properly or rotor is not fitted correctly.
	<p>CENTRIFUGED SUBSTANCES</p> <ul style="list-style-type: none"> ▪ It isn't allowed to exceed load limit set by the manufacturer. Rotors are intended for fluids of average homogeneous density equal to 1,2 g/cm³ or smaller when centrifugation is carried out at maximum speed. When fluids of higher density shall be used, then it is necessary to change density of centrifuges sample in PARAM/DENSITY field. ▪ Observe the limitation on the permissible mass specified on the rotor/ bucket (eg MAX 15g). If the designation is given on the rotor, it refers to the mass of the sample. If the designation is given on the bucket, it refers to the mass of the entire load, i.e. adapter+ tube + sample. <p>Examples:</p> <div style="display: flex; justify-content: space-around; align-items: flex-start;"> <div style="text-align: center;"> <p>Rotor</p>  <p>2,4g – maximal mass of tube content</p> </div> <div style="text-align: center;"> <p>Bucket</p>  <p>290g – maximal mass of elements inside bucket</p> </div> </div>

5.5 Equipment life

	<ul style="list-style-type: none"> ▪ Each spin cycle during which the rotor has accelerated and decelerated is considered a duty cycle, regardless of the speed and its duration. ▪ Do not use the equipment after the allowable number of cycles or when the maximum service life has passed, whichever comes first.
--	---

5.6 Work safety

The centrifuge must be inspected by an authorized service provider at least once a year (after the warranty period). For example, the corrosive environment may be the reason for more frequent control. The tests shall be completed by issuing a validation protocol specifying checks on the technical condition of the laboratory centrifuge. It is recommended that you set up a document that records any repairs and inspections. Both of these documents should be stored at the place of use of the centrifuge.

	<p>INSPECTION PROCEDURES CARRIED OUT BY THE OPERATOR</p> <p>Operator has to pay special attention to the fact that the centrifuge parts of key importance due to safety reasons are not damaged. This remark is specifically important as for:</p> <ul style="list-style-type: none"> ▪ Centrifuge accessories and especially structural changes, corrosion, preliminary cracks, abrasion of metal parts. ▪ Screw connections. ▪ Inspection of seals of the buckets if such are used. Special attention must be paid to all of the rubber (seals) parts. In the case of damage or visible structural changes defective parts must be replaced for new immediately (Set of seals Cat. No. 18591 available from the manufacturer). ▪ Control of execution of the guarantee yearly technical inspection of the centrifuge (after lapse of guarantee).
	<ul style="list-style-type: none"> ▪ Only the manufacturer-specified buckets, included in the equipment list, as well as centrifuge tubes, which diameter, length and durability are suitable, should be used for spinning in this centrifuge. The use of equipment made by other manufacturers should be consulted with the manufacturer of the centrifuge. ▪ It is not allowed to lift or shift the centrifuge during operation, and rest on it. ▪ It is not allowed to stay in the safety zone within 30 cm distance around the centrifuge neither leave within this zone some things, e.g., glass vessels. ▪ It is not allowed to put any objects on the centrifuge.
	<p>COVER OPENING</p> <ul style="list-style-type: none"> ▪ It is not allowed to open the cover manually in emergency procedure when rotor is still turning.
	<p>ROTORS</p> <ul style="list-style-type: none"> ▪ It is not allowed to use the rotors and round carriers with signs of corrosion or other mechanical defects. ▪ It is not allowed to centrifuge highly corrosive substances which may cause material impairment and lower mechanical properties of rotor and round carriers. ▪ It is not allowed to carry out centrifugation with the rotor caps taken off or not driven tight.

5.7 Unbalance

The centrifuge is provided with the rotor unbalance sensor and when it will be activated, centrifugation process will be stopped through fast braking and at the same time an error message will be displayed. Cancellation of this error is possible only through pressing **BACK, STOP, COVER, SET** or **▲▼◀▶** key after stopping of the rotor.

One must check if rotor was correctly loaded, close the cover and once more start the program. In order to protect the rotor against improper work, it has to be provided with identically filled buckets, carriers, test-tubes etc. for getting the best balance possible (see section **Loading the rotor**).

Then close the cover and restart the program.

	<p>Unbalance causes noise and vibrations during operation, and adversely affects power transmission system (motor, shock absorbers). The better balance, the smoother will be the centrifuge operation and therefore longer life of usage of the driveline. Moreover, the ideal separation level is then obtained, as already separated constituents would not be moved up by vibration.</p>
---	--

5.8 Emergency stops

In any moment of centrifuging, it is possible interrupt the process and fast stop the rotor. Single time pressing of the **STOP** key will make centrifuging stop with acceleration characteristics set in the program (after pressing the **SET** or **STOP** key, the device returns to the main screen). Pressing and holding it up to 1s will make the centrifuging stop with the strictest characteristic.

5.9 Residual risk

The centrifuge is built according to the state-of-the-art and the recognized safety regulations. Nevertheless, still remain some level of residual risk due to improper operation and malfunctions. It is possible to decrease residual risk by strictly applying user manual conditions and correcting malfunction which could threaten safety, immediately.

6. Operating

6.1 Centrifuge overview

New generation of MPW MED. INSTRUMENTS laboratory centrifuges is provided with state-of-the-art microprocessor control systems, very durable and quiet asynchronous brushless motors and accessories consistent with requirements of the present-day user.

6.2 Centrifuge description

1. Power switch
2. USB
3. Control panel
4. Cover
5. Inspection glass
6. Point of emergency lid opening

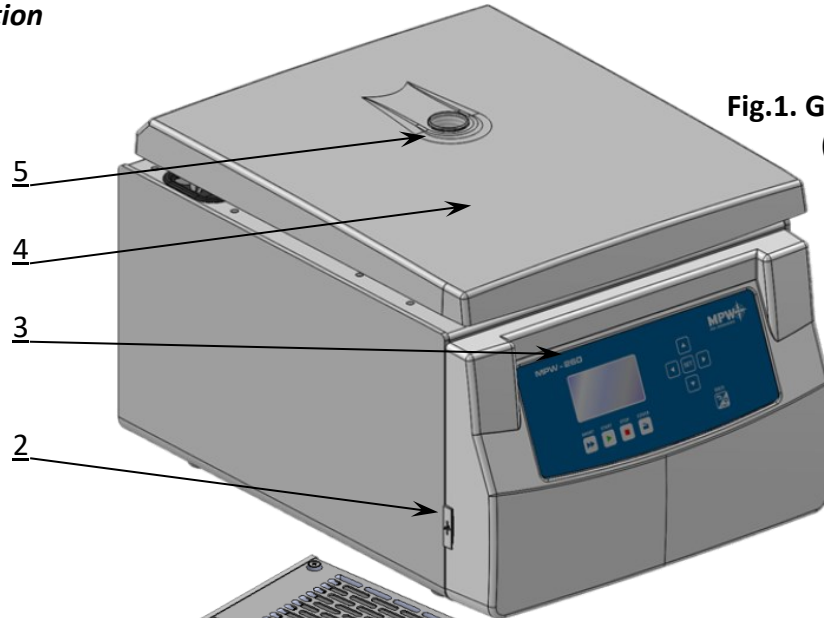

Fig.1. General view (MPW-260)

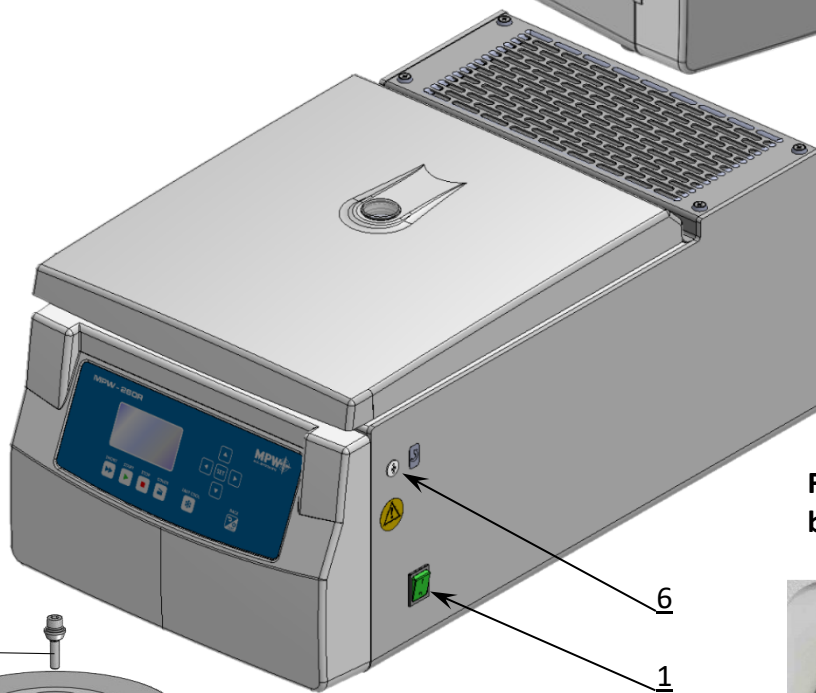
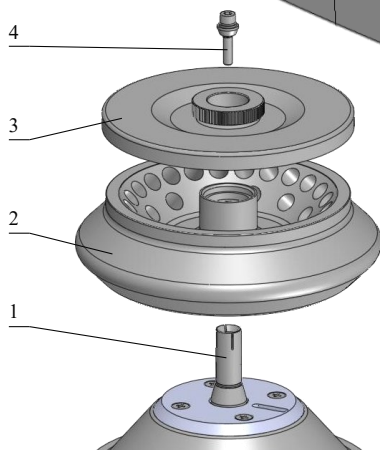

Fig.2. Right side of centrifuge (MPW-260R)



1. Motor axle
2. Rotor
3. Rotor lid
4. Complete clamp

Fig.3. Assembly of angle rotor

Fig.4. Mains socket back of the centrifuge

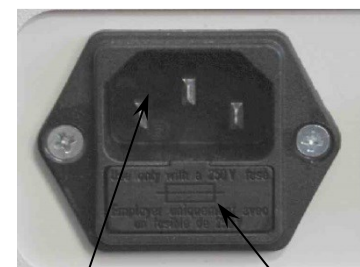

1. Plug-in socket
2. Fuse socket

6.3 Construction

The centrifuge has rigid self-supporting structure. Housing was made of sheet of aluminum, back made of steel sheet. Front and cover were made of ABS type plastic. Cover is fixed on steel axles of hinges and from the front it is locked with electromagnetic lock blocking possibility of opening during centrifugation. The rotation chamber is made of stainless-steel sheet.

6.4 Name plate

The data concerning the device should be read from the rating plate located on the rear wall of the centrifuge (the picture below is an example).

1	Centrifuge model	9	Rated frequency
2	Catalog number	10	Current protection
3	Maximum speed	11	Manufacturer's logo
4	Rated voltage	12	Approval marks and symbols (explained in chapter 1)
5	Maximum rated power	13	QR code for serial number
6	Serial number	14	Information about the refrigerant (refrigerated centrifuges only)
7	Date of production		
8	Manufacturer data		

6.5 Rotor and accessories installation

	<ul style="list-style-type: none"> ▪ Connect the centrifuge to the power source (mains socket at the back of the centrifuge). ▪ Turn on the centrifuge (switch on the side of the centrifuge). ▪ Open the cover of the centrifuge by pressing the COVER key. Before installing the rotor, check that the centrifugation chamber is free from contamination, e.g., dust, glass splinters, liquid residues that must be removed. ▪ Put the rotor on the motor axis by sliding it onto the cone as far as it will go (keeping the coaxially between the rotor and the motor axis). ▪ Screw the clamp into the motor shaft (clockwise), then tighten it firmly with the rotor wrench. ▪ Swinging rotors must be equipped with buckets in all seats. ▪ Container suspension pins should be regularly lubricated with technical petroleum jelly. ▪ In the case of rotors with a cover, they must not be used without the cover. Rotor caps must be screwed securely onto the rotor. The rotor and cover are marked with the same catalog number (REF) to eliminate the risk of incorrect selection when the
--	---

	<p>user has several types of rotors. Rotor covers ensure lower rotor resistance, correct tube seating and airtight sealing.</p> <ul style="list-style-type: none"> ▪ Only containers suitable for the selected type of rotor should be used. ▪ In order to increase the durability of the rotor and seals, it is recommended to lubricate the rotor pins used to suspend the containers, the undercuts for the pins in the containers, gaskets and threaded places with technical petroleum jelly. ▪ In order to replace the rotor, remove the tubes and containers, loosen the rotor clamp with the provided wrench, counterclockwise, and then use both hands to grasp the rotor on opposite sides and remove it from the motor axis by pulling it upwards.
	<p>It is recommended to equalize vessels loads as much as possible in order to ensure minimal vibrations during operation.</p>

6.6 Control device

The microprocessor control unit of the centrifuge ensures broad possibilities of providing, realization and reading of work parameters.

6.7 Setting parameters

Data setting and read-out system forms hermetically closed keyboard with distinctly accessible operation points. Easily readable displays signaling individual performed operations facilitate operator's programming and recording of parameters and condition of the centrifuge. The centrifuge is provided with the USB interface that enables connection of the centrifuge to external PC unit with the printer and recording the centrifugation parameters.

6.8 Safety features

Cover lock

The centrifuge can be started only with properly closed cover. While the cover can be opened only after stopping the rotor. In case of emergency opening of the cover during operation, the centrifuge drive will be immediately switched-off and the rotor will brake till complete stopping.



Unbalance detecting

When loads of opposite buckets or carriers in rotors are unbalanced, the drive will be switched-off during acceleration or operation of the centrifuge – and the error message will be displayed.

Rotor verification and checking compatibility with loaded program

Directly after starting centrifuging, a unit verifies the type of the rotor applied and in the case of its incompatibility with the type indicated in the application or absence of the rotor, the spinning process shall be stopped with simultaneous displaying the error message. The conformity of the type of the rotor is signaled with a single audible signal. In case auto identification (see "9.8 Other") option is checked, proper rotor will be automatically chosen, without user engagement.

Rest state inspection

Opening of the centrifuge's cover by **COVER** button is possible only when the rotor is in the state of rest. Check if the symbol , is visible on the screen. Use inspection glass in cover for be sure if rotor is in the rest state. When the rotor is being stopped, braking symbol  or  (see chapter "Display") is visible and goes off when it is stopped. Emergency cover opening during rotor running is prohibited.

Checking of excessive temperature (MPW-260R)

If temperature in rotation chamber exceeds 50°C caused by, for example, malfunction of cooling system, drive will be switched off and error message will be displayed. The reboot is only possible after chilling device.

6.9 Increase in temperature (MPW-260 only)

In uncooled centrifuges, the temperature in the rotor chamber, rotor and sample can increase to above 40°C, based on the run time, g-force (RCF)/speed and ambient temperature.

7. Centrifuging

Power switching ON/OFF is carried out with master switch situated on the right-side wall of the centrifuge. All settings on the centrifuge are done by means of the control panel.

7.1 Control panel

The control panel placed on the front casing serves the purpose of controlling centrifuge operation.

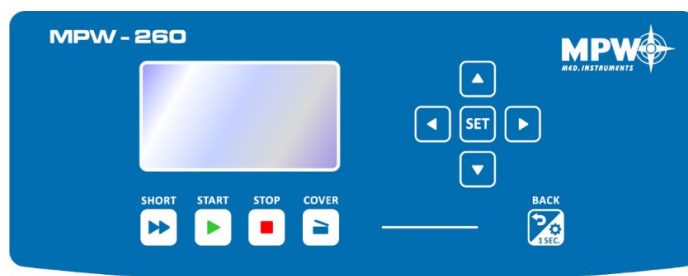

Control panel MPW-260

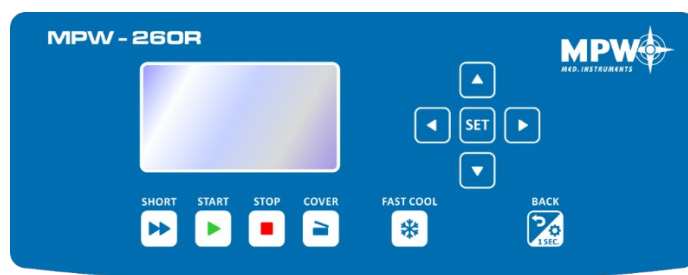

Control panel MPW-260R

	SHORT ¹	short-time centrifuging
	START	start centrifugation run
	STOP ²	end centrifugation run
	COVER	cover opening
	FAST COOL	start fast cooling mode (MPW-260R only)
	BACK/ OPTIONS	exit the current menu / enter to submenu of options (keep held down within 1 s.)
	UP	navigation in menu / increasing values
	DOWN	navigation in menu / decreasing values
	LEFT	navigation in menu
	RIGHT	navigation in menu
SET	SET	changing parameters / confirming changes

¹ the centrifuge is working as long as the key is pressed

² first-time pressing press – will make stopping centrifuging with acceleration characteristics set in the current program,
second-time pressing – will make stopping the centrifuging as fast as possible (quickest characteristic) (after stopping the rotor, the message can be cancelled by pressing any key except **SHORT**, **START** and **COVER** – if cover is open)

7.2 Display

The display is located in the center of the control panel. The main screen variants are presented below. In this chapter are shown exemplary screens for MPW-260R centrifuge (screens for MPW-260 – without cooling – do not include temperature field). Highlighting of field on display means it is selected and ready to set.

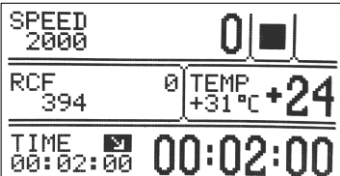



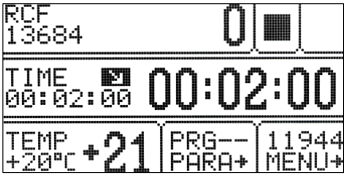



	<p>After switching on centrifuge, welcome screen appears. After disappearing the welcome screen, it is possible to setting up parameters.</p>
	<p>Simplified display mode is set as default, there is possible to switch to normal (see chapter <i>Types of main screen</i>).</p>

















Normal display contains an expanded number of settings visible during operation.

RPM display mode	RCF display mode
	

- Detailed information on display modes is provided in chapter “Types of main screen”.

SPEED	rotor speed	assigned/measured
RCF	relative centrifugal force	assigned/measured
TIME	centrifuging time	assigned/measured
TEMP	temperature	assigned/measured
PRG	program no.	
11199	rotor no.	
PARAM	parameters of the centrifuge	
MENU	configuration menu	

	changing values		
	user multi sections curve		
	density > 1,2 g/cm ³		
	centrifuging radius changed		
	counting time down (decreasing)		counting time up (increasing)
	cooling to assigned temperature		
	FAST COOL mode cooling		

	centrifuging		centrifuging (with automatic cover opening)
	rotor stopped / closed cover		rotor stopped / opened lid
	braking		fastest decelerating
	rotor identification		
	thermal chamber		
	temperature delay		
	time delay		
	drop-down list		
	temporarily disabled		
	locked		
	time counting (blinking)		
	disabled option		active option

7.3 Setting up RPM, RCF, time, temperature



On the main screen, it is possible to set:

rotating speed - RPM	SPEED
relative centrifugal force (multiple of g-force)	RCF
centrifuging time	TIME
centrifuging temperature	TEMP (only MPW-260R)



Exemplary change of **SPEED** setting:





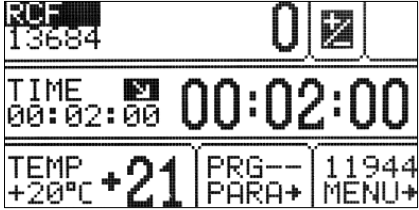

The screenshot shows the main screen with the following settings: SPEED is set to 0 (with a checkmark icon), TIME is 00:02:00, and TEMP is +21°C. At the bottom, there are menu options: PRG--, 11944, PARA+, and MENU+.

- Press **SET** (to enter edit mode) –  appears.
- Via **▲▼◀▶** keys mark **SPEED** field (blinking).
- Press **SET**  blinking.
- Via **◀▶** choose order of magnitude of changing value (blinking).
- With **▲▼** choose demanded value.
- Repeat above two steps for other orders of magnitude.
- Confirm settings by pressing **SET**.
- Press **BACK**.



▪ When RPM is changed, RCF is automatically corrected.

Exemplary change of RCF setting:	
	<ul style="list-style-type: none"> ▪ Press SET (to enter edit mode) –  appears. ▪ Via ▲▼◀▶ keys mark RCF field (blinking). ▪ Press SET -  blinking. ▪ Via ◀▶ choose order of magnitude of changing value (blinking). ▪ With ▲▼ choose demanded value. ▪ Repeat above two steps for other orders of magnitude. ▪ Confirm settings by pressing SET. ▪ Press BACK.
<ul style="list-style-type: none"> ▪ When RCF is changed, RPM is automatically corrected. 	
<ul style="list-style-type: none"> ▪ When setting the speed value, setting "hundreds" or "thousands" resets the "units" and "tens". 	



Exemplary change of TIME setting:	
	<ul style="list-style-type: none"> ▪ Press SET (to enter edit mode) -  appears. ▪ Via ▲▼◀▶ keys mark TIME field (blinking).
<p style="text-align: center;">00:02:00 [hh : mm : ss]</p> <p>e.g.: centrifuging time – 2 minutes 00 seconds</p>	<ul style="list-style-type: none"> ▪ Press SET -  blinking. ▪ Via ◀▶ choose order of magnitude of changing value (blinking). ▪ With ▲▼ choose demanded value. ▪ Repeat above two steps for other orders of magnitude. ▪ Confirm settings by pressing SET. ▪ Exit edit mode by pressing BACK.
00:02:00	set value
02:00	current value (most significant digits)

HOLD mode – continuous run mode	
	<ul style="list-style-type: none"> ▪ To run centrifuging in HOLD mode set 00:00:00 time. ▪ To end centrifuging in HOLD mode press STOP.

Exemplary change of **TEMP** setting (only MPW-260R):



	<ul style="list-style-type: none"> Press SET (to enter edit mode) –  appears. Via ▲▼◀▶ keys mark TEMP field (blinking). Press SET key. With ▲▼ choose demanded value [-20°C÷40°C]. Confirm settings by pressing SET. Press BACK.
---	--

7.4 User's programs

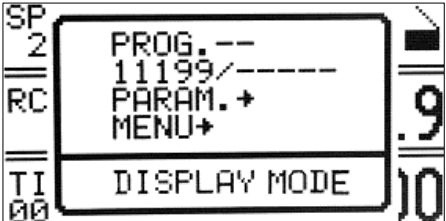

	<p>After switching centrifuge on, program that was used in previous session is being loaded. If any program was not used in previous session, centrifuge resume the last chosen parameters.</p>
	

Program choosing:

Entering the program selection mode for the simplified display:

	<ul style="list-style-type: none"> Press and hold  by 1 second. Choose PROG with ▲▼ Press SET.
---	--

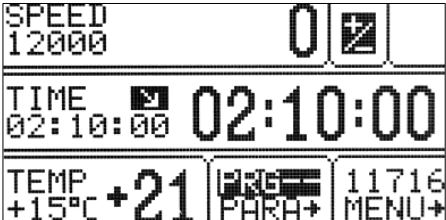
Entering the program selection mode for the normal display:

	<ul style="list-style-type: none"> Press SET key –  appears. Via ▲▼◀▶ keys mark PRG -- field (highlighted) Press SET key – list of programs is visible.
---	--

Program selection mode tab:

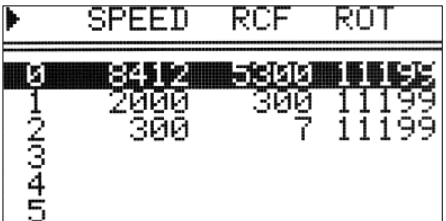
	<ul style="list-style-type: none"> Via ▲▼ choose demanded program. Confirm with SET key.
---	--

	<p>LOAD, SAVE, DELETE, CURVES, NEW PROGRAM refer chosen program which is marked by ▸.</p> <p>▸ – currently chosen program.</p>
	<ul style="list-style-type: none"> ▪ LOAD – load selected program
	<ul style="list-style-type: none"> ▪ SAVE – save settings as a program (confirm by selecting YES and pressing SET)
	<ul style="list-style-type: none"> ▪ DELETE – delete program (confirm by selecting YES and pressing SET)
	<ul style="list-style-type: none"> ▪ CURVES – creating characteristics
	<ul style="list-style-type: none"> ▪ NEW PROGRAM – creating new program

<p>NEW PROGRAM – enter to create new program mode (as below)</p>	
<p>Creating a new program:</p>	
	<ul style="list-style-type: none"> ▪ Press SET key. ▪ Via ▲▼◀▶ keys mark PRG -- field (blinking). ▪ Press SET key. List of programs is visible, choose demanded position (number of program). ▪ Press SET key- menu of program settings will appear. ▪ Choose NEW PROGRAM press SET and BACK, and then set demanded parameters of centrifuging (look chapter “6. Centrifuging”). ▪ In case you want to register new program, back to the PRG -- menu and save it as described before.

Changing parameters during centrifuging:

- There is a possibility to change parameters: **SPEED, RCF, TIME, TEMP** during centrifuging. Such modifications inactivate currently running program. When program was set, modification during run is represented by **PRG --** symbol (instead of the program number).

7.5 Creator of acceleration and deceleration curves

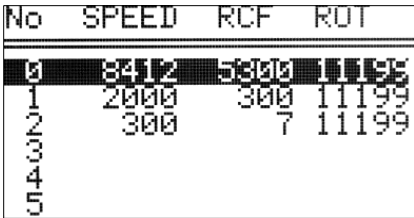
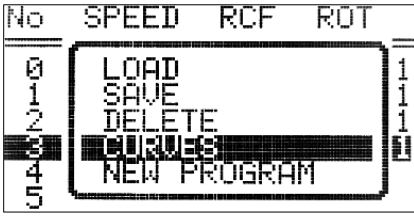
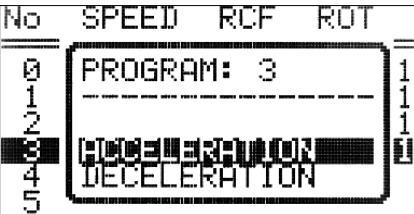
		PROG/CURVES
	<ul style="list-style-type: none"> With ▲▼ keys choose saved program for which you intend to create the acceleration or deceleration characteristics (marked with symbol ▶). 	
	<ul style="list-style-type: none"> Press SET. With ▲▼ keys choose CURVES. Press SET - the selection frame is displayed. 	
	<ul style="list-style-type: none"> With ▲▼ keys choose ACCELERATION to create acceleration characteristics or DECELERATION to create deceleration characteristics Confirm selection by pressing SET. 	

7.5.1 Acceleration characteristic, creation of episode 1

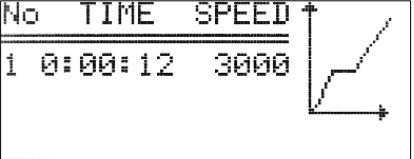
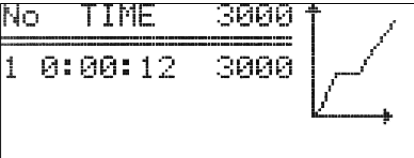
<p>Displayed alternately SPEED and 3000 (example):</p>  	No	section no. (max. 4)
	TIME	total acceleration time
	SPEED	final RPM
	ACC	characteristic's no. (10-19)
		adding a new section
		deleting last section
		editing sections
		exiting from characteristics wizard
		switching RPM/RCF
		entering graph view

After entering the curve wizard, the symbol is highlighted. Pressing **SET** and selecting "NO" in response to the question "SAVE?" will return to the **PROG → CURVES** menu without making changes to the starting characteristics. To start editing the one-segment characteristics, select the icon with the ◀▶ keys and press the **SET** key.

		editing value (flashing means editing the given value)
<ul style="list-style-type: none"> ▪ Press SET ▪ With ▲▼◀▶ choose time for section ▪ Press SET ▪ It is not possible to edit the maximum speed value. To do this, more sections have to be created, but the last section will always have the maximum set speed and cannot be changed. ▪ Select ↻ with ▼◀ buttons and press SET to finish editing characteristics. 		

7.5.2 Adding and editing sections - acceleration

To program next sections, select the ⊕ icon with the ◀▶ buttons and press **SET**. A new section (sections) will appear with a time of 1 second and a speed equal to the maximum speed.

To start editing a newly added section (sections), select the ✎ icon with the ◀▶ buttons and press **SET**, and follow the instructions given below.

After entering the profile section editing menu, the time value of the first section will be highlighted (see the picture below).

	The maximum speed value for the section cannot be higher than the maximum speed value for the characteristic (for the last section).
<ul style="list-style-type: none"> ▪ With ▲▼◀▶ highlight time or speed for desired section ▪ Press SET ▪ With ▲▼◀▶ choose value ▪ Press SET ▪ Repeat until setting all the sections ▪ To finish editing characteristic with ▲▼◀▶ choose ↻ and press SET. Finishing edition can be also done by pressing BACK button. 	

Saving created characteristic

	<ul style="list-style-type: none"> ▪ Select the ↻ icon with the ◀▶ buttons and press SET ▪ In the "Save?" window, use ▲▼ buttons to select YES to confirm saving the characteristic or NO, to exit without saving ▪ Press SET
--	--

7.5.3 Acceleration graph

An example of given parameters and a diagram:

No	TIME	SPEED
1	0:00:30	2000
2	0:00:52	6000
3	0:01:10	6000
4	0:02:00	9000



After the time value programming is completed, the **TIME + SPEED** segment of the user's startup characteristic can be displayed graphically. The set section of the characteristic curve is illustrated on the graph, which can be displayed by selecting the icon  with the ◀▶ keys and pressing the **SET** key.

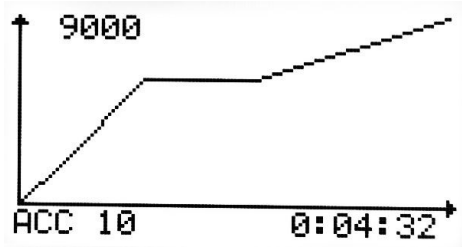

7.5.4 Deceleration characteristic, creation of episode 1

SPEED or **3000** displayed (example):

No	TIME	SPEED
1	0:00:15	0









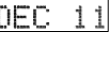

No	TIME	SPEED
1	0:00:15	0





No	TIME	SPEED
1	0:00:15	0



No	section no. (max. 4)
TIME	total acceleration time
SPEED	final RPM
DEC	characteristic's no. (10-19)
	adding a new section
	deleting last section
	editing sections
	exiting from characteristics menu
	switching RPM/RCF
	entering graph view

After entering the curve wizard, the symbol  is highlighted. Pressing **SET** and selecting "NO" in response to the question "SAVE?" will return to the **PROG → CURVES** menu without making changes to the starting characteristics. To start editing the one-segment characteristics, select the icon  with the ◀▶ keys and press the **SET** key.

	editing value (flashing means editing the given value)
<ul style="list-style-type: none"> Press SET With ▲▼◀▶ choose time for section Press SET To edit speed 	



	<ul style="list-style-type: none"> It is not possible to edit the minimum speed value. To do this, more legends must be created, but the last leg will always be "0". Select  with \blacktriangledown \blacktriangleleft buttons and press SET to finish editing characteristics
--	--

7.5.5 Adding and editing sections - deceleration

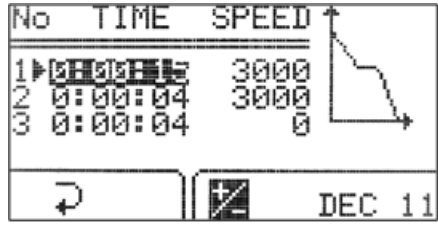

In order to program successive periods, select the icon  with the \blacktriangleleft \blacktriangleright keys and press the **SET** key. A new segment (or segments - after successive presses of SET) will appear with the time and speed equal to the minimum speed - "0".

To start editing the newly added sections, select the icon  with the \blacktriangleleft \blacktriangleright buttons, press **SET** and make the settings as described below.

After entering the profile section editing menu, the time value of the first section will be highlighted (see the picture below).

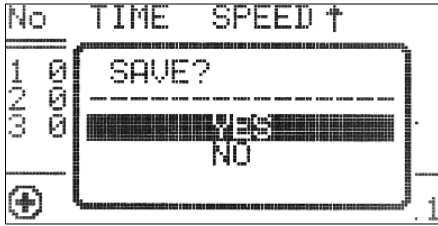

	<p>The speed value of the last segment will always be "0".</p> <ul style="list-style-type: none"> With \blacktriangle \blacktriangledown \blacktriangleleft \blacktriangleright highlight time or speed for desired section Press SET With \blacktriangle \blacktriangledown \blacktriangleleft \blacktriangleright choose value Press SET Repeat until setting all the sections To finish editing characteristic with \blacktriangle \blacktriangledown \blacktriangleleft \blacktriangleright choose  and press SET. Finishing edition can be also done by pressing BACK button
--	--

SAVING CREATED CHARACTERISTIC

	<ul style="list-style-type: none"> Select the  icon with the \blacktriangleleft \blacktriangleright buttons and press SET In the "Save?" window, use \blacktriangle \blacktriangledown buttons to select YES to confirm saving the characteristic or NO, to exit without saving Press SET
---	---

7.5.6 Deceleration graph

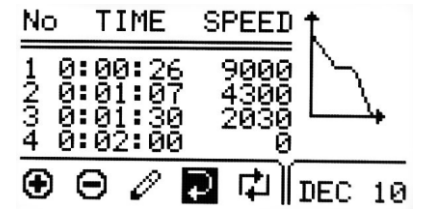
An example of given parameters and a diagram:

	<p>After programming the time value, you can graphically display the TIME + SPEED segment of the user's braking characteristic. The set section of the characteristic curve is illustrated on the graph, which can be displayed by selecting the icon  with the \blacktriangleleft \blacktriangleright keys and pressing the SET key.</p>
---	--

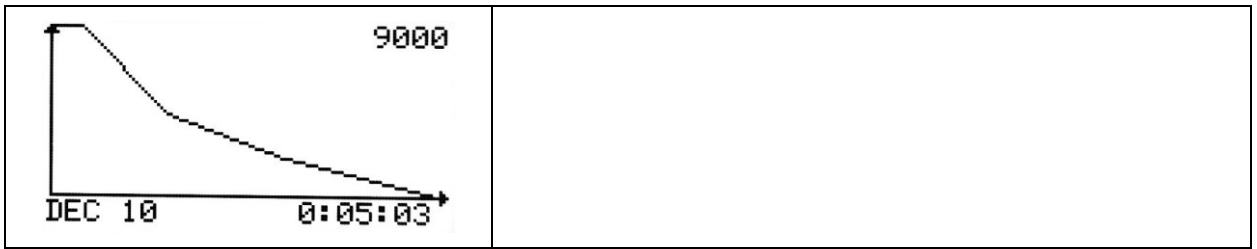

7.5.7 Deleting sections

In the characteristic's wizard:

	<ul style="list-style-type: none"> ▪ Select the icon with the buttons and press SET ▪ In the "Delete?" window, use buttons to select YES to confirm deleting the characteristic section or NO to cancel ▪ Press SET
--	---

7.6 Programs with user characteristics

Loading a modified program in the **CURVES** fold is signaled by the icon on the main screen:

	<p>Icon signals that program with user acceleration/deceleration characteristics are loaded.</p>
--	---

A change in any parameter entails the deactivation of the multi-section's curves mode.

7.7 Rotor and bucket choosing



Simplified display mode	
	<ul style="list-style-type: none"> ▪ Press and hold by 1 second. ▪ Choose rotor number (exemplary 11199/-----) with . ▪ Press SET. ▪ Execute points described follow (below Normal display mode description)
Normal display mode	
	<ul style="list-style-type: none"> ▪ Press SET— appears. ▪ Via mark rotor choosing field. ▪ Press SET (Rotors and buckets list will appear).

<pre> ROTOR BUCKET SPEED 11199 ----- 15000 11461 ----- 15000 11716 ----- 15000 11760 ----- 14000 11942 ----- 6000 11943 ----- 15000 </pre>	<ul style="list-style-type: none"> Via ▲▼ keys mark demanded rotor number Confirm by pressing SET. If a bucket can be selected: <ul style="list-style-type: none"> With ▲▼ select demanded bucket number. Press SET. Press BACK to close edition mode.
<pre> RCF RMAX RMIN 16854 67 40 20879 83 40 17608 70 40 20160 92 40 3542 88 50 21382 85 51 </pre>	<ul style="list-style-type: none"> With ◀▶ keys one may switch between screens of rotors parameters
<ul style="list-style-type: none"> It is possible to set AUTOMATIC ROTOR IDENTIFICATION. The procedure is described in subsection <i>Other</i>. 	

7.8 SHORT mode

SHORT MODE – short work mode (centrifuging with pressed SHORT key)	
	<ul style="list-style-type: none"> The SHORT mode is activated by pressing and holding ►►(SHORT). In SHORT mode the centrifuge is working as long as the SHORT key is pressed or when set time is over. Centrifuging is stopped after releasing the SHORT key.

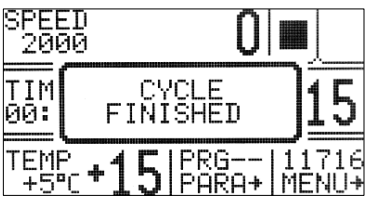
7.9 Finishing the centrifuging

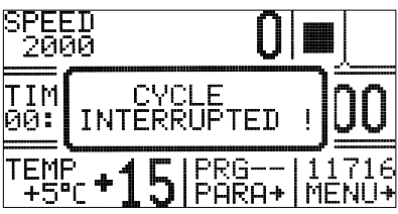
<ul style="list-style-type: none"> When preselected time is reached, centrifugation will end automatically. 	
	
 <p>x1</p>	<ul style="list-style-type: none"> Before lapsing preselected time, one may stop centrifugation. Pressing STOP for the first time will stop centrifuging with the characteristic set-in loaded program. ↓ symbol will be shown.
 <p>x2</p>	<ul style="list-style-type: none"> Pressing STOP second time will stop centrifuging with the fastest characteristic. ↓ symbol will be shown.
	
<ul style="list-style-type: none"> The message about cancel of centrifuging can be delete with the STOP, SET, COVER, ▲▼◀▶ or BACK key. 	

7.10 Temporarily disabled functions

Functions written below can be temporarily disabled.





active	SPEED	RCF	TIME	TEMP	PROG —	— / — —	PARAM	MENU
THERMAL CHAMBER	•	•	•	○	•	•	•	•
STANDARD CENTRIFUGING	•	•	•	•	•	○	•	○

- available
- disabled

8. Temperature control

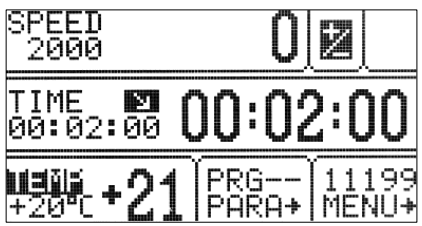

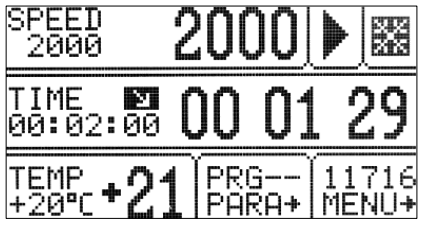
	MPW-260R only
---	---------------

Centrifuge is equipped with ecological refrigerating system with temperature control. During centrifugation, there may appear differences in temperature on the display and temperature of the samples in the rotor. It depends on thermal conductivity of the rotor, and samples and centrifugation time, initial temperature of rotor and samples.

Exemplary change of TEMP setting:	
	<ul style="list-style-type: none"> ▪ Press SET (to enter edit mode)  – appears. ▪ Via ▲▼◀▶ keys mark TEMP field (highlighted). ▪ Press SET key. ▪ With ▲▼ choose demanded value (from -20°C to 40°C). ▪ Confirm settings by pressing SET. ▪ Press BACK.
	Cooling is indicated by a symbol  (blinking).

8.1 Initial cooling during centrifuging –FAST COOL

	<ul style="list-style-type: none"> ▪ The parameters allowable to change at FAST COOL mode: <ul style="list-style-type: none"> ▫ temperature (lower than current temperature shown by centrifuge) ▪ In order to centrifuging reduced temperature samples (e.g., storage in the external refrigerator) centrifuge chamber, rotor and centrifuge container must be pre-cooling to the predetermined temperature. It causes minimalization of temperature differences. ▪ Initial cooling may be activated by FAST COOL key (lid must be closed – rotor is spinning at FAST COOL mode) ▪ When FAST COOL mode is active, cooling system automatically set proper parameters to obtain demanded temperature the fastest way.
---	---

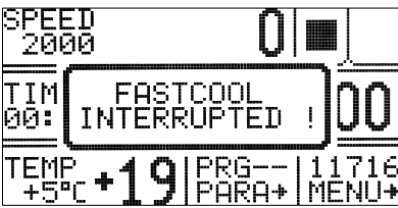
	<p>FAST COOL mode is marked by symbol  blinking in the right upper side of display.</p>
	<p>It is possible to exit FAST COOL mode at any time by pressing STOP key.</p> <p>Interruption of the function is signaled by a message.</p>

8.2 Initial cooling without centrifuging – THERMAL CHAMBER

	<p style="text-align: right;">PARAM → THERMAL CHAMBER</p> <ul style="list-style-type: none"> There is possible to run centrifuge in THERMAL CHAMBER mode – cooling (rotor is at standstill). How to enable THERMAL CHAMBER is described in “Thermal chamber” chapter.
---	--

8.3 Cooling in “START DELAY – OF TEMPERATURE” mode

	<p style="text-align: right;">PARAM → START DELAY – OF TEMPERATURE</p> <ul style="list-style-type: none"> Centrifuging process will start, when preselected temperature is reached. How to enable run START DELAY – OF TEMPERATURE function is described in <i>Start delay – of temperature</i> chapter.
---	--

8.4 Cooling in „SHORT” mode



	<ul style="list-style-type: none"> Cooling feature is available in SHORT mode. How to enable run centrifugation in SHORT mode is described in <i>SHORT mode</i>.
---	--

8.5 Cooling notes

Centrifuge with cooling – MPW-260R is equipped with an efficient cooling system. It allows obtaining selected temperatures in the chamber even at maximum spin speed or fast obtaining desired temperatures (e.g., +4°C). Note that time and possibility of obtaining a set temperature is dependent on multiple factors, including: the power of the cooling system, the shape of the rotor, the rotor speed, ambient temperature, etc. The temperature on the display is appropriate for the place of the temperature sensor in the chamber, accuracy is $\pm 1^\circ\text{C}$. The temperature of the sample may be different.

9. Parameters of centrifugation

This chapter contains exemplary screens of MPW-260R centrifuge (screens for MPW-260 – without cooling – do not include temperature field).

Simplified display	
	<ul style="list-style-type: none"> Press and hold  by 1 second. Choose PARAM. with \blacktriangle \blacktriangledown Press SET.

Normal display

```

SPEED          0
2000
-----
TIME          00:02:00
00:02:00
-----
TEMP          +19
+5°C
PRG-- 11716
PARAMETERS MENU+
    
```

- Press **SET**.
- With **▲▼◀▶** keys select **PARAM.**
- Press **SET**.

- It is possible to switch between two different screens via **◀▶** keys in **PARAMETERS** field.

```

PARAMETERS          1/2
-----
ACCELERATION          3
DECELERATION          3
RADIUS                mm 70
DENSITY              g/cm³ 1.2
TEMP. OFFSET         °C 0
CHAMBER DEL.        min 1
    
```

```

PARAMETERS          2/2
-----
ACCELERATION          3
DECELERATION          3
[ ] AUTOM. LID OPENING
[ ] START DELAY
    
```

ACCELERATION	chosen acc. characteristic (0-the fastest, 9-the slowest)
DECELERATION	chosen dec. characteristic (0-the fastest, 9-the slowest)
RADIUS [mm]	current rotor radius [mm]
DENSITY (g/cm³)	sample density [g/cm ³]
TEMP. OFFSET (°C)	value of temperature correction
CHAMBER DEL. (min)	delay between set thermal chamber mode and start it
THERMAL CHAMBER	cooling of the chamber without centrifuging
AUTOM. LID OPENING	opening cover after centrifuging automatically
START DELAY	starting delayed (after pressing START)

9.1 Acceleration/deceleration – changing characteristics

```



PARAMETERS          1/2
-----
ACCELERATION          3
DECELERATION          3
RADIUS                mm 70
DENSITY              g/cm³ 1.2
TEMP. OFFSET         °C 0
CHAMBER DEL.        min 1
    
```

- With **▲▼** keys select **ACCELERATION** or **DECELERATION**.
- Press **SET**.
- With **▲▼** keys select demanded number of characteristics.
- Press **SET**.

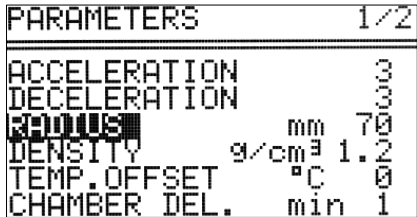
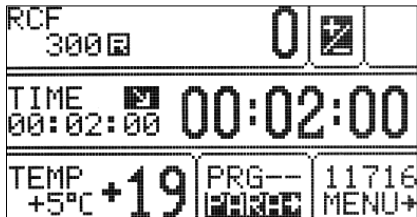

ACCELERATION –10 (0 ÷ 9), linear accelerating characteristics assigned to every rotor. 0-the fastest acceleration, 9-the slowest acceleration.

DECELERATION – 10 (0 ÷ 9), linear decelerating characteristics assigned to every rotor. 0-the fastest deceleration, 9-the slowest deceleration.

9.2 Radius

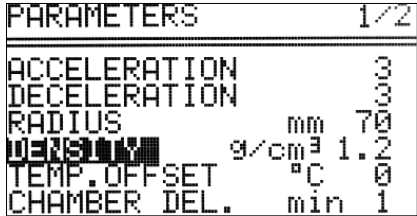

 <pre> PARAMETERS 1/2 ACCELERATION 3 DECELERATION 3 RADIUS mm 70 DENSITY g/cm³ 1.2 TEMP. OFFSET °C 0 CHAMBER DEL. min 1 </pre>	<p>RADIUS [mm] - control of the radius of the rotor within the range from R_{min} to R_{max}. Available values depend on chosen rotor. Radius corrections serve for more precise control RCF, exemplary when user need to know real RCF in half length of test tube.</p> <ul style="list-style-type: none"> To change the rotor radius, select RADIUS [mm] with ▲▼ keys. Press SET. Set demanded value by pressing ▲▼. Press SET.
 <pre> RCF 300 0 [R] TIME 00:02:00 00:02:00 TEMP +5°C +19 PRG-- 11716 +5°C +19 [R] MENU+ </pre>	<p>When radius correction is activated,  symbol is visible on the screen.</p> <p>Reducing of the rotor radius resulting change of displayed RCF value.</p>

9.3 Sample density

 <pre> PARAMETERS 1/2 ACCELERATION 3 DECELERATION 3 RADIUS mm 70 DENSITY g/cm³ 1.2 TEMP. OFFSET °C 0 CHAMBER DEL. min 1 </pre>	<p>DENSITY (g/cm³) – default density is set to 1,2 g/cm³</p> <p>To change the density (possible values 1,2÷9,9 g/cm³):</p> <ul style="list-style-type: none"> Via ▲▼ keys select DENSITY (g/cm³) Press SET. Set demanded value by pressing ▲▼. Press SET.
 <pre> SPEED 2000 0 [D] TIME 00:02:00 00:02:00 TEMP +5°C +19 PRG-- 11716 +5°C +19 [D] MENU+ </pre>	<p>When density is changed,  symbol is visible on the screen.</p> <p>Changing of DENSITY value is obligatory when density of sample placed into rotor is higher than 1.2 g/cm³. Change of DENSITY value led to decreasing maximum value of accessible speed.</p>

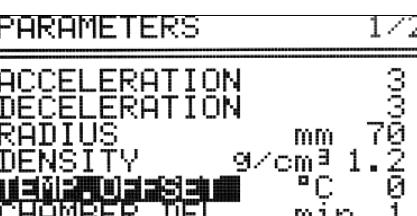

9.4 Temperature offset

	<p>MPW-260R only</p>
 <pre> PARAMETERS 1/2 ACCELERATION 3 DECELERATION 3 RADIUS mm 70 DENSITY g/cm³ 1.2 TEMP. OFFSET °C 0 CHAMBER DEL. min 1 </pre>	<p>Temperature offsets serve for more precise control of real sample temperature. It can be helpful in case high/low initial temperature samples or high-volume samples.</p> <ul style="list-style-type: none"> With ▲▼ keys select TEMP. OFFSET. Press SET. Use the ▲▼ keys to select the difference between the temperature that the cooling system will aim for

	<p>and set temperature. Confirm selection by pressing SET.</p> <p>Attention! The use of the offset cannot extend the temperature range achieved by the centrifuge.</p> <p>Function description</p> <p>At a set temperature of 20°C and the set offset value equal to -5°C, cooling system will actually strive to reach 15°C. With a setpoint temperature of 20°C and a set offset value of 5°C the system will actually try to reach 25°C.</p> <p>The temperature displayed on the main screen is corrected for offset value.</p> <p>Offset can be selected range from -20°C to 20°C.</p>
	<p>Activation of the function is signaled on the main screen with  or  depending on the offset value sign.</p>

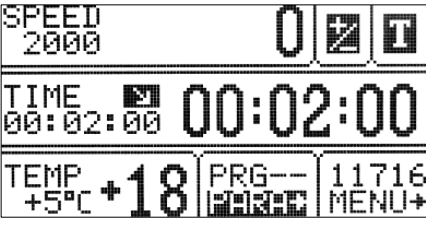

9.5 Thermal chamber

	<p>MPW-260R only</p>
---	----------------------

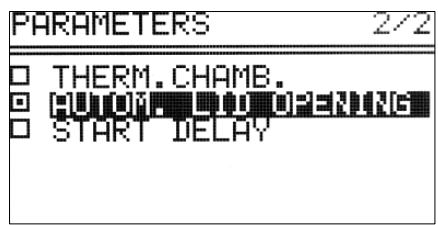
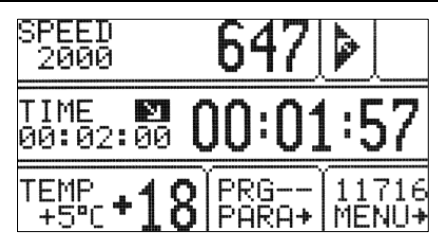

<p>Cooling without centrifuging.</p>	<p style="text-align: right;">THERMAL CHAMBER</p>
	<ul style="list-style-type: none"> ▪ With ▲▼◀▶ keys select THERMAL CHAMBER. ▪ Press SET (to turn on/off). ▪ With ▲▼ keys select temperature value. ▪ Set demanded value (0°C÷40°C) by pressing ▲▼. ▪ Confirm selection by pressing SET. <p>Attention, in the centrifuge without heating, do not set the thermal chamber to a value higher than currently indicated by the centrifuge.</p>
	<p>When THERMAL CHAMBER function is activated,  symbol is visible on the screen.</p> <p>Changing temperature from the main screen is not possible.</p> <p>Opening cover terminates THERMAL CHAMBER function (closing cover back turns it on).</p>
	<p>Thermal chamber is activated with delay.</p> <ul style="list-style-type: none"> ▪ Set time of delaying by select CHAMBER DEL. ▪ Press SET. ▪ With ▲▼ keys select demanded value (1-5 min). ▪ Press SET.

- The function is activated automatically after confirmation and with the lid closed. The function is interrupted when the lid is opened, and the function resumes when the lid is closed again. If the **THERMAL CHAMBER** function is enabled during the centrifugation cycle, at the end of this cycle, the **THERMAL CHAMBER** function is activated until the lid is opened.
- Unlike other parameters, the **THERMAL CHAMBER** function can be turned on only when the centrifuge is stopped.

9.6 Automatic lid opening



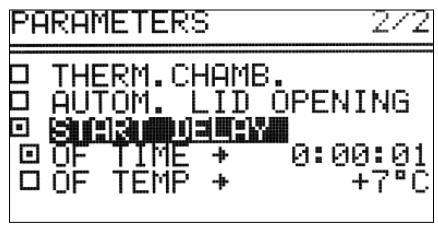
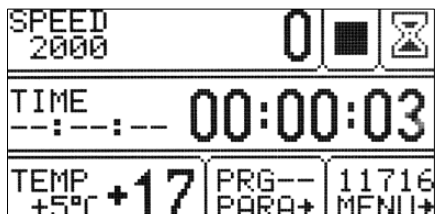

Automatic lid opening	AUTOMATIC LID OPENING
	<ul style="list-style-type: none"> ▪ When centrifuge process is finished, cover will be opened automatically for set option AUTOM. LID OPENING. ▪ When centrifuging is terminated by pressing STOP, opening cover is possible by pressing COVER.
	 symbol means that OPEN LID AFTER RUN is active.

9.7 Start delay - of time

	Start centrifuging since preselected delay is reached.	START DELAY / OF TIME
	<ul style="list-style-type: none"> ▪ With ▲▼ keys select START DELAY. Press SET. Start delay can be set from 0 : 0 0 : 0 1 to 9 : 5 9 : 5 9. ▪ With ▲▼ keys select OF TIME. Press SET and ▶ and then SET. ▪ With ▲▼ keys set demanded value. ▪ Confirm by pressing SET. ▪ Press BACK to escape edit mode. 	
	When START DELAY function is activated,  symbol is visible on the screen.	
<ul style="list-style-type: none"> ▪ START DELAY / OF TIME function can be stopped at any moment by pressing STOP. 		
<ul style="list-style-type: none"> ▪ START DELAY / OF TIME function cannot be run when START DELAY / OF TEMP. is activated. 		

9.8 Start delay – of temperature

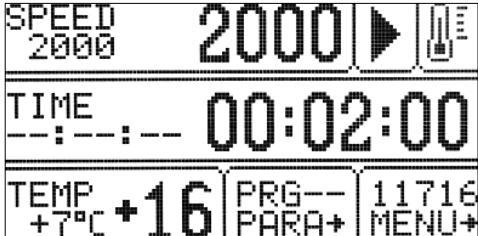
	MPW-260R only
---	---------------

	Start centrifuging time counting since preselected temperature is reached.	START DELAY / OF TEMP.
		<ul style="list-style-type: none"> ▪ With ▲▼◀▶ keys mark START DELAY. ▪ Press SET. ▪ With ▲▼◀▶ keys mark OF TEMP. ▪ Press SET. ▪ Press ▶, press SET. ▪ With ▲▼ keys set demanded value of temperature. ▪ Press SET. ▪ Exit edit mode by press BACK.
		When START DELAY – OF TEMPERATURE is turned on,  symbol is visible on the screen.
<ul style="list-style-type: none"> ▪ When the function is active, the speed can be reduced to the optimum values for the FAST COOL function, when the set speed is lower than the optimum value, the rotor rotates at the set by user speed. 		
<ul style="list-style-type: none"> ▪ The delay starts - from the temperature can be interrupted at any time by pressing the STOP key. 		
<ul style="list-style-type: none"> ▪ START DELAY / OF TEMP. function cannot be run when START DELAY / OF TIME is activated. 		

9.9 Printing report (USB)

When the centrifuging process is finished there is a possibility to obtain report. Report can be transferred to PC or printed.

PC (USB)

The elements needed to make connecting your computer via USB:

name	quantity (pcs.)	cat. No.
USB A-A cable	1	16655
MPW Editor 2 application	1	to downloaded from the website: www.mpw.pl

Operating System Requirements: **Microsoft Windows 10 (64bit)**.

The Manufacturer does not guarantee that the program will work correctly with other operating systems.

Preparation

- Download installation file from website at www.mpw.pl.
- Unzip the file and run **setup.exe**.
- Install **MPW Editor 2** application on the computer, press **Install**.

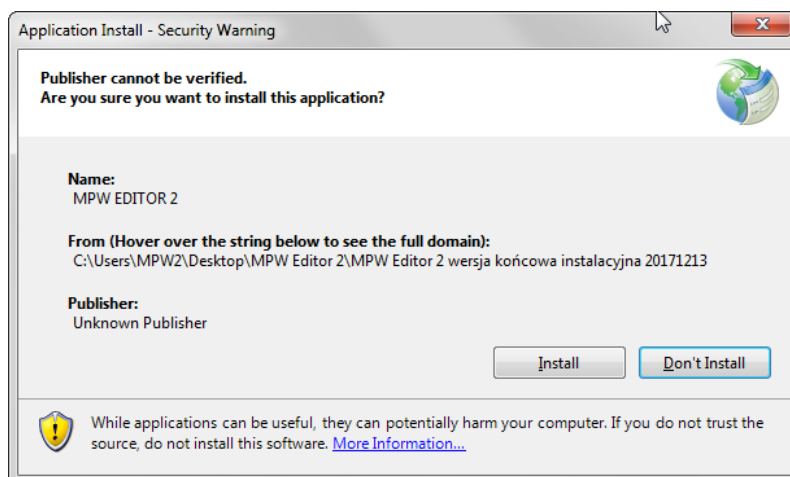

- If necessary, install **FTDI USB drivers** and **.NET Framework 4.0** library (download with manufacturer's website: www.mpw.pl).

Centrifuging and printing

- Run **MPW Editor 2** application.
- Choose **Język\English**

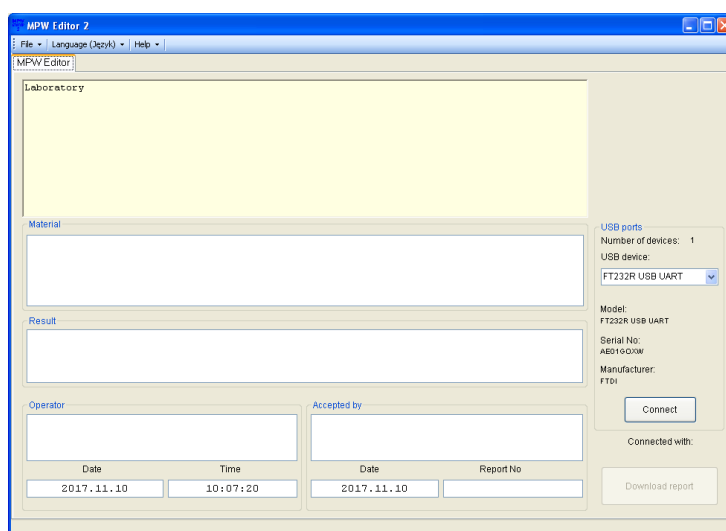

- Connect centrifuge to the PC in accordance with the „**Connection scheme**”
- Choose port assigned to the centrifuge (it will appear after connecting USB cable).

Attention:

If the interface has not been programmed: name, serial number and manufacturer's name, the device will be identified by Windows and MPW Editor 2 with the data programmed by FTDI (manufacturer USB integrated circuit) for example FT232R USB UART.

- Choose **File\Edit form**

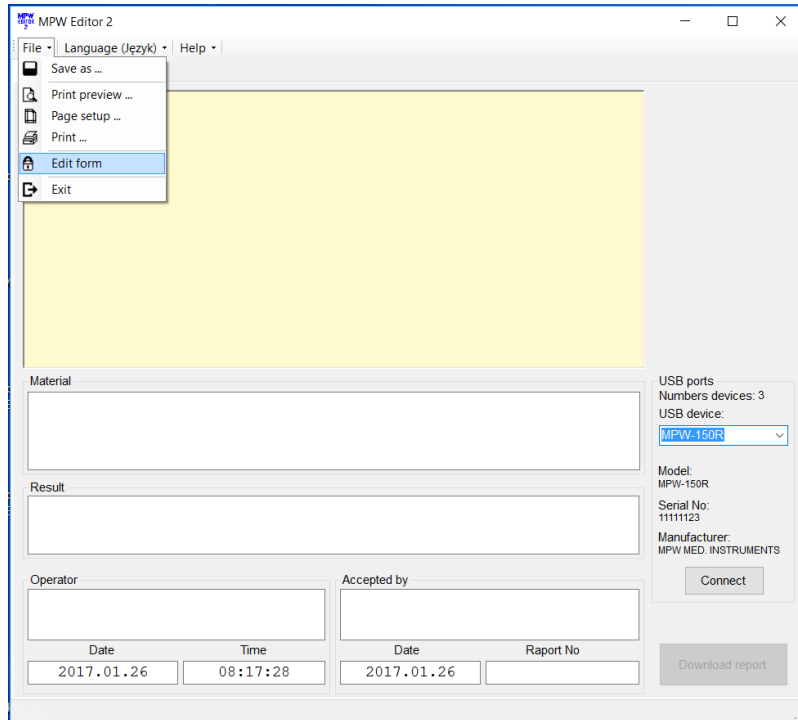

- In the „Tytuł (Title)” field, you can place any text, for example name of the laboratory, for later use in the report template.

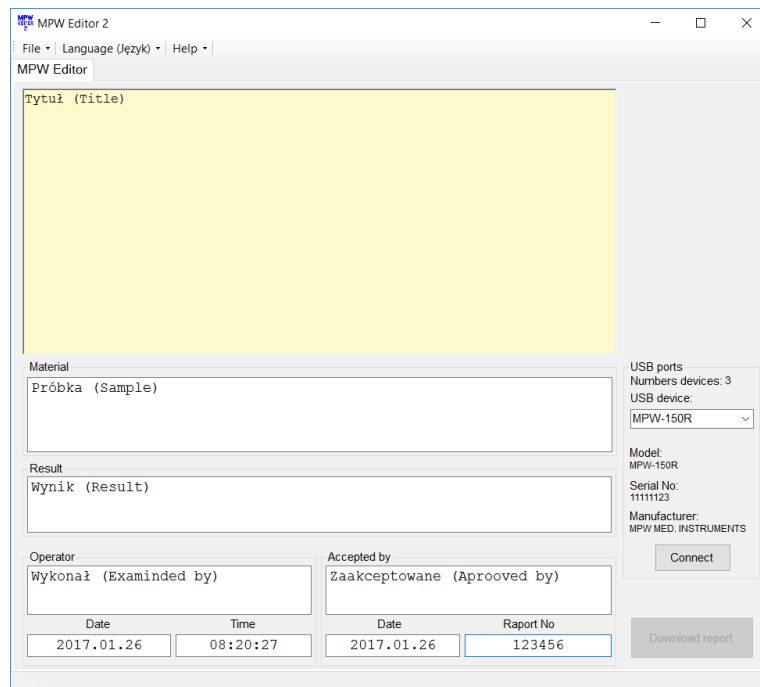

- Choose **File\Save form**.
- Ensure that USB device is selected from the list of devices.
- Press **Connect**. After successful communication, "PC" appears in the display.

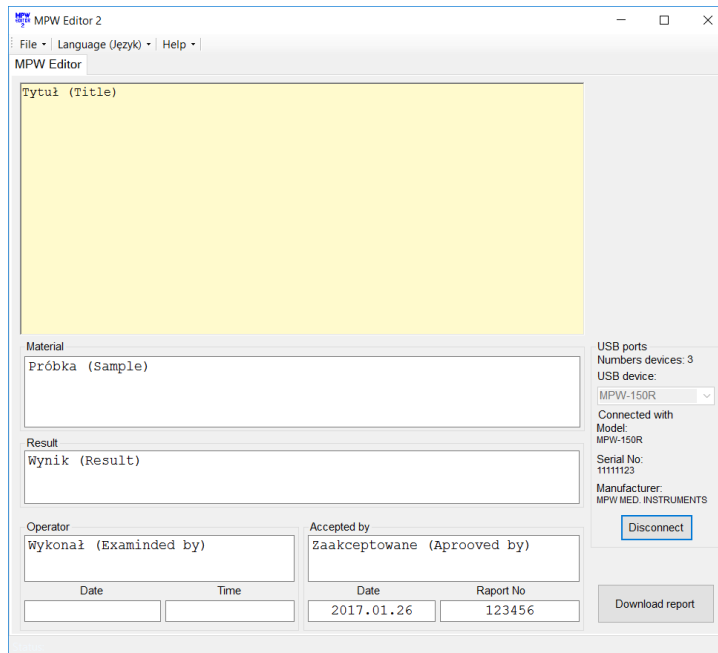



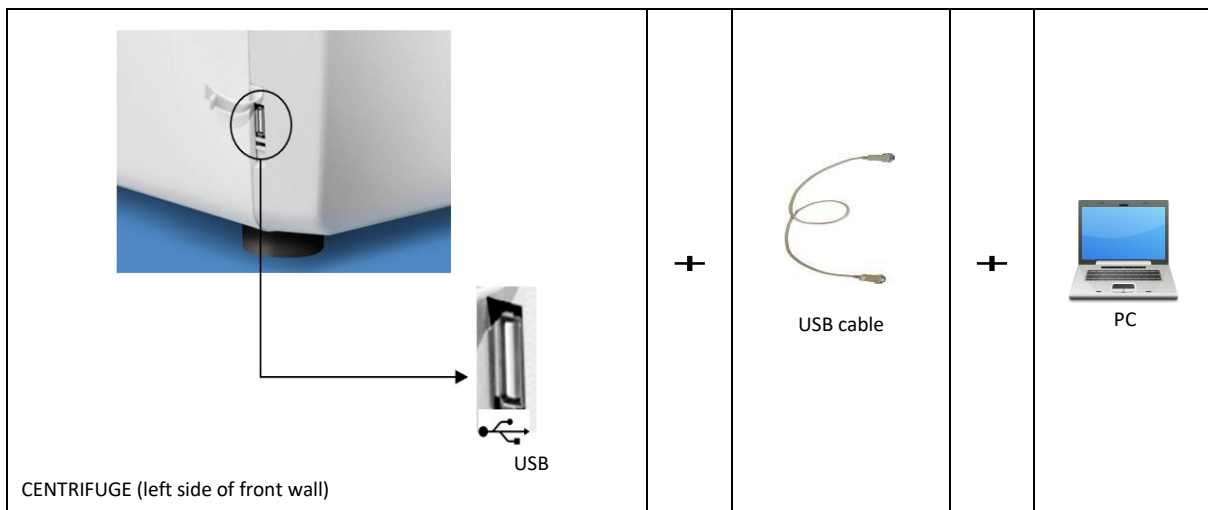

- Fill folds: „Material”, „Result”, „Operator”, „Accepted by”, „Report no” (optionally).
- When the centrifuging process is finished, press **Download the report**.
- When centrifuging process is completed, report will appear.
- Save report (**File/Save as**) or print it (**File/Print**).
- In order to get another report, press New test and press Download the report.
- After finishing the work, press **Disconnect** button (the "PC" disappears from the display of the centrifuge) and then closes MPW Editor 2.

Connection diagram

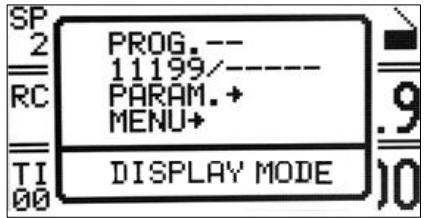

10. Menu

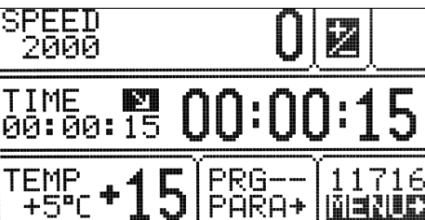
This chapter contains exemplary screens of MPW-260R centrifuge (screens for MPW-260 – without cooling – do not include temperature field).

Simplified display	
	<ul style="list-style-type: none"> Press and hold  by 1 second. Choose MENU with ▲▼ Press SET. <p>Execute points described follow (below Normal display mode description)</p>
Normal display	
	<ul style="list-style-type: none"> Press SET. With ▲▼◀▶ keys select MENU. Press SET.
	<ul style="list-style-type: none"> To navigate in MENU use ▲▼◀▶ keys. To enter menu press SET.
CONFIGURATION	centrifuge configuration
PASSWORD	password protection
LAST 10-CYCLES	10 last centrifugation cycles history
CYCLES	total working time of centrifuge, total number of working cycles
ROTOR RUNTIME	counting time of work and cycles amount for each rotor
CONTACT US	manufacturer's details
DIAGNOSTICS	error codes (service field)
FACTORY SETTINGS	restore factory settings

10.1 Screen saver

Setting time of screen saver	MENU/ CONFIGURATION / SCREEN
	<ul style="list-style-type: none"> With ▲▼◀▶ keys select SCREENSAVER. Press SET and then ▼ and SET. With ▲▼ keys select demanded value from 1 to 60 minutes. Mark selection by pressing SET. Leave the menu by pressing BACK.

10.2 Visual alarm

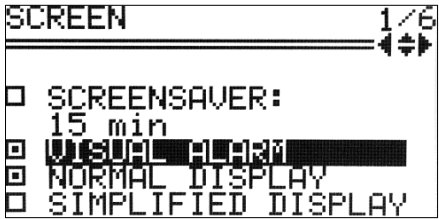
Visual alarm	MENU/CONFIGURATION/ SCREEN
 <p>SCREEN 1/6</p> <p>□ SCREENSAVER: 15 min</p> <p>▣ VISUAL ALARM</p> <p>▣ NORMAL DISPLAY</p> <p>□ SIMPLIFIED DISPLAY</p>	<ul style="list-style-type: none"> Via ▲▼ keys choose VISUAL ALARM Mark it by pressing SET. <p>VISUAL ALARM cause blinking screen after ending of centrifuging or after message occurring.</p>

10.3 Types of main screen

To ensure optimal adaptation to the user's preferences, work is possible in two basic screen modes.

NORMAL DISPLAY - contains an expanded number of parameters visible on the display.

SIMPLIFIED DISPLAY - contains only the most important parameters visible on the display.

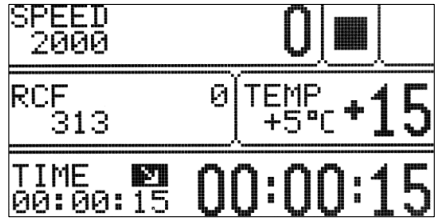

For each of the above modes, you can choose priority RPM display or RCF.

By default, the **SIMPLIFIED DISPLAY** is set

Types of main screen	
NORMAL DISPLAY	SIMPLIFIED DISPLAY
 <p>SPEED 2000 0</p> <p>TIME 00:00:15 00:00:15</p> <p>TEMP +5°C +15 PRG-- 11716 PARA+ MENU+</p>	 <p>SPEED 2000 0</p> <p>RCF 313 0 TEMP +5°C +15</p> <p>TIME 00:00:15 00:00:15</p>
Switch between the SPEED (RPM) and RCF display priority modes	
<ul style="list-style-type: none"> In the NORMAL DISPLAY mode, selecting the SPEED or RCF display mode is obtained by pressing and holding BACK for 1 sec. then use the ▲▼ buttons to select the desired mode (SPEED or RCF) and press SET. 	<ul style="list-style-type: none"> In the SIMPLIFIED DISPLAY mode, the selection of the SPEED or RCF display mode is obtained by pressing and holding the BACK key for 1 second. then use ▲▼ keys to select DISPLAY MODE, press SET, and then use ▲▼ keys to select the desired mode (SPEED or RCF) and press SET.

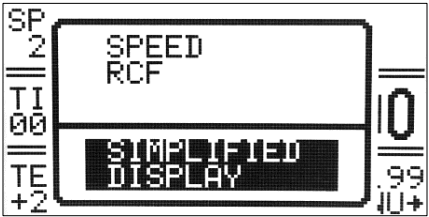

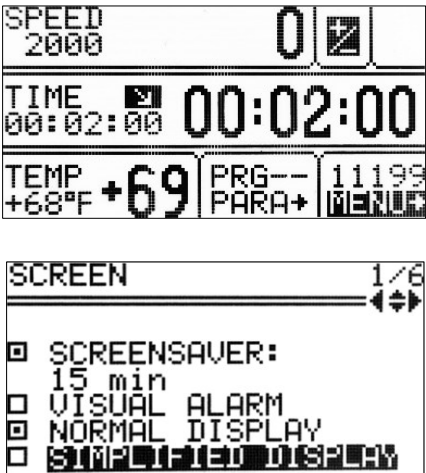
10.3.1 Switching the normal display to simplified display

Method I	
 <p>SP 2 SPEED RCF</p> <p>TI 00</p> <p>TE +2</p> <p>SIMPLIFIED DISPLAY</p> <p>10 .99 10+</p>	<ul style="list-style-type: none"> Press the BACK button for 1 sec. to return to the basic display (a short menu is displayed on the screen), then: Via ▲▼ keys select SIMPLIFIED DISPLAY. Press SET.

<i>Method II</i>	
 <p>The screenshot shows a control panel with the following information: SPEED 2000, TIME 00:02:00, TEMP +68°F +69, PRG-- 11199, PARA+ MENU. Below this is a SCREEN menu with options: SCREENSAVER: 15 min, VISUAL ALARM, NORMAL DISPLAY, and SIMPLIFIED DISPLAY.</p>	<ul style="list-style-type: none"> ▪ Press SET –  appears. ▪ Via ▲▼◀▶ keys select MENU. ▪ Press SET. ▪ Via ▲▼ keys select CONFIGURATION tab. ▪ Press SET. ▪ Via ◀▶ keys select SCREEN tab. ▪ Via ▲▼ keys select SIMPLIFIED DISPLAY. ▪ Press SET. ▪ Leave menu via BACK key.

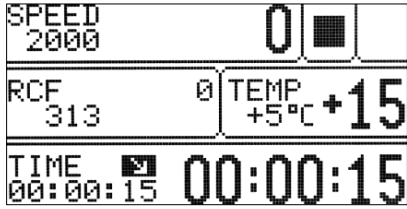
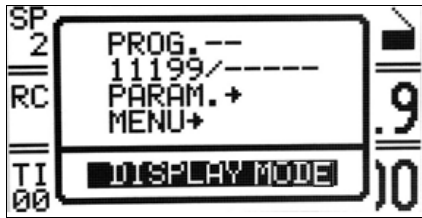
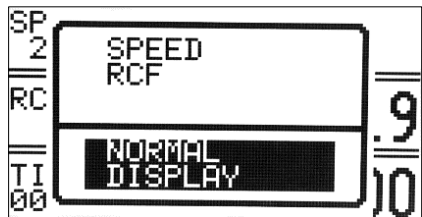
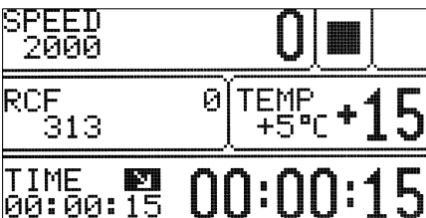
10.3.2 Switching the simplified screen to normal display

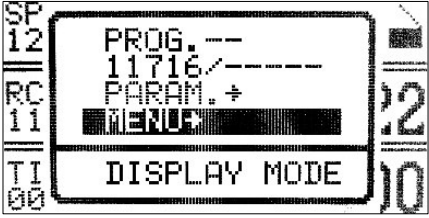
<i>Method I</i>	
 <p>The screenshot shows: SPEED 2000, RCF 313, TEMP +5°C +15, TIME 00:00:15.</p>	<ul style="list-style-type: none"> ▪ Press the BACK button for 1 sec.
 <p>The screenshot shows a menu with options: PROG.--, 11199/----, PARAM.+ MENU+, and DISPLAY MODE (highlighted).</p>	<ul style="list-style-type: none"> ▪ Via ▲▼ keys select DISPLAY MODE (highlighted). ▪ Press SET.
 <p>The screenshot shows a menu with options: SPEED RCF and NORMAL DISPLAY (highlighted).</p>	<ul style="list-style-type: none"> ▪ Then choose NORMAL DISPLAY via ▲▼ keys. ▪ Press SET.
<i>Method II</i>	
 <p>The screenshot shows: SPEED 2000, RCF 313, TEMP +5°C +15, TIME 00:00:15.</p>	<ul style="list-style-type: none"> ▪ Press the BACK button for 1 sec.

	<ul style="list-style-type: none"> Via ▲▼ keys select MENU (highlighted). Press SET.
	<ul style="list-style-type: none"> Via ▲▼ keys select CONFIGURATION tab. Press SET. Via ◀▶ keys select SCREEN tab. Via ▲▼ keys select NORMAL DISPLAY. Press SET. Leave menu via BACK key.

10.4 Rotating runtime

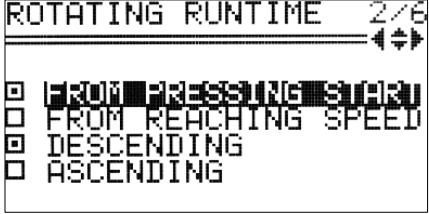
Way of time counting	MENU/CONFIGURATION/ ROTATING RUNTIME
	<ul style="list-style-type: none"> Via ▲▼ choose demanded option. Mark it by pressing SET.
Counting from:	
From pressing start →	COUNTING SINCE ROTOR IS IDENTIFIED
From reaching speed →	COUNTING FROM ASSIGNED SPEED
Presenting mode:	
Descending →	COUNTING DOWN
Ascending →	COUNTING UP

10.5 Buzzer

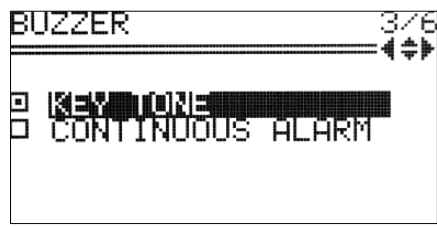
<p>Switching ON/OFF short audible signals accompanying every pressing of any key. Switching ON/OFF signals after centrifuging.</p>	MENU/ CONFIGURATION /BUZZER
	<ul style="list-style-type: none"> With ▲▼ keys select demanded option. Mark selection by pressing SET. <p>A continuous alarm means the emission of short beeps after the end of the spin, until the message about the end of the work cycle is deleted.</p>
<ul style="list-style-type: none"> Warning signals are always switched on. 	

10.6 Date/time

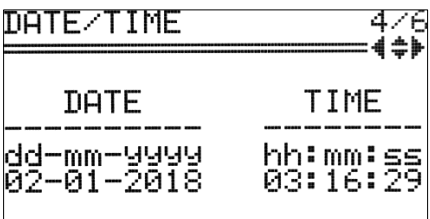
Setting up time and date	MENU/ CONFIGURATION /DATE/TIME
	<ul style="list-style-type: none"> Press SET. Via ◀▶ keys choose demanded value. Via ▲▼ keys change chosen value. Confirm by pressing SET. Repeat above steps for other values. Press BACK.
<ul style="list-style-type: none"> Set date and time are still active even after restart of centrifuge. 	

10.7 Language

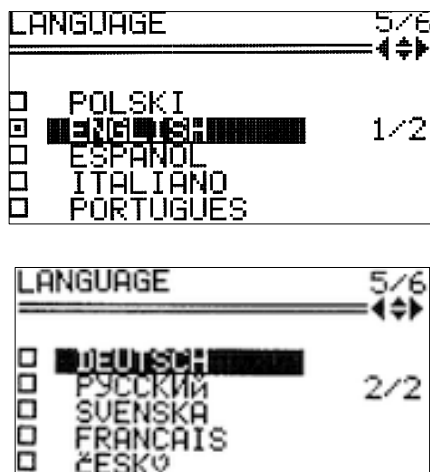
Changing menu language	MENU / CONFIGURATION / LANGUAGE
	<ul style="list-style-type: none"> Via ▲▼ keys choose demanded menu language Mark it by pressing SET.

10.8 Other

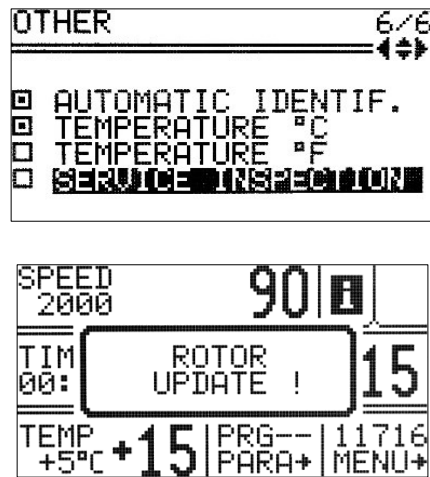

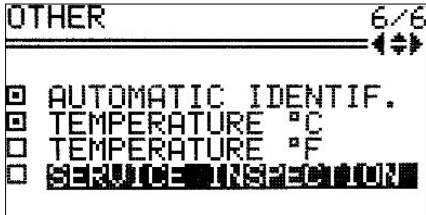
Rotor automatic identification	MENU / CONFIGURATION / OTHER
	<p>Thanks to the automatic rotor identification, the centrifuge automatically identifies the rotor in the chamber. Rotor identification is indicated by the message.</p> <p>When the function is deactivated, it is necessary to manually select the desired rotor as described in “Rotor and bucket choosing”.</p> <p>The AUTOMATIC IDENTIF. is turned on by default.</p> <p>To enable/unable the function:</p> <ul style="list-style-type: none"> Via ▲▼ keys choose <ul style="list-style-type: none"> <input type="checkbox"/> AUTOMATIC IDENTIF. Press SET (<input type="checkbox"/> change to <input checked="" type="checkbox"/> or conversely). <p>Autoidentification is not active for work in the loaded program mode.</p>

Choice of temperature unit (only MPW-260R)	MENU / CONFIGURATION / OTHER
	<p>The TEMPERATURE in °C is turned on by default.</p> <p>To change the temperature unit:</p> <ul style="list-style-type: none"> Via ▲▼ keys select unit Confirm by pressing SET.

TEMPERATURE IN °C

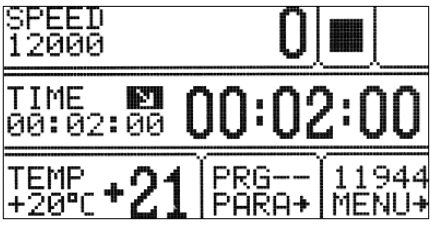
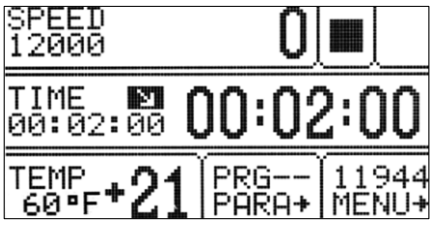

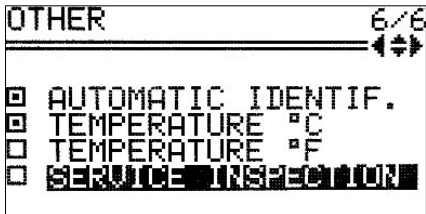







TEMPERATURE IN °F

	
---	--

Service inspection	MENU / CONFIGURATION / OTHER
  	<p>There is a possibility to turn on a message reminding user to perform the inspection, with the option to define the date of the inspection when the message will be displayed.</p> <p>To enable/disable the function:</p> <ul style="list-style-type: none"> Via ▲▼ keys choose <input type="checkbox"/> SERVICE INSPECTION. Press SET (<input type="checkbox"/> change to <input checked="" type="checkbox"/> or conversely). <p>A new field will appear with the date of the inspection (on that day message will be displayed).</p> <p>To edit the date:</p> <ul style="list-style-type: none"> Via ▲▼ keys select date field. Press SET. Via ▲▼◀▶ keys choose value. Confirm by pressing SET.

10.9 Password

Setting up password	MENU / PASSWORD
<p>To prevent from an unauthorized use, a PASSWORD can be set.</p> <p>Note: No PASSWORD is set by default.</p> <p>The PASSWORD can be set as follows when the rotor is at a standstill.</p>	

 <p>PASSWORD</p> <p>PASSWORD:</p> <p>****</p>	<ul style="list-style-type: none"> Press SET. Icon  starts blinking. With ◀▶ keys set the valid place of the PASSWORD. With ▲▼ keys set correct value. Repeat above steps for all places. Press SET.
 <p>PASSWORD</p> <p>PASSWORD:</p> <p>343</p>	<ul style="list-style-type: none"> As a confirmation repeat instructions described above.
<p>PASSWORD</p> <p>CONFIRM:</p> <p>3420</p>	
<p>When the PASSWORD is set, the Key sign is displayed in the CODE zone. It is also displayed in the main menu (lower right corner of the screen).</p>	
 <p>LOCK: </p> <ul style="list-style-type: none"> <input type="checkbox"/> SAVE PROGRAM <input type="checkbox"/> DELETE PROGRAM <input type="checkbox"/> CHANGE PARAMETERS <input type="checkbox"/> LOAD PROGRAM <input type="checkbox"/> START KEY 	 <p>SPEED 12000 0 </p> <p>TIME 00:02:00 00:02:00</p> <p>TEMP +20°C +21 PRG-- 11944 PARA+ MENU+</p>
<ul style="list-style-type: none"> From then on, access to the MENU is possible after entering the password. In case of incorrect password, it will show message: ACCESS DENIED! 	
<ul style="list-style-type: none"> To delete the PASSWORD, "0000" must be set (after previously entering current password). If the PASSWORD is forgotten, the emergency code "7654" should be used to clear password and remove all locks. 	
<p>Setting up locks</p>	
 <p>LOCK: </p> <ul style="list-style-type: none"> <input checked="" type="checkbox"/> SAVE PROGRAM <input type="checkbox"/> DELETE PROGRAM <input type="checkbox"/> CHANGE PARAMETERS <input type="checkbox"/> LOAD PROGRAM <input type="checkbox"/> START KEY 	<ul style="list-style-type: none"> With ▲▼ keys choose a lock. Mark a lock by pressing SET. Repeat above steps for desired locks. Leave menu with BACK key.
 <p>LOCK: </p> <ul style="list-style-type: none"> <input type="checkbox"/> SAVE PROGRAM <input checked="" type="checkbox"/> DELETE PROGRAM <input type="checkbox"/> CHANGE PARAMETERS <input type="checkbox"/> LOAD PROGRAM <input type="checkbox"/> START KEY 	<ul style="list-style-type: none"> In the LOCK menu, press ◀ and then SET.

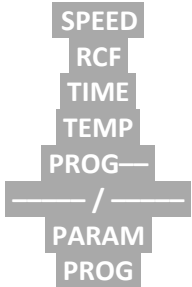
	disabled*	description
SAVE PROGRAM	SAVE button	no programs can be saved
DELETE PROGRAM	DELETE button	no programs can be deleted saving programs on position where one was already stored is disabled
CHANGE PARAMETERS	fields: 	parameters cannot be modified
LOAD PROGRAM	LOAD button	no programs can be called up
START KEY	START key	centrifugation cannot be started

* Executing disabled procedures is only possible after entering the correct password.

10.10 Last 10 cycles

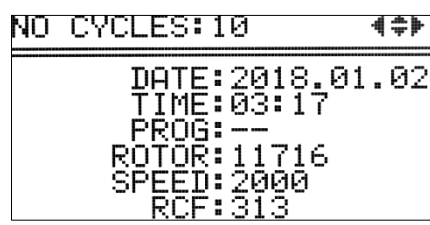
Information concerning parameters of last 10 centrifuging cycles.	MENU / LAST 10 CYCLES
	<ul style="list-style-type: none"> Number of cycles can be changed by ◀▶ keys. The list can be scrolled using ▲▼ keys. To exit press SET/BACK key

10.11 Work time

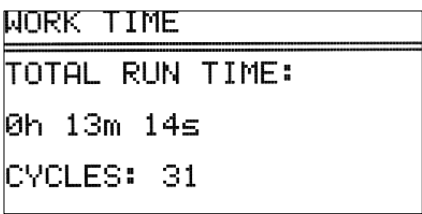
Total working time of centrifuge, and quantity of working cycles.	MENU / WORK TIME
	<p>In the WORK TIME menu, the following statistics are displayed:</p> <ul style="list-style-type: none"> total working (centrifugation) time working cycles counter

10.12 Rotor runtime

Information about the time of centrifuging and of the quantity of the working cycles of each rotor. The table also contains icons warning of the duty of execution of validation.	MENU / ROTOR RUNTIME
---	-----------------------------

<pre> ┌ ROTOR CYCLES NOM.C. ├───┬───┬─── ✓ 11199 0 15000 ✓ 11461 0 15000 ✓ 11716 15 15000 ✓ 11760 0 15000 ✓ 11942 11 15000 ✓ 11943 0 15000 </pre>	<p>CYCLES – the number of centrifuging the rotor has performed, NOM.C. – permissible number of centrifuging for the rotor.</p> <ul style="list-style-type: none"> ▪ The list can be scrolled using ▲▼ keys. ▪ To exit press BACK key. <p>Symbols:</p> <ul style="list-style-type: none"> ✓ – more than 100 cycles left ! – less than 100 cycles left ■ – worn rotor <p>It is not allowed to use rotors marked as worn.</p>
---	---

10.13 Contact us

<p>Information about the type of the centrifuge, firmware version, and contact details.</p>	<p>MENU / CONTACT US</p>
<pre> CONTACT US ├───┬───┬─── MPW MED. INSTRUMENTS 04-347 WARSAW 46 BOREMLOWSKA Street ----- WWW.MPW.PL MPW@MPW.PL </pre>	<ul style="list-style-type: none"> ▪ The list can be scrolled using ▲▼ keys. ▪ To exit press BACK key.

10.14 Diagnostics

<p>Information about errors arisen in working of the centrifuge (for service).</p>	<p>MENU / DIAGNOSTICS</p>
<pre> No DATA TIME ERROR ├───┬───┬───┬─── 1 14.03.05 18:36 183 </pre>	<p>Intended for service purposes!</p>

10.15 Factory settings

<p>Restoring factory settings.</p>	<p>MENU/ FACTORY SETTINGS</p>
<p>All settings of user programs will be deleted.</p>	
<pre> FACTORY SETTINGS: ├───┬───┬─── WARNING! ALL PROGRAMS, SETTINGS AND CONFIGURATION WILL BE LOST. CONTINUE? YES NO </pre>	<ul style="list-style-type: none"> ▪ Via ◀▶ keys choose YES or NO. ▪ Confirm by pressing SET.

11. Maintenance

11.1 *Cleaning of the centrifuge*

	<ul style="list-style-type: none">▪ Pull the mains plug before cleaning.▪ Before any cleaning or decontamination process other than that is recommended by the manufacturer, the user has to ask the manufacturer if the planned process does not damage the device▪ For cleaning, water with soap or other water-soluble mild detergent shall be used.▪ One should avoid corrosive and aggressive substances. It is prohibited to use alkaline solutions, inflammable solvents or agents containing abrasive particles.▪ Do not lubricate the centrifuge motor shaft.▪ The unused centrifuge should have cover opened. Once a week▪ Using wiping cloth, remove condensate or residues of the products from the rotor chamber. Once a month▪ Check the rotor clamping thread. In case of damage, replaced it.▪ Check the centrifuging chamber whether it is damaged. In case of damage, it cannot be longer put into operation. Notify authorized service workshop.
---	--

11.2 *Maintenance of centrifuge elements*

	<p>The rotor pins shall be always lubricated with petroleum jelly. In this way, the uniform deflection of the buckets and quiet centrifuge operation is ensured.</p>
---	--

Cleaning of the accessories

	<ul style="list-style-type: none">▪ In order to ensure safe operation, one shall carry out in regular way periodical maintenance of the accessories.▪ Rotors, buckets and round carriers have to withstand high stresses originating from the centrifugal force. Chemical reactions as well as corrosion (combination of variable pressure and chemical reactions) can cause destruction of metals. Hard to observe surface cracks increase gradually and weaken material without visible symptoms.▪ In case of observation of surface damage, crevice or other change, as well as the corrosion, the given part (rotor, bucket, etc.) shall be immediately replaced.▪ Clamping rotor, containers and reducer inserts must be cleaned regularly to prevent corrosion.▪ Cleaning of the accessories shall be carried out outside of the centrifuge once every week or still better after each use. For cleaning them one should use neutral agent of pH value 6÷8. It is forbidden to use alkaline agent of pH > 8. Then, those parts shall be dried using soft fabric or in the chamber drier at ca. 50°C.▪ Angle rotor should be placed on a fabric with holes facing down, for effective drying.▪ Do not use bleach on plastic parts of the rotor.
---	--

	<ul style="list-style-type: none"> ▪ In this way, the useful service life of the device is substantially increased and susceptibility to corrosion is diminished. Accurate maintenance increases the service life as well and protects against premature rotor failures. ▪ Do not use bleach on plastic parts of the rotor. ▪ According to laboratory standards, minimize the immersion time in each solution. ▪ Especially prone to the corrosion are parts made of aluminum. ▪ Corrosion and damages resulting from insufficient maintenance could not be subject of claims lodged against the manufacturer. ▪ The unused rotor should have the lid removed.
--	--

HS accessories maintenance.

	<ul style="list-style-type: none"> ▪ Check the general condition of seals. ▪ Make sure that rubber O-rings are lightly coated with silicone grease. Use high vacuum grease, e.g., type „C” by LUBRINA. ▪ In order to maintain hermetic sealing, it is recommended to replace the sealing rings after each autoclaving. ▪ Store hermetically sealed rotors and buckets with the lids removed.
---	--

11.3 Sterilization

Plastics - legend to abbreviations

PS	polystyrene	ECTFE	ethylene/chlorotrifluoroethylene
SAN	styrene-acrylonitrile	ETFE	ethylene/tetrafluoroethylene
PMMA	polymethyl methacrylate	PTFE	polytetrafluoroethylene
PC	polycarbonate	FEP	tetrafluoroethylene/perfluoro propylene
PVC	polyvinyl chloride	PFA	tetrafluoroethylene/perfluoroalkylvinylether
POM	acetal polyoxymethylene	FKM	fluorocarbon rubber
PE-LD	low density polyethylene	EPDM	ethylene propylene diene
PE-HD	high density polyethylene	NR	natural rubber
PP	polypropylene	SI	silicon rubber
PMP	polymethyl pentene		

One can use all standard disinfectants. Centrifuges and devices are made of different materials, one should consider their variety.

	radiation β radiation γ 25 kGy	C ₂ H ₄ O (ethylene oxide)	formalin, ethanol
PS	●	○	●
SAN	○	●	●
PMMA	●	○	●
PC	●	●	●
PVC	○	●	●
POM	●	●	●
PE-LD	●	●	●
PE-HD	●	●	●
PP	●	●	●
PMP	●	●	●
ECTFE, ETFE	○	●	●
PTFE	○	●	●
FEP, PFA	○	●	●

FKM	○	●	●
EPDM	○	●	●
NR	○	●	●
SI	○	●	●

- may be used
- cannot be used

In the centrifuge, disinfectants and cleaning agents generally used in medical care should be used (e.g., *Aerodesina-2000*, *Lysoformin 3000*, *Melseptol*, *Melsept SF*, *Sanepidex*, *Cutasept F*).

11.3.1 Autoclaving

- Rotors, buckets and round carriers can be sterilized in autoclave with temperature 121°C during 20 min (215 kPa), unless otherwise specified in the OPTIONAL ACCESSORY.
- During sterilization (autoclaved) by means of steam one should consider temperature resistance of individual materials.
- Deformation of the accessories (carriers or lids made of plastic) may occur during autoclaving.
- Do not autoclave disposable materials (e.g., tubes, cyto-container).
- The life of the accessory depends on the frequency of autoclaving and use.
- Autoclaving reduces lifespan of plastic components. They should be replaced if any signs of damage are visible, including a change in color or shape or when leakage etc.
- Pressure in closed containers can cause plastic deformation or explosion.
- Prior to autoclaving the rotors and accessories, thoroughly wash and rinse with distilled water.
- Never exceed the permissible autoclaving temperature and time.
- If you want to keep the hermetic seals, replace the sealing rings after each autoclave.

Chemical resistance of plastics

	autoclaving 121 °C, 20 min		autoclaving 121 °C, 20 min
PS	○	PMP	●
SAN	○	ECTFE, ETFE	●
PMMA	○	PTFE	●
PC	●	FEP, PFA	●
PVC	○ ¹⁾	FKM	●
POM	●	EPDM	●
PE-LD	○	NR	○
PE-HD	○	SI	●
PP	●		

- may be used
- cannot be used

1) Except PVC hoses which are resistant to the steam sterilization in the temperature 121°C.

11.4 Chemical resistance



Chemical resistance of plastics

	aldehydes	cyclic alcohols	esters	ether	ketones	strong or concentrated acids	weak or diluted acids	oxidizing substances	cyclic hydrocarbons	aromatics	haloid hydrocarbons	alkalis
PS	○	●	○	○	○	○/●	○/●	○	○	○	○	●
SAN	○	●	○	○	○	○	○/●	○	○	○	○	●
PMMA	○/●	●	○	○	○	○	○/●	○	○/●	○	○	○
PC	○/●	●	○	○	○	○	○/●	○	○/●	○	○	○
PVC	○	●	○	○	○	●	●	○	●	○	○	●
POM	○/●	●	○	●	●	○	○	○	●	●	●	●
PE-LD		●	●	●	○/●	●	●	○	●	●	●	●
PE-HD	●	●	○/●	○/●	○/●	●	●	○	●	○/●	○/●	●
PP	●	●	○/●	○/●	○/●	●	●	○	●	○/●	○/●	●
PMP	○/●	●	○/●		○/●	●	●	○	○/●	○	○	●
ECTFE	●	●	●	●	○	●	●	●	●	●	●	●
ETFE	●	●	●	●	○	●	●	●	●	●	●	●
PTFE	●	●	●	●	●	●	●	●	●	●	●	●
FEP	●	●	●	●	●	●	●	●	●	●	●	●
PFA	●	●	●	●	●	●	●	●	●	●	●	●
FKM	●	○	○	○	○	○	●	○/●	○/●	○/●	○/●	○/●
EPDM	●	●	○/●	○	○/●	●	●	○/●	○	○	○	●
NR	○/●	●	○/●	○	○	○	○/●	○	○	○	○	●
SI	○/●	●	○/●	○	○	○	○/●	○	○	○	○	○/●

●	very good	Permanent action of the substance does not cause damage through 30 days. The material is able to be resistant through years
○/●	good to limited	Continuous action of the substance causes insignificant and partly reversible damage through the period of 7-30 days (e.g., puffing up, softening, reduced mechanical durability, discoloring).
○	limited	The material should not have the continuous contact with the substance. The immediate occurrence of damage is possible (e.g., the loss of mechanical durability, deformation, discoloring, bursting, dissolving).







Rubber inserts shall be exactly cleaned or possibly replaced. Centrifuges and accessories are made of different materials.

Do not use bleach on plastic parts of the rotor.

	DANGER! MPW accessories are not biotight. For centrifuging infectious materials, it is necessary to use hermetically closed tubes meeting demands of biotightness, in order to prevent germs migration into the centrifuge and beyond it.
	User is responsible for proper disinfections of the centrifuge if some dangerous material was spilled inside or outside of the centrifuge. During the above mentioned works one must wear safety gloves.

12. Troubleshooting

Majority of faults could be removed by switching the centrifuge OFF and then ON. After switching the centrifuge ON, there shall be displayed parameters of the recently implemented program and sound signals comprising four successive tones shall be generated. In case of short-duration power failure the centrifuge terminates the cycle and displays PROGRAM ERROR code.

problem	question	remedy
Centrifuge does not start	<i>Is supply cable plugged into mains?</i>	<i>Plugs supply cable correctly.</i>
	<i>Is master switch ON?</i>	<i>Switch ON power supply.</i>
Motor error is displayed		Call service.
Centrifuge does not start (indications are proof for cycle in progress and motor does not start)	<i>Is  symbol displayed?</i>	Wait till rotor stops and the  symbol goes off.
	<i>Is  symbol displayed?</i>	Close cover.  symbol must switch off.
	<i>Is  symbol blinking?</i>	Centrifugation cycle in progress, press STOP key or wait till cycle ends.
Centrifuge does not accelerate (unbalance error)	<i>Unequal rotor load.</i>	Centrifuge load shall be balanced.
	<i>Inclined centrifuge.</i>	Centrifuge shall be levelled.
	<i>Faulty drive (mechanical damage).</i>	Call service.
	<i>Was centrifuge displaced during operation?</i>	Switch ON the centrifuge again after opening and closing the cover.
(motor error)	<i>After stopping error rotor message is displayed</i>	Check if rotor number in started program is consistent with the number of the rotor installed in the centrifuge. Check rotor status (if there are coding magnets inserted)
	<i>Centrifuge does not recognize the rotor and does not stop.</i>	Switch the centrifuge OFF, then ON and check correctness of loaded program
It is not possible to open the cover	<i> symbol on the display is blinking, after pressing COVER key single tone is audible</i>	Rotor is still rotating. Wait for stopping of the rotor and displaying of the  symbol.
	<i>The sensor is connected correctly, and the error is still applying.</i>	Call service.
Mains failure during run	<i>The message will be displayed on the display about the decay of tension.</i>	Wait for stopping of the rotor, clear the error by pressing the SET key.
Temperature sensor error	<i>The overheating message will be displayed.</i>	Switch the centrifuge OFF, then ON.
		Call service.
Error of the exceeding the temperature (50°C) in the chamber	<i>The overheating message will be displayed.</i>	Open the cover. Wait for the centrifuge to cool down.

12.1 Messages

Screen messages that may occur during operation.	
MESSAGE	EXPLANATION
"SPEED OF ROTOR" "IDENTIFICATION <> 90 RPM"	Please try start centrifuging again, if error still occur, contact manufacturer's authorized service.
"IMBALANCE FAST STOP !" "PLEASE REMOVE CAUSE" "THEN RESTART"	Rotor is not balanced correctly, please balance rotor.
"NO ROTOR OR IDENTIFICATION" "SENSOR DAMAGED !"	Make sure, is rotor mounted in the centrifuge chamber. If it is right contact manufacturer's authorized service.
"INCORRECT ROTOR NUMBER !"	Change rotor number in centrifuge settings or use autoidentification.
"WRONG DIRECTION OF ROTATION" "OR UNKNOWN ROTOR !"	Make sure if correct rotor for centrifuge is mounted. List of accessories is described in chapter 15.

"PLEASE CLOSE THE LID" "HAND !"	Necessity of manually closing the lid.
"ROTOR STOPPING !" "Please wait..."	Initializing after mains failure with rotating rotor, wait until rotor stop.

Emergency messages	
In case of emergency messages (centrifuge is not working properly) contact the manufacturer's authorized service center.	
MESSAGE	
"OVERHEATING MOTOR !" "INVERTER ERROR !"	
"INVERTER SERIAL BUS ERROR !"	
"TEMPERATURE SENSOR ERROR"	
"PRESSURE CONTROL FAILURE!"	
"OPENING COVER in RUN!"	
"SPEED METER ERROR"	
"I2C BUS ERROR"	
"OVERHEATING CENTRIFUGE !"	
"ROTOR OVERSPEED !"	
"COVER LOCK MALFUNCTION !"	

12.2 Emergency cover release

	<p>EMERGENCY COVER RELEASE</p> <p>Attention! <i>The cover may be opened in emergency only when the rotor is at rest. Before emergency opening the cover, switch off the mains power switch and disconnect the power cord. Wait 10 min and/or looking through the sight glass, make sure that the rotor is not rotating.</i></p>
	<p>There is a plug on the right-hand side, which must be unscrewed counterclockwise using the emergency lid release key (catalog no. 18640). Then pull on the cap until the cover is open.</p> <p>The emergency opening of the cover can be used, for example, in the event of a power failure, failure of the control panel, etc.</p>

13. Guarantee

Manufacturer grants to the Buyer the guarantee on conditions specified in the Guarantee Certificate. Buyer forfeits the right to guarantee repair when using the device inconsistently with the User manual provisions, when damage results from the User's fault.

Repairs should be carried out in authorized service workshops, granted with the MPW Certificate.

The centrifuge shall be sent to repair after decontaminating disinfections. Information about authorized service workshops could be obtained from the Manufacturer.

	<ul style="list-style-type: none"> ▪ Guarantee period amounts to 24 months (unless otherwise specified in the purchase documents). ▪ Guarantee conditions are described in guaranteed card. ▪ The service life of the centrifuge specified by the manufacturer amounts to 10 years. ▪ After 24 months from the start of the warranty period (date of purchase), a technical inspection of the centrifuge should be carried out (validation) by an authorized service of the manufacturer. Subsequent inspections should be carried out at annual intervals. ▪ Maximum period of storage of not used centrifuge amounts to 1 year. After this period, a service authorized by manufacturer should carry out technical inspection of the centrifuge. ▪ Manufacturer reserves the right to make technical changes in manufactured products.
---	--

14. Transport and storage

	<p>CAUTION! Due to the heavy weight of the device, lifting and carrying it may cause injury to the spine.</p>
<ul style="list-style-type: none"> ▪ Store the device only in a closed and dry room. ▪ Remove rotor from centrifuge before transport. ▪ Lift and carry with the adequate number of people. ▪ Use transport equipment. ▪ Use the original packaging and transport protection for transport. 	

Transport and storage conditions.

	Storage (in the package)	Storage (without the package)	Transport
Temperature	-25 ÷ +55 °C	-5 ÷ +45 °C	-25 ÷ +60 °C (general) -20 ÷ +55 °C (air)
Relative humidity	10 ÷ 75 %	10 ÷ 75 %	10 ÷ 75 %
Pressure	70 ÷ 106 kPa	70 ÷ 106 kPa	30 ÷ 106 kPa

15. Disposal

	<ul style="list-style-type: none"> ▪ Dispose of the device in accordance with the applicable legal regulations in the country of use. ▪ In the countries of the European Community, the disposal of electrical equipment is regulated under the EU Directive 2012/19/EU on waste electrical and electronic equipment (WEEE). According to these regulations, centrifuges may not be collected together with municipal or household waste. ▪ Disposal regulations in individual EU countries may differ. In case of doubt, please contact the supplier of the device.
---	---

16. Manufacturer's info

"MPW MED. INSTRUMENTS" SPÓŁDZIELNIA PRACY

Boremłowska 46 Street

04-347 Warsaw

tel. (+48) 22 610 56 67 (sales department - POLAND)
(+48) 22 879 70 46 (sales department - outside POLAND)
(+48) 22 610 81 07 (service)

fax: (+48) 22 610 55 36

e-mail: mpw@mpw.pl

website: www.mpw.pl

000042924 - number of entries in the Waste Database

PL/CA01-01782 - identification number given by Office for Registration of Medicinal Products, Medical Devices and Biocidal Products.

Distributor's info

DISTRIBUTOR:



17. ANNEXES

A. Wyposażenie dodatkowe/Optional accessories**MPW-260/R/RH****WIRNIK / ROTOR**PARAMETRY WIRNIKA / ROTOR PARAMETERS (RCF [x g], Rmax [mm], α [°])

POJEMNIK/BUCKET

WKŁADKA / ADAPTER

[liczba probówek na wirnik/tubes per rotor] PROBÓWKA / TUBE

11199**RPM 18000 RCF 24270 Rmax 67 α 45**

bez pojemnika/without bucket

bez wkładki/without adapter

[12] * 2-1,5 ml probówka (10,8x41,8 mm), Eppendorf®; [15011], 2 ml (10,8x41,8 mm); [15128], 1,5ml (10,8x40,5 mm)
2-1,5 ml tube (10,8x41,8 mm), Eppendorf®; [15011], 2 ml (10,8x41,8 mm); [15128], 1,5ml (10,8x40,5 mm)

14084

[12] 15127 0,5 ml probówka PCR (7,8 x 31 mm)
0,5 ml PCR tube (7,8 x 31 mm)

14126

[12] 15124 0,4 ml probówka PCR (5,7 x 48,6 mm)
0,4 ml PCR tube (5,7 x 48,6 mm)

14133

[12] 15125 0,2 ml probówka PCR (6 x 21,6 mm)
0,2 ml PCR tube (6 x 21,6 mm)**11213****RPM 5500 RCF 4227 Rmax 125 α 30**

13276

bez wkładki/without adapter

[8] 15051 50 ml Thermo Nalgene® Oak Ridge (28,8 x 106,7 mm)
50 ml Thermo Nalgene® Oak Ridge (28,8 x 106,7 mm)[8] * 50 ml probówka z dnem stożkowym z zakrętką (30 x 117 mm), Falcon®; [15052] 50ml (30 x 117mm)
50 ml tube, conical bottom, with cap (30 x 117 mm), Falcon®; [15052] 50ml Sarstedt® (30 x 117 mm)[8] * 50 ml probówka z dnem stożkowym bez rantu (30 x 115 mm), Greiner®
50 ml tube, conical bottom, without skirt (30 x 115 mm), Greiner®[8] * 50 ml probówka Advanced Oak Ridge (29x102 mm), Herolab® nr 25 32 11
50 ml tube, Advanced Oak Ridge (29 x 102 mm), Herolab® no. 25 32 11

14035

[8] 15046 14 ml probówka z pokrywką (16,8 x 113,7 mm), Sarstedt®
14 ml tube with cap (16,8 x 113,7 mm), Sarstedt®[8] 15048 15 ml Thermo Nalgene® (16 x 113 mm)
15 ml Thermo Nalgene® (16 x 113 mm)[8] 15053 10 ml probówka z pokrywką (16 x 106 mm)
10 ml tube with cap (16 x 106 mm)[8] 15118 10 ml probówka szklana (16 x 100 mm)
10 ml glass tube (16 x 100 mm)

14036

[8] * BD Vacutainer® (13 x 100 mm), (4-7 ml)

[8] * Greiner Vacuette® (13 x 100 mm), (3,5-6 ml)

[8] 15054 6 ml probówka z pokrywką (11,5 x 92 mm), Sarstedt®
6 ml tube with cap (11,5 x 92 mm), Sarstedt®[8] 15119 7 ml probówka szklana (12 x 100 mm)
7 ml glass tube (12 x 100 mm)

14043

[8] * Greiner Vacuette® (13 x 75 mm), (1-4,5 ml)

[8] * Sarstedt S-Monovette® (13 x 75 mm), (2,7; 3; 4,3 ml)

[8] * Sarstedt S-Monovette® (13 x 90 mm), (4,9; 5,6 ml)

[8] 15120 5 ml probówka szklana (12 x 75 mm)
5 ml glass tube (12 x 75 mm)[8] 15419 5 ml probówka z korkiem (12 x 85 mm), Sarstedt®
5 ml tube with cap (12 x 85 mm), Sarstedt®

14071

[8] * 28 ml Thermo Nalgene® Oak Ridge (25,4 x 101,8 mm)

A. Wyposażenie dodatkowe/Optional accessories

MPW-260/R/RH

[8]	15055	30 ml probówka z pokrywką (25,4 x 103,2 mm) 30 ml tube with cap (25,4 x 103,2 mm)
[8]	15056	30 ml Thermo Nalgene® Oak Ridge (25,5 x 94,3 mm) 30 ml Thermo Nalgene® Oak Ridge (25,5 x 94,3 mm)
[8]	15424	30 ml probówka z pokrywką (25,5 x 94 mm), Nalgene® 30 ml tube with cap (25,5 x 94 mm), Nalgene®
14073		
[8]	*	BD Vacutainer® (16 x 100 mm), (2,5-11 ml)
[8]	*	Greiner Vacuette® (16 x 100 mm), (7-9 ml)
[8]	*	Sarstedt S-Monovette® (15 x 92 mm), (7,5; 8,2; 8,5 ml)
[8]	*	Sarstedt S-Monovette® (16 x 92 mm), (9; 10 ml)
[8]	15046	14 ml probówka z pokrywką (16,8 x 113,7 mm), Sarstedt® 14 ml tube with cap (16,8 x 113,7 mm), Sarstedt®
[8]	15053	10 ml probówka z pokrywką (16 x 106 mm) 10 ml tube with cap (16 x 106 mm)
[8]	15118	10 ml probówka szklana (16 x 100 mm) 10 ml glass tube (16 x 100 mm)
14089		
[8]	*	15 ml probówka z dnem stożkowym z zakrętką (17 x 120 mm), Falcon®; [15050], 15ml (17 x 120 mm) 15 ml tube, conical bottom, with cap (17 x 120 mm), Falcon®; [15050] 15ml Sarstedt®(17 x 120 mm)
14248		
[8]	15055	30 ml probówka z pokrywką (25,4 x 103,2 mm) 30 ml tube with cap (25,4 x 103,2 mm)
14089+14868		
[8]	*	5 ml probówka z korkiem wciskany (17 x 54,2 mm), Eppendorf® 5 ml tube with snap cap (17 x 54,2 mm), Eppendorf®
[8]	*	5 ml probówka z korkiem zakręcany (17 x 66 mm), Eppendorf® 5 ml tube with screw cap (17 x 66 mm), Eppendorf®
13278+17151		
bez wkładki/without adapter		
[8]	15051	50 ml Thermo Nalgene® Oak Ridge (28,8 x 106,7 mm) 50 ml Thermo Nalgene® Oak Ridge (28,8 x 106,7 mm)
[8]	*	50 ml probówka z dnem stożkowym z zakrętką (30 x 117 mm), Falcon®; [15052] 50ml (30 x 117mm) 50 ml tube, conical bottom, with cap (30 x 117 mm), Falcon®; [15052] 50ml Sarstedt® (30 x 117 mm)
[8]	*	50 ml probówka z dnem stożkowym bez rantu (30 x 115 mm), Greiner® 50 ml tube, conical bottom, without skirt (30 x 115 mm), Greiner®
[8]	*	50 ml probówka Advanced Oak Ridge (29x102 mm), Herolab® nr 25 32 11 50 ml tube, Advanced Oak Ridge (29 x 102 mm), Herolab® no. 25 32 11
14035		
[8]	15046	14 ml probówka z pokrywką (16,8 x 113,7 mm), Sarstedt® 14 ml tube with cap (16,8 x 113,7 mm), Sarstedt®
[8]	15048	15 ml Thermo Nalgene® (16 x 113 mm) 15 ml Thermo Nalgene® (16 x 113 mm)
[8]	15053	10 ml probówka z pokrywką (16 x 106 mm) 10 ml tube with cap (16 x 106 mm)
[8]	15118	10 ml probówka szklana (16 x 100 mm) 10 ml glass tube (16 x 100 mm)
14036		
[8]	15054	6 ml probówka z pokrywką (11,5 x 92 mm), Sarstedt® 6 ml tube with cap (11,5 x 92 mm), Sarstedt®
[8]	15119	7 ml probówka szklana (12 x 100 mm) 7 ml glass tube (12 x 100 mm)
14043		
[8]	*	Greiner Vacuette® (13 x 75 mm), (1-4,5 ml)
[8]	15120	5 ml probówka szklana (12 x 75 mm) 5 ml glass tube (12 x 75 mm)
[8]	15419	5 ml probówka z korkiem (12 x 85 mm), Sarstedt® 5 ml tube with cap (12 x 85 mm), Sarstedt®
14071		
[8]	*	28 ml Thermo Nalgene® Oak Ridge (25,4 x 101,8 mm)
[8]	15055	30 ml probówka z pokrywką (25,4 x 103,2 mm) 30 ml tube with cap (25,4 x 103,2 mm)
[8]	15056	30 ml Thermo Nalgene® Oak Ridge (25,5 x 94,3 mm) 30 ml Thermo Nalgene® Oak Ridge (25,5 x 94,3 mm)
[8]	15424	30 ml probówka z pokrywką (25,5 x 94 mm), Nalgene® 30 ml tube with cap (25,5 x 94 mm), Nalgene®
14073		
[8]	*	BD Vacutainer® (16 x 100 mm), (2,5-11 ml)
[8]	*	Greiner Vacuette® (16 x 100 mm), (7-9 ml)
[8]	*	Sarstedt S-Monovette® (15 x 92 mm), (7,5; 8,2; 8,5 ml)

A. Wyposażenie dodatkowe/Optional accessories**MPW-260/R/RH**

[8]	*	Sarstedt S-Monovette® (16 x 92 mm), (9; 10 ml)
[8]	15046	14 ml probówka z pokrywką (16,8 x 113,7 mm), Sarstedt® 14 ml tube with cap (16,8 x 113,7 mm), Sarstedt®
[8]	15053	10 ml probówka z pokrywką (16 x 106 mm) 10 ml tube with cap (16 x 106 mm)
[8]	15118	10 ml probówka szklana (16 x 100 mm) 10 ml glass tube (16 x 100 mm)
		14089
[8]	*	15 ml probówka z dnem stożkowym z zakrętką (17 x 120 mm), Falcon®; [15050], 15ml (17 x 120 mm) 15 ml tube, conical bottom, with cap (17 x 120 mm), Falcon®; [15050] 15ml Sarstedt®(17 x 120 mm)
		14248
[8]	15055	30 ml probówka z pokrywką (25,4 x 103,2 mm) 30 ml tube with cap (25,4 x 103,2 mm)
		14089+14868
[8]	*	5 ml probówka z korkiem wciskany (17 x 54,2 mm), Eppendorf® 5 ml tube with snap cap (17 x 54,2 mm), Eppendorf®

11216**RPM 14000 RCF 19064 Rmax 87 ϕ 45**

bez pojemnika/without bucket

bez wkładki/without adapter

[12]	15419	5 ml probówka z korkiem (12 x 85 mm), Sarstedt® 5 ml tube with cap (12 x 85 mm), Sarstedt®
------	-------	---

11217**RPM 6000 RCF 3502 Rmax 87 ϕ 30**

13080

14082+14815

[10]	15120	5 ml probówka szklana (12 x 75 mm) 5 ml glass tube (12 x 75 mm)
		14082+14815 Rmax 87 RCF 3502
[10]	*	Greiner Vacuette® (13 x 75 mm), (1-4,5 ml)
[10]	*	Sarstedt S-Monovette® (13 x 75 mm), (2,7; 3; 4,3 ml)
[10]	*	BD Vacutainer® (13 x 75 mm), (1,6-5,3 ml)
[10]	*	Sarstedt S-Monovette® (11 x 66 mm), (1,6; 2; 2,7; 3; 3,1 ml)
[10]	*	Sarstedt S-Monovette® (13 x 65 mm), (2,6; 2,9; 3,4; 3,8 ml)
		14815 Rmax 87 RCF 3502
[10]	*	Sarstedt S-Monovette® (15 x 75 mm), (4; 4,3; 5,5 ml)
[10]	*	10 ml Thermo Nalgene® Oak Ridge (16 x 81,5 mm)
[10]	15121	10 ml probówka z dnem okrągłym i pokrywką (17 x 70 mm) 10 ml tube, round bottom, with cap (17 x 70 mm)

11217**RPM 6000 RCF 4226 Rmax 105 ϕ 30**

13080

14082

[10]	*	BD Vacutainer® (13 x 100 mm), (4-7 ml)
[10]	*	Greiner Vacuette® (13 x 100 mm), (3,5-6 ml)
[10]	*	Sarstedt S-Monovette® (11 x 92 mm), (4,5; 5 ml)
[10]	15054	6 ml probówka z pokrywką (11,5 x 92 mm), Sarstedt® 6 ml tube with cap (11,5 x 92 mm), Sarstedt®
[10]	15119	7 ml probówka szklana (12 x 100 mm) 7 ml glass tube (12 x 100 mm)
		bez wkładki/without adapter
[10]	*	Greiner Vacuette® (16 x 100 mm), (7-9 ml)
[10]	*	Sarstedt S-Monovette® (15 x 92 mm), (7,5; 8,2; 8,5 ml)
[10]	*	BD Vacutainer® (16 x 100 mm), (2,5-11 ml)
[10]	*	Sarstedt S-Monovette® (16 x 92 mm), (9; 10 ml)
[10]	15046	14 ml probówka z pokrywką (16,8 x 113,7 mm), Sarstedt® 14 ml tube with cap (16,8 x 113,7 mm), Sarstedt®
[10]	15048	15 ml Thermo Nalgene® (16 x 113 mm) 15 ml Thermo Nalgene® (16 x 113 mm)
[10]	15053	10 ml probówka z pokrywką (16 x 106 mm) 10 ml tube with cap (16 x 106 mm)
[10]	15118	10 ml probówka szklana (16 x 100 mm) 10 ml glass tube (16 x 100 mm)

A. Wyposażenie dodatkowe/Optional accessories
MPW-260/R/RH

[10] * 15 ml probówka z dnem stożkowym z zakrętką (17 x 120 mm), Falcon®; [15050], 15ml (17 x 120 mm)
15 ml tube, conical bottom, with cap (17 x 120 mm), Falcon®; [15050] 15ml Sarstedt®(17 x 120 mm)

11461
RPM 15100 RCF 21158 Rmax 83 \varnothing 45

bez pojemnika/without bucket R max 83 RCF 21158 x g

14084 Rmax 83 RCF 21158

[24] 15127 0,5 ml probówka PCR (7,8 x 31 mm)
0,5 ml PCR tube (7,8 x 31 mm)

14126 Rmax 83 RCF 21158

[24] 15124 0,4 ml probówka PCR (5,7 x 48,6 mm)
0,4 ml PCR tube (5,7 x 48,6 mm)

14133 Rmax 83 RCF 21158

[24] 15125 0,2 ml probówka PCR (6 x 21,6 mm)
0,2 ml PCR tube (6 x 21,6 mm)

bez wkładki/without adapter Rmax 83 RCF 21158

[24] * 2-1,5 ml probówka (10,8x41,8 mm), Eppendorf®; [15011], 2 ml (10,8x41,8 mm); [15128], 1,5ml (10,8x40,5 mm)
2-1,5 ml tube (10,8x41,8 mm), Eppendorf®; [15011], 2 ml (10,8x41,8 mm); [15128], 1,5ml (10,8x40,5 mm)

11462
RPM 14000 RCF 18188 Rmax 83 \varnothing 45

bez pojemnika/without bucket R max 83 RCF 18188 x g

14084 Rmax 83 RCF 18188

[36] 15127 0,5 ml probówka PCR (7,8 x 31 mm)
0,5 ml PCR tube (7,8 x 31 mm)

14126 Rmax 83 RCF 18188

[36] 15124 0,4 ml probówka PCR (5,7 x 48,6 mm)
0,4 ml PCR tube (5,7 x 48,6 mm)

14133 Rmax 83 RCF 18188

[36] 15125 0,2 ml probówka PCR (6 x 21,6 mm)
0,2 ml PCR tube (6 x 21,6 mm)

bez wkładki/without adapter Rmax 83 RCF 18188

[36] * 2-1,5 ml probówka (10,8x41,8 mm), Eppendorf®; [15011], 2 ml (10,8x41,8 mm); [15128], 1,5ml (10,8x40,5 mm)
2-1,5 ml tube (10,8x41,8 mm), Eppendorf®; [15011], 2 ml (10,8x41,8 mm); [15128], 1,5ml (10,8x40,5 mm)

11501
RPM 4500 RCF 2717 Rmax 120 \varnothing 30

13080

14082+14815 Rmax 120 RCF 2717

[30] * BD Vacutainer® (13 x 75 mm), (1,6-5,3 ml)

[30] * Greiner Vacuette® (13 x 75 mm), (1-4,5 ml)

[30] * Sarstedt S-Monovette® (11 x 66 mm), (1,6; 2; 2,7; 3; 3,1 ml)

[30] * Sarstedt S-Monovette® (13 x 65 mm), (2,6; 2,9; 3,4; 3,8 ml)

[30] * Sarstedt S-Monovette® (13 x 75 mm), (2,7; 3; 4,3 ml)

[30] 15120 5 ml probówka szklana (12 x 75 mm)
5 ml glass tube (12 x 75 mm)

14815 Rmax 120 RCF 2717

[30] * Sarstedt S-Monovette® (15 x 75 mm), (4; 4,3; 5,5 ml)

[30] * 10 ml Thermo Nalgene® Oak Ridge (16 x 81,5 mm)

[30] 15121 10 ml probówka z dnem okrągłym i pokrywką (17 x 70 mm)
10 ml tube, round bottom, with cap (17 x 70 mm)

11501
RPM 4500 RCF 2966 Rmax 131 \varnothing 30

13080 R max 131 RCF 2966 x g

14082 Rmax 131 RCF 2966

[30] * BD Vacutainer® (13 x 100 mm), (4-7 ml)

[30] * Greiner Vacuette® (13 x 100 mm), (3,5-6 ml)

[30] * Sarstedt S-Monovette® (11 x 92 mm), (4,5; 5 ml)

[30] 15054 6 ml probówka z pokrywką (11,5 x 92 mm), Sarstedt®
6 ml tube with cap (11,5 x 92 mm), Sarstedt®

[30] 15119 7 ml probówka szklana (12 x 100 mm)
7 ml glass tube (12 x 100 mm)

bez wkładki/without adapter Rmax 131 RCF 2966

[30] * BD Vacutainer® (16 x 100 mm), (2,5-11 ml)

[30] * Greiner Vacuette® (16 x 100 mm), (7-9 ml)

A. Wyposażenie dodatkowe/Optional accessories**MPW-260/R/RH**

[30]	*	Sarstedt S-Monovette® (15 x 92 mm), (7,5; 8,2; 8,5 ml)
[30]	*	Sarstedt S-Monovette® (16 x 92 mm), (9; 10 ml)
[30]	15046	14 ml probówka z pokrywką (16,8 x 113,7 mm), Sarstedt® 14 ml tube with cap (16,8 x 113,7 mm), Sarstedt®
[30]	15048	15 ml Thermo Nalgene® (16 x 113 mm) 15 ml Thermo Nalgene® (16 x 113 mm)
[30]	15053	10 ml probówka z pokrywką (16 x 106 mm) 10 ml tube with cap (16 x 106 mm)
[30]	15118	10 ml probówka szklana (16 x 100 mm) 10 ml glass tube (16 x 100 mm)
[30]	*	15 ml probówka z dnem stożkowym z zakrętką (17 x 120 mm), Falcon®; [15050], 15ml (17 x 120 mm) 15 ml tube, conical bottom, with cap (17 x 120 mm), Falcon®; [15050] 15ml Sarstedt®(17 x 120 mm)

11715**RPM 14000 RCF 15558 Rmax 71 ϕ 30**

bez pojemnika/without bucket

bez wkładki/without adapter

[10]	15121	10 ml probówka z dnem okrągłym i pokrywką (17 x 70 mm) 10 ml tube, round bottom, with cap (17 x 70 mm)
------	-------	---

11716**RPM 14000 RCF 15339 Rmax 70 ϕ 45**

bez pojemnika/without bucket R max 70 RCF 15339 x g

bez wkładki/without adapter Rmax 70 RCF 15339

[4]	15131	4 x 0,2 ml probówki szeregowo PCR-strip (10,2 x 37,2 mm) 4 x 0,2 ml PCR strip (10,2 x 37,2 mm)
[4]	15122	8 x 0,2 ml probówki szeregowo PCR-strip (10,2 x 72,4 mm) 8 x 0,2 ml PCR strip (10,2 x 72,4 mm)
[32]	15125	0,2 ml probówka PCR (6 x 21,6 mm) 0,2 ml PCR tube (6 x 21,6 mm)
[4]	15130	8 x 0,2 ml probówki szeregowo PCR strip (7,3 x 77,2 mm) 8 x 0,2 ml PCR strip (7,3 x 77,2 mm)

11718**RPM 6300 RCF 5014 Rmax 113 ϕ 30**

13719

14024

[4]	*	15 ml probówka z dnem stożkowym z zakrętką (17 x 120 mm), Falcon®; [15050], 15ml (17 x 120 mm) 15 ml tube, conical bottom, with cap (17 x 120 mm), Falcon®; [15050] 15ml Sarstedt®(17 x 120 mm)
-----	---	--

14196

[4]	15040	100 ml probówka z pokrywką (45,2 x 103,7 mm) 100 ml tube with cap (45,2 x 103,7 mm)
-----	-------	--

14224

[4]	15056	30 ml Thermo Nalgene® Oak Ridge (25,5 x 94,3 mm) 30 ml Thermo Nalgene® Oak Ridge (25,5 x 94,3 mm)
-----	-------	--

[4]	15055	30 ml probówka z pokrywką (25,4 x 103,2 mm) 30 ml tube with cap (25,4 x 103,2 mm)
-----	-------	--

[4]	15222	30 ml probówka z pokrywką (25 x 94mm), Sterilin® 30 ml tube with cap (25 x 94 mm), Sterilin®
-----	-------	---

[4]	15223	30 ml probówka z pokrywką (25 x 94 mm), Sterilin® 30 ml tube with cap (25 x 94 mm), Sterilin®
-----	-------	--

14226

[4]	*	50 ml probówka z dnem stożkowym z rantem (30 x 115 mm), Greiner® 50 ml tube, conical bottom, skirted (30 x 115 mm), Greiner®
-----	---	---

14189+14188

[4]	15051	50 ml Thermo Nalgene® Oak Ridge (28,8 x 106,7 mm) 50 ml Thermo Nalgene® Oak Ridge (28,8 x 106,7 mm)
-----	-------	--

[4]	*	50 ml probówka z dnem stożkowym z zakrętką (30 x 117 mm), Falcon®; [15052] 50ml (30 x 117mm) 50 ml tube, conical bottom, with cap (30 x 117 mm), Falcon®; [15052] 50ml Sarstedt® (30 x 117 mm)
-----	---	---

[4]	*	50 ml probówka z dnem stożkowym bez rantu (30 x 115 mm), Greiner® 50 ml tube, conical bottom, without skirt (30 x 115 mm), Greiner®
-----	---	--

[4]	*	50 ml probówka Advanced Oak Ridge (29x102 mm), Herolab® nr 25 32 11 50 ml tube, Advanced Oak Ridge (29 x 102 mm), Herolab® no. 25 32 11
-----	---	--

14190+14188

[4]	15055	30 ml probówka z pokrywką (25,4 x 103,2 mm) 30 ml tube with cap (25,4 x 103,2 mm)
-----	-------	--

11740**RPM 5500 RCF 3416 Rmax 101 ϕ 30**

A. Wyposażenie dodatkowe/Optional accessories**MPW-260/R/RH**

13080

14082+14815

[12] 15120 5 ml probówka szklana (12 x 75 mm)
5 ml glass tube (12 x 75 mm)

14082+14815 Rmax 101 RCF 3416

[12] * BD Vacutainer® (13 x 75 mm), (1,6-5,3 ml)
[12] * Greiner Vacuette® (13 x 75 mm), (1-4,5 ml)
[12] * Sarstedt S-Monovette® (11 x 66 mm), (1,6; 2; 2,7; 3; 3,1 ml)
[12] * Sarstedt S-Monovette® (13 x 65 mm), (2,6; 2,9; 3,4; 3,8 ml)
[12] * Sarstedt S-Monovette® (13 x 75 mm), (2,7; 3; 4,3 ml)

14815 Rmax 101 RCF 3416

[12] * Sarstedt S-Monovette® (15 x 75 mm), (4; 4,3; 5,5 ml)
[12] * 10 ml Thermo Nalgene® Oak Ridge (16 x 81,5 mm)
[12] 15121 10 ml probówka z dnem okrągłym i pokrywką (17 x 70 mm)
10 ml tube, round bottom, with cap (17 x 70 mm)

11740**RPM 5500 RCF 4058 Rmax 120 \pm 30**

13080

14082

[12] * BD Vacutainer® (13 x 100 mm), (4-7 ml)
[12] * Greiner Vacuette® (13 x 100 mm), (3,5-6 ml)
[12] * Sarstedt S-Monovette® (11 x 92 mm), (4,5; 5 ml)
[12] 15054 6 ml probówka z pokrywką (11,5 x 92 mm), Sarstedt®
6 ml tube with cap (11,5 x 92 mm), Sarstedt®
[12] 15119 7 ml probówka szklana (12 x 100 mm)
7 ml glass tube (12 x 100 mm)

bez wkładki/without adapter

[12] * BD Vacutainer® (16 x 100 mm), (2,5-11 ml)
[12] * Greiner Vacuette® (16 x 100 mm), (7-9 ml)
[12] * Sarstedt S-Monovette® (15 x 92 mm), (7,5; 8,2; 8,5 ml)
[12] * Sarstedt S-Monovette® (16 x 92 mm), (9; 10 ml)
[12] 15046 14 ml probówka z pokrywką (16,8 x 113,7 mm), Sarstedt®
14 ml tube with cap (16,8 x 113,7 mm), Sarstedt®
[12] 15048 15 ml Thermo Nalgene® (16 x 113 mm)
15 ml Thermo Nalgene® (16 x 113 mm)
[12] 15053 10 ml probówka z pokrywką (16 x 106 mm)
10 ml tube with cap (16 x 106 mm)
[12] 15118 10 ml probówka szklana (16 x 100 mm)
10 ml glass tube (16 x 100 mm)
[12] * 15 ml probówka z dnem stożkowym z zakrętką (17 x 120 mm), Falcon®; [15050], 15ml (17 x 120 mm)
15 ml tube, conical bottom, with cap (17 x 120 mm), Falcon®; [15050] 15ml Sarstedt®(17 x 120 mm)

11741**RPM 6000 RCF 3502 Rmax 87 \pm 30**

13080

14082+14815

[8] 15120 5 ml probówka szklana (12 x 75 mm)
5 ml glass tube (12 x 75 mm)

14082+14815 Rmax 87 RCF 3502

[8] * BD Vacutainer® (13 x 75 mm), (1,6-5,3 ml)
[8] * Greiner Vacuette® (13 x 75 mm), (1-4,5 ml)
[8] * Sarstedt S-Monovette® (11 x 66 mm), (1,6; 2; 2,7; 3; 3,1 ml)
[8] * Sarstedt S-Monovette® (13 x 65 mm), (2,6; 2,9; 3,4; 3,8 ml)
[8] * Sarstedt S-Monovette® (13 x 75 mm), (2,7; 3; 4,3 ml)

14815 Rmax 87 RCF 3502

[8] * Sarstedt S-Monovette® (15 x 75 mm), (4; 4,3; 5,5 ml)
[8] * 10 ml Thermo Nalgene® Oak Ridge (16 x 81,5 mm)
[8] 15121 10 ml probówka z dnem okrągłym i pokrywką (17 x 70 mm)
10 ml tube, round bottom, with cap (17 x 70 mm)

11741**RPM 6000 RCF 4226 Rmax 105 \pm 30**

13080

14082

A. Wyposażenie dodatkowe/Optional accessories**MPW-260/R/RH**

[8]	*	BD Vacutainer® (13 x 100 mm), (4-7 ml)
[8]	*	Greiner Vacuette® (13 x 100 mm), (3,5-6 ml)
[8]	*	Sarstedt S-Monovette® (11 x 92 mm), (4,5; 5 ml)
[8]	15054	6 ml probówka z pokrywką (11,5 x 92 mm), Sarstedt® 6 ml tube with cap (11,5 x 92 mm), Sarstedt®
[8]	15119	7 ml probówka szklana (12 x 100 mm) 7 ml glass tube (12 x 100 mm)
bez wkładki/without adapter		
[8]	*	BD Vacutainer® (16 x 100 mm), (2,5-11 ml)
[8]	*	Greiner Vacuette® (16 x 100 mm), (7-9 ml)
[8]	*	Sarstedt S-Monovette® (15 x 92 mm), (7,5; 8,2; 8,5 ml)
[8]	*	Sarstedt S-Monovette® (16 x 92 mm), (9; 10 ml)
[8]	15046	14 ml probówka z pokrywką (16,8 x 113,7 mm), Sarstedt® 14 ml tube with cap (16,8 x 113,7 mm), Sarstedt®
[8]	15048	15 ml Thermo Nalgene® (16 x 113 mm) 15 ml Thermo Nalgene® (16 x 113 mm)
[8]	15053	10 ml probówka z pokrywką (16 x 106 mm) 10 ml tube with cap (16 x 106 mm)
[8]	15118	10 ml probówka szklana (16 x 100 mm) 10 ml glass tube (16 x 100 mm)
[8]	*	15 ml probówka z dnem stożkowym z zakrętką (17 x 120 mm), Falcon®; [15050], 15ml (17 x 120 mm) 15 ml tube, conical bottom, with cap (17 x 120 mm), Falcon®; [15050] 15ml Sarstedt®(17 x 120 mm)

11743**RPM 4500 RCF 2604 Rmax 115 \pm 30**

13329 R max 115 RCF 2604 x g		
14256 Rmax 115 RCF 2604		
[12]	15046	14 ml probówka z pokrywką (16,8 x 113,7 mm), Sarstedt® 14 ml tube with cap (16,8 x 113,7 mm), Sarstedt®
[12]	15048	15 ml Thermo Nalgene® (16 x 113 mm) 15 ml Thermo Nalgene® (16 x 113 mm)
[12]	15053	10 ml probówka z pokrywką (16 x 106 mm) 10 ml tube with cap (16 x 106 mm)
[12]	15118	10 ml probówka szklana (16 x 100 mm) 10 ml glass tube (16 x 100 mm)
14255 Rmax 115 RCF 2604		
[12]	*	Sarstedt S-Monovette® (11 x 92 mm), (4,5; 5 ml)
[12]	15119	7 ml probówka szklana (12 x 100 mm) 7 ml glass tube (12 x 100 mm)
bez wkładki/without adapter Rmax 115 RCF 2604		
[12]	15055	30 ml probówka z pokrywką (25,4 x 103,2 mm) 30 ml tube with cap (25,4 x 103,2 mm)
[12]	15424	30 ml probówka z pokrywką (25,5 x 94 mm), Nalgene® 30 ml tube with cap (25,5 x 94 mm), Nalgene®
[12]	15222	30 ml probówka z pokrywką (25 x 94mm), Sterilin® 30 ml tube with cap (25 x 94 mm), Sterilin®
[12]	15223	30 ml probówka z pokrywką (25 x 94 mm), Sterilin® 30 ml tube with cap (25 x 94 mm), Sterilin®

11744**RPM 4500 RCF 2830 Rmax 125 \pm 30**

13276		
bez wkładki/without adapter		
[10]	15051	50 ml Thermo Nalgene® Oak Ridge (28,8 x 106,7 mm) 50 ml Thermo Nalgene® Oak Ridge (28,8 x 106,7 mm)
[10]	*	50 ml probówka z dnem stożkowym z zakrętką (30 x 117 mm), Falcon®; [15052] 50ml (30 x 117mm) 50 ml tube, conical bottom, with cap (30 x 117 mm), Falcon®; [15052] 50ml Sarstedt® (30 x 117 mm)
[10]	*	50 ml probówka z dnem stożkowym bez rantu (30 x 115 mm), Greiner® 50 ml tube, conical bottom, without skirt (30 x 115 mm), Greiner®
[10]	*	50 ml probówka Advanced Oak Ridge (29x102 mm), Herolab® nr 25 32 11 50 ml tube, Advanced Oak Ridge (29 x 102 mm), Herolab® no. 25 32 11
14035		
[10]	15046	14 ml probówka z pokrywką (16,8 x 113,7 mm), Sarstedt® 14 ml tube with cap (16,8 x 113,7 mm), Sarstedt®
[10]	15048	15 ml Thermo Nalgene® (16 x 113 mm) 15 ml Thermo Nalgene® (16 x 113 mm)
[10]	15053	10 ml probówka z pokrywką (16 x 106 mm) 10 ml tube with cap (16 x 106 mm)
[10]	15118	10 ml probówka szklana (16 x 100 mm) 10 ml glass tube (16 x 100 mm)

A. Wyposażenie dodatkowe/Optional accessories**MPW-260/R/RH****14036**

- [10] * BD Vacutainer® (13 x 100 mm), (4-7 ml)
 [10] * Greiner Vacuette® (13 x 100 mm), (3,5-6 ml)
 [10] 15054 6 ml probówka z pokrywką (11,5 x 92 mm), Sarstedt®
 6 ml tube with cap (11,5 x 92 mm), Sarstedt®
 [10] 15119 7 ml probówka szklana (12 x 100 mm)
 7 ml glass tube (12 x 100 mm)

14043

- [10] * Greiner Vacuette® (13 x 75 mm), (1-4,5 ml)
 [10] * Sarstedt S-Monovette® (13 x 75 mm), (2,7; 3; 4,3 ml)
 [10] * Sarstedt S-Monovette® (13 x 90 mm), (4,9; 5,6 ml)
 [10] 15120 5 ml probówka szklana (12 x 75 mm)
 5 ml glass tube (12 x 75 mm)
 [10] 15419 5 ml probówka z korkiem (12 x 85 mm), Sarstedt®
 5 ml tube with cap (12 x 85 mm), Sarstedt®

14071

- [10] * 28 ml Thermo Nalgene® Oak Ridge (25,4 x 101,8 mm)
 [10] 15055 30 ml probówka z pokrywką (25,4 x 103,2 mm)
 30 ml tube with cap (25,4 x 103,2 mm)
 [10] 15056 30 ml Thermo Nalgene® Oak Ridge (25,5 x 94,3 mm)
 30 ml Thermo Nalgene® Oak Ridge (25,5 x 94,3 mm)
 [10] 15424 30 ml probówka z pokrywką (25,5 x 94 mm), Nalgene®
 30 ml tube with cap (25,5 x 94 mm), Nalgene®

14073

- [10] * Greiner Vacuette® (16 x 100 mm), (7-9 ml)
 [10] * Sarstedt S-Monovette® (15 x 92 mm), (7,5; 8,2; 8,5 ml)
 [10] * BD Vacutainer® (16 x 100 mm), (2,5-11 ml)
 [10] * Sarstedt S-Monovette® (16 x 92 mm), (9; 10 ml)
 [10] 15046 14 ml probówka z pokrywką (16,8 x 113,7 mm), Sarstedt®
 14 ml tube with cap (16,8 x 113,7 mm), Sarstedt®
 [10] 15048 15 ml Thermo Nalgene® (16 x 113 mm)
 15 ml Thermo Nalgene® (16 x 113 mm)
 [10] 15053 10 ml probówka z pokrywką (16 x 106 mm)
 10 ml tube with cap (16 x 106 mm)
 [10] 15118 10 ml probówka szklana (16 x 100 mm)
 10 ml glass tube (16 x 100 mm)

14089

- [10] * 15 ml probówka z dnem stożkowym z zakrętką (17 x 120 mm), Falcon®; [15050], 15ml (17 x 120 mm)
 15 ml tube, conical bottom, with cap (17 x 120 mm), Falcon®; [15050] 15ml Sarstedt®(17 x 120 mm)

14248

- [10] 15055 30 ml probówka z pokrywką (25,4 x 103,2 mm)
 30 ml tube with cap (25,4 x 103,2 mm)

14089+14868

- [10] * 5 ml probówka z korkiem wciskany (17 x 54,2 mm), Eppendorf®
 5 ml tube with snap cap (17 x 54,2 mm), Eppendorf®
 [10] * 5 ml probówka z korkiem zakręcany (17 x 66 mm), Eppendorf®
 5 ml tube with screw cap (17 x 66 mm), Eppendorf®

11745**RPM 5000 RCF 2935 Rmax 105 \pm 30****13080****14082+14815 Rmax 105 RCF 2935**

- [24] * BD Vacutainer® (13 x 75 mm), (1,6-5,3 ml)
 [24] * Greiner Vacuette® (13 x 75 mm), (1-4,5 ml)
 [24] * Sarstedt S-Monovette® (11 x 66 mm), (1,6; 2; 2,7; 3; 3,1 ml)
 [24] * Sarstedt S-Monovette® (13 x 65 mm), (2,6; 2,9; 3,4; 3,8 ml)
 [24] * Sarstedt S-Monovette® (13 x 75 mm), (2,7; 3; 4,3 ml)
 [24] 15120 5 ml probówka szklana (12 x 75 mm)
 5 ml glass tube (12 x 75 mm)

14815 Rmax 105 RCF 2935

- [24] * Sarstedt S-Monovette® (15 x 75 mm), (4; 4,3; 5,5 ml)
 [24] * 10 ml Thermo Nalgene® Oak Ridge (16 x 81,5 mm)
 [24] 15121 10 ml probówka z dnem okrągłym i pokrywką (17 x 70 mm)
 10 ml tube, round bottom, with cap (17 x 70 mm)

11745**RPM 5000 RCF 3354 Rmax 120 \pm 30****13080**

A. Wyposażenie dodatkowe/Optional accessories**MPW-260/R/RH****14082**

- [24] * BD Vacutainer® (13 x 100 mm), (4-7 ml)
 [24] * Greiner Vacuette® (13 x 100 mm), (3,5-6 ml)
 [24] * Sarstedt S-Monovette® (11 x 92 mm), (4,5; 5 ml)
 [24] 15054 6 ml probówka z pokrywką (11,5 x 92 mm), Sarstedt®
 6 ml tube with cap (11,5 x 92 mm), Sarstedt®
 [24] 15119 7 ml probówka szklana (12 x 100 mm)
 7 ml glass tube (12 x 100 mm)

bez wkładki/without adapter

- [24] * BD Vacutainer® (16 x 100 mm), (2,5-11 ml)
 [24] * Greiner Vacuette® (16 x 100 mm), (7-9 ml)
 [24] * Sarstedt S-Monovette® (15 x 92 mm), (7,5; 8,2; 8,5 ml)
 [24] * Sarstedt S-Monovette® (16 x 92 mm), (9; 10 ml)
 [24] 15046 14 ml probówka z pokrywką (16,8 x 113,7 mm), Sarstedt®
 14 ml tube with cap (16,8 x 113,7 mm), Sarstedt®
 [24] 15048 15 ml Thermo Nalgene® (16 x 113 mm)
 15 ml Thermo Nalgene® (16 x 113 mm)
 [24] 15053 10 ml probówka z pokrywką (16 x 106 mm)
 10 ml tube with cap (16 x 106 mm)
 [24] 15118 10 ml probówka szklana (16 x 100 mm)
 10 ml glass tube (16 x 100 mm)
 [24] * 15 ml probówka z dnem stożkowym z zakrętką (17 x 120 mm), Falcon®; [15050], 15ml (17 x 120 mm)
 15 ml tube, conical bottom, with cap (17 x 120 mm), Falcon®; [15050] 15ml Sarstedt®(17 x 120 mm)

11746**RPM 6000 RCF 4427 Rmax 110 \pm 30****13276****bez wkładki/without adapter**

- [6] * 50 ml probówka z dnem stożkowym z zakrętką (30 x 117 mm), Falcon®; [15052] 50ml (30 x 117mm)
 50 ml tube, conical bottom, with cap (30 x 117 mm), Falcon®; [15052] 50ml Sarstedt® (30 x 117 mm)
 [6] * 50 ml probówka z dnem stożkowym bez rantu (30 x 115 mm), Greiner®
 50 ml tube, conical bottom, without skirt (30 x 115 mm), Greiner®
 [6] 15051 50 ml Thermo Nalgene® Oak Ridge (28,8 x 106,7 mm)
 50 ml Thermo Nalgene® Oak Ridge (28,8 x 106,7 mm)
 [6] * 50 ml probówka Advanced Oak Ridge (29x102 mm), Herolab® nr 25 32 11
 50 ml tube, Advanced Oak Ridge (29 x 102 mm), Herolab® no. 25 32 11

14035

- [6] 15046 14 ml probówka z pokrywką (16,8 x 113,7 mm), Sarstedt®
 14 ml tube with cap (16,8 x 113,7 mm), Sarstedt®
 [6] 15048 15 ml Thermo Nalgene® (16 x 113 mm)
 15 ml Thermo Nalgene® (16 x 113 mm)
 [6] 15053 10 ml probówka z pokrywką (16 x 106 mm)
 10 ml tube with cap (16 x 106 mm)
 [6] 15118 10 ml probówka szklana (16 x 100 mm)
 10 ml glass tube (16 x 100 mm)

14036

- [6] * BD Vacutainer® (13 x 100 mm), (4-7 ml)
 [6] * Greiner Vacuette® (13 x 100 mm), (3,5-6 ml)
 [6] 15054 6 ml probówka z pokrywką (11,5 x 92 mm), Sarstedt®
 6 ml tube with cap (11,5 x 92 mm), Sarstedt®
 [6] 15119 7 ml probówka szklana (12 x 100 mm)
 7 ml glass tube (12 x 100 mm)

14043

- [6] * Greiner Vacuette® (13 x 75 mm), (1-4,5 ml)
 [6] * Sarstedt S-Monovette® (13 x 75 mm), (2,7; 3; 4,3 ml)
 [6] * Sarstedt S-Monovette® (13 x 90 mm), (4,9; 5,6 ml)
 [6] 15120 5 ml probówka szklana (12 x 75 mm)
 5 ml glass tube (12 x 75 mm)
 [6] 15419 5 ml probówka z korkiem (12 x 85 mm), Sarstedt®
 5 ml tube with cap (12 x 85 mm), Sarstedt®

14071

- [6] * 28 ml Thermo Nalgene® Oak Ridge (25,4 x 101,8 mm)
 [6] 15055 30 ml probówka z pokrywką (25,4 x 103,2 mm)
 30 ml tube with cap (25,4 x 103,2 mm)
 [6] 15056 30 ml Thermo Nalgene® Oak Ridge (25,5 x 94,3 mm)
 30 ml Thermo Nalgene® Oak Ridge (25,5 x 94,3 mm)
 [6] 15424 30 ml probówka z pokrywką (25,5 x 94 mm), Nalgene®
 30 ml tube with cap (25,5 x 94 mm), Nalgene®

14073

- [6] * BD Vacutainer® (16 x 100 mm), (2,5-11 ml)

A. Wyposażenie dodatkowe/Optional accessories**MPW-260/R/RH**

[6]	*	Greiner Vacuette® (16 x 100 mm), (7-9 ml)
[6]	*	Sarstedt S-Monovette® (15 x 92 mm), (7,5; 8,2; 8,5 ml)
[6]	*	Sarstedt S-Monovette® (16 x 92 mm), (9; 10 ml)
[6]	15046	14 ml probówka z pokrywką (16,8 x 113,7 mm), Sarstedt® 14 ml tube with cap (16,8 x 113,7 mm), Sarstedt®
[6]	15053	10 ml probówka z pokrywką (16 x 106 mm) 10 ml tube with cap (16 x 106 mm)
[6]	15118	10 ml probówka szklana (16 x 100 mm) 10 ml glass tube (16 x 100 mm)

14089

[6]	*	15 ml probówka z dnem stożkowym z zakrętką (17 x 120 mm), Falcon®; [15050], 15ml (17 x 120 mm) 15 ml tube, conical bottom, with cap (17 x 120 mm), Falcon®; [15050] 15ml Sarstedt®(17 x 120 mm)
-----	---	--

14248

[6]	15055	30 ml probówka z pokrywką (25,4 x 103,2 mm) 30 ml tube with cap (25,4 x 103,2 mm)
-----	-------	--

14089+14868

[6]	*	5 ml probówka z korkiem wciskany (17 x 54,2 mm), Eppendorf® 5 ml tube with snap cap (17 x 54,2 mm), Eppendorf®
-----	---	---

[6]	*	5 ml probówka z korkiem zakręcany (17 x 66 mm), Eppendorf® 5 ml tube with screw cap (17 x 66 mm), Eppendorf®
-----	---	---

11760**RPM 14600 RCF 20257 Rmax 85 4 45**

bez pojemnika/without bucket R max 85 RCF 20257 x g

14084 Rmax 85 RCF 20257

[24]	15127	0,5 ml probówka PCR (7,8 x 31 mm) 0,5 ml PCR tube (7,8 x 31 mm)
------	-------	--

14126 Rmax 85 RCF 20257

[24]	15124	0,4 ml probówka PCR (5,7 x 48,6 mm) 0,4 ml PCR tube (5,7 x 48,6 mm)
------	-------	--

14133 Rmax 85 RCF 20257

[24]	15125	0,2 ml probówka PCR (6 x 21,6 mm) 0,2 ml PCR tube (6 x 21,6 mm)
------	-------	--

bez wkładki/without adapter Rmax 85 RCF 20257

[24]	*	2-1,5 ml probówka (10,8x41,8 mm), Eppendorf®; [15011], 2 ml (10,8x41,8 mm); [15128], 1,5ml (10,8x40,5 mm) 2-1,5 ml tube (10,8x41,8 mm), Eppendorf®; [15011], 2 ml (10,8x41,8 mm); [15128], 1,5ml (10,8x40,5 mm)
------	---	--

[24]	*	2 ml probówki z filtrem - spin columns (10,8 x 46 mm) 2 ml spin columns (with filter) (10,8 x 46 mm); [15011], 2 ml (10,8x41,8 mm); [15128], 1,5ml (10,8x40,5 mm)
------	---	--

11943**RPM 12000 RCF 13684 Rmax 85 4 45**

bez pojemnika/without bucket R max 85 RCF 13684 x g

bez wkładki/without adapter Rmax 85 RCF 13684

[20]	*	1,6 ml probówka Cryo (12,3 x 46,5 mm) 1,6 ml Cryo tube (12,3 x 46,5 mm)
------	---	--

[20]	*	1,8 ml probówka Cryo (12,3 x 46,5 mm) 1,8 ml Cryo tube (12,3 x 46,5 mm)
------	---	--

11944**RPM 12000 RCF 13684 Rmax 85 4 45**

bez pojemnika/without bucket R max 85 RCF 13684 x g

bez wkładki/without adapter Rmax 85 RCF 13684

[6]	*	5 ml probówka z korkiem zakręcany (17 x 66 mm), Eppendorf® 5 ml tube with screw cap (17 x 66 mm), Eppendorf®
-----	---	---

[12]	*	5 ml probówka z korkiem wciskany (17 x 54,2 mm), Eppendorf® 5 ml tube with snap cap (17 x 54,2 mm), Eppendorf®
------	---	---

12200**RPM 4000 RCF 2164 Rmax 121 4 90**

13113 R max 121 RCF 2164 x g

bez wkładki/without adapter Rmax 121 RCF 2164

[48]	*	BD Vacutainer® (13 x 75 mm), (1,6-5,3 ml)
------	---	---

[48]	*	Greiner Vacuette® (13 x 75 mm), (1-4,5 ml)
------	---	--

[48]	*	Sarstedt S-Monovette® (11 x 66 mm), (1,6; 2; 2,7; 3; 3,1 ml)
------	---	--

[48]	*	Sarstedt S-Monovette® (13 x 65 mm), (2,6; 2,9; 3,4; 3,8 ml)
------	---	---

A. Wyposażenie dodatkowe/Optional accessories**MPW-260/R/RH****12200****RPM 4000 RCF 2469 Rmax 138 α 90**

13215 R max 138 RCF 2469 x g

bez wkładki/without adapter Rmax 138 RCF 2469

[8]	*	BD Vacutainer® (16 x 100 mm), (2,5-11 ml)
[8]	*	Greiner Vacuette® (16 x 100 mm), (7-9 ml)
[8]	*	Sarstedt S-Monovette® (15 x 92 mm), (7,5; 8,2; 8,5 ml)
[8]	*	Sarstedt S-Monovette® (16 x 92 mm), (9; 10 ml)
[8]	15046	14 ml probówka z pokrywką (16,8 x 113,7 mm), Sarstedt® 14 ml tube with cap (16,8 x 113,7 mm), Sarstedt®
[8]	15048	15 ml Thermo Nalgene® (16 x 113 mm) 15 ml Thermo Nalgene® (16 x 113 mm)
[8]	15053	10 ml probówka z pokrywką (16 x 106 mm) 10 ml tube with cap (16 x 106 mm)
[8]	15118	10 ml probówka szklana (16 x 100 mm) 10 ml glass tube (16 x 100 mm)
[8]	*	15 ml probówka z dnem stożkowym z zakrętką (17 x 120 mm), Falcon®; [15050], 15ml (17 x 120 mm) 15 ml tube, conical bottom, with cap (17 x 120 mm), Falcon®; [15050] 15ml Sarstedt®(17 x 120 mm)
		14082 Rmax 138 RCF 2469
[8]	*	BD Vacutainer® (13 x 100 mm), (4-7 ml)
[8]	*	Greiner Vacuette® (13 x 100 mm), (3,5-6 ml)
[8]	*	Sarstedt S-Monovette® (11 x 92 mm), (4,5; 5 ml)
[8]	15054	6 ml probówka z pokrywką (11,5 x 92 mm), Sarstedt® 6 ml tube with cap (11,5 x 92 mm), Sarstedt®
[8]	15119	7 ml probówka szklana (12 x 100 mm) 7 ml glass tube (12 x 100 mm)

12200**RPM 4000 RCF 2504 Rmax 140 α 90**

13200

14013

[32]	*	BD Vacutainer® (13 x 100 mm), (4-7 ml)
[32]	*	Greiner Vacuette® (13 x 100 mm), (3,5-6 ml)
[32]	*	Sarstedt S-Monovette® (11 x 92 mm), (4,5; 5 ml)
[32]	*	BD Vacutainer® (13 x 75 mm), (1,6-5,3 ml)
[32]	*	Greiner Vacuette® (13 x 75 mm), (1-4,5 ml)
[32]	*	Sarstedt S-Monovette® (13 x 65 mm), (2,6; 2,9; 3,4; 3,8 ml)
[32]	*	Sarstedt S-Monovette® (13 x 75 mm), (2,7; 3; 4,3 ml)
[32]	*	Sarstedt S-Monovette® (13 x 90 mm), (4,9; 5,6 ml)
[32]	15054	6 ml probówka z pokrywką (11,5 x 92 mm), Sarstedt® 6 ml tube with cap (11,5 x 92 mm), Sarstedt®
[32]	15119	7 ml probówka szklana (12 x 100 mm) 7 ml glass tube (12 x 100 mm)
[32]	15120	5 ml probówka szklana (12 x 75 mm) 5 ml glass tube (12 x 75 mm)
[32]	15419	5 ml probówka z korkiem (12 x 85 mm), Sarstedt® 5 ml tube with cap (12 x 85 mm), Sarstedt®

14016

[28]	*	Sarstedt S-Monovette® (15 x 75 mm), (4; 4,3; 5,5 ml)
[28]	*	BD Vacutainer® (16 x 100 mm), (2,5-11 ml)
[28]	*	Greiner Vacuette® (16 x 100 mm), (7-9 ml)
[28]	*	Sarstedt S-Monovette® (15 x 92 mm), (7,5; 8,2; 8,5 ml)
[28]	*	10 ml Thermo Nalgene® Oak Ridge (16 x 81,5 mm)
[28]	15053	10 ml probówka z pokrywką (16 x 106 mm) 10 ml tube with cap (16 x 106 mm)
[28]	15118	10 ml probówka szklana (16 x 100 mm) 10 ml glass tube (16 x 100 mm)
[28]	15046	14 ml probówka z pokrywką (16,8 x 113,7 mm), Sarstedt® 14 ml tube with cap (16,8 x 113,7 mm), Sarstedt®

14020

[20]	*	Sarstedt S-Monovette® (15 x 75 mm), (4; 4,3; 5,5 ml)
[20]	*	10 ml Thermo Nalgene® Oak Ridge (16 x 81,5 mm)
[20]	*	BD Vacutainer® (16 x 100 mm), (2,5-11 ml)
[20]	*	Greiner Vacuette® (16 x 100 mm), (7-9 ml)
[20]	*	Sarstedt S-Monovette® (15 x 92 mm), (7,5; 8,2; 8,5 ml)
[20]	*	Sarstedt S-Monovette® (16 x 92 mm), (9; 10 ml)

* probówka niedostępna w ofercie MPW lub dostępny odpowiednik (np:[15050]), patrz kolumna z prawej
tube is not offered by MPW or equivalent is available (e.g. [15050]), see column on the right

A. Wyposażenie dodatkowe/Optional accessories

MPW-260/R/RH

[20]	15053	10 ml probówka z pokrywką (16 x 106 mm) 10 ml tube with cap (16 x 106 mm)
[20]	15118	10 ml probówka szklana (16 x 100 mm) 10 ml glass tube (16 x 100 mm)
[20]	*	13 ml probówka (Ø16x100mm), Sarstedt® nr 62.515.006 13 ml tube (Ø16 x 100 mm), Sarstedt® no. 62.515.006
[20]	15046	14 ml probówka z pokrywką (16,8 x 113,7 mm), Sarstedt® 14 ml tube with cap (16,8 x 113,7 mm), Sarstedt®
[20]	15121	10 ml probówka z dnem okrągłym i pokrywką (17 x 70 mm) 10 ml tube, round bottom, with cap (17 x 70 mm)
14021		
[40]	*	2-1,5 ml probówka (10,8x41,8 mm), Eppendorf®; [15011], 2 ml (10,8x41,8 mm); [15128], 1,5ml (10,8x40,5 mm) 2-1,5 ml tube (10,8x41,8 mm), Eppendorf®; [15011], 2 ml (10,8x41,8 mm); [15128], 1,5ml (10,8x40,5 mm)
[40]	*	2 ml probówki z filtrem - spin columns (10,8 x 46 mm) 2 ml spin columns (with filter) (10,8 x 46 mm); [15011], 2 ml (10,8x41,8 mm); [15128], 1,5ml (10,8x40,5 mm)
14023		
[4]	*	28 ml Thermo Nalgene® Oak Ridge (25,4 x 101,8 mm)
[4]	15056	30 ml Thermo Nalgene® Oak Ridge (25,5 x 94,3 mm) 30 ml Thermo Nalgene® Oak Ridge (25,5 x 94,3 mm)
[4]	15055	30 ml probówka z pokrywką (25,4 x 103,2 mm) 30 ml tube with cap (25,4 x 103,2 mm)
[4]	15222	30 ml probówka z pokrywką (25 x 94mm), Sterilin® 30 ml tube with cap (25 x 94 mm), Sterilin®
[4]	15223	30 ml probówka z pokrywką (25 x 94 mm), Sterilin® 30 ml tube with cap (25 x 94 mm), Sterilin®
[4]	15117	25 ml probówka szklana (25 x 100 mm) 25 ml glass tube (25 x 100 mm)
[4]	15424	30 ml probówka z pokrywką (25,5 x 94 mm), Nalgene® 30 ml tube with cap (25,5 x 94 mm), Nalgene®
14026		
[4]	*	50 ml probówka z dnem stożkowym z rantem (30 x 115 mm), Greiner® 50 ml tube, conical bottom, skirted (30 x 115 mm), Greiner®
14026+14188		
[4]	15051	50 ml Thermo Nalgene® Oak Ridge (28,8 x 106,7 mm) 50 ml Thermo Nalgene® Oak Ridge (28,8 x 106,7 mm)
[4]	*	50 ml probówka z dnem stożkowym z zakrętką (30 x 117 mm), Falcon®; [15052] 50ml (30 x 117mm) 50 ml tube, conical bottom, with cap (30 x 117 mm), Falcon®; [15052] 50ml Sarstedt® (30 x 117 mm)
[4]	*	50 ml probówka z dnem stożkowym bez rantu (30 x 115 mm), Greiner® 50 ml tube, conical bottom, without skirt (30 x 115 mm), Greiner®
[4]	*	50 ml probówka Advanced Oak Ridge (29x102 mm), Herolab® nr 25 32 11 50 ml tube, Advanced Oak Ridge (29 x 102 mm), Herolab® no. 25 32 11
14028		
[4]	15116	50 ml probówka szklana (35 x 100 mm) 50 ml glass tube (35 x 100 mm)
14029		
[48]	*	Sarstedt S-Monovette® (11 x 92 mm), (4,5; 5 ml)
[48]	*	Sarstedt S-Monovette® (11 x 66 mm), (1,6; 2; 2,7; 3; 3,1 ml)
[48]	15054	6 ml probówka z pokrywką (11,5 x 92 mm), Sarstedt® 6 ml tube with cap (11,5 x 92 mm), Sarstedt®
[48]	15119	7 ml probówka szklana (12 x 100 mm) 7 ml glass tube (12 x 100 mm)
[48]	15120	5 ml probówka szklana (12 x 75 mm) 5 ml glass tube (12 x 75 mm)
[48]	15419	5 ml probówka z korkiem (12 x 85 mm), Sarstedt® 5 ml tube with cap (12 x 85 mm), Sarstedt®
14100+14196		
[4]	15040	100 ml probówka z pokrywką (45,2 x 103,7 mm) 100 ml tube with cap (45,2 x 103,7 mm)
14100+14188		
[4]	15115	100 ml probówka szklana (44 x 100 mm) 100 ml glass tube (44 x 100 mm)
14027		
[4]	*	15 ml probówka z dnem stożkowym z zakrętką (17 x 120 mm), Falcon®; [15050], 15ml (17 x 120 mm) 15 ml tube, conical bottom, with cap (17 x 120 mm), Falcon®; [15050] 15ml Sarstedt® (17 x 120 mm)
13201+17202		
14013		
[32]	*	BD Vacutainer® (13 x 100 mm), (4-7 ml)
[32]	*	Greiner Vacuette® (13 x 100 mm), (3,5-6 ml)
[32]	*	Sarstedt S-Monovette® (11 x 92 mm), (4,5; 5 ml)
[32]	*	BD Vacutainer® (13 x 75 mm), (1,6-5,3 ml)

A. Wyposażenie dodatkowe/Optional accessories**MPW-260/R/RH**

[32]	*	Greiner Vacuette® (13 x 75 mm), (1-4,5 ml)
[32]	*	Sarstedt S-Monovette® (13 x 65 mm), (2,6; 2,9; 3,4; 3,8 ml)
[32]	*	Sarstedt S-Monovette® (13 x 75 mm), (2,7; 3; 4,3 ml)
[32]	*	Sarstedt S-Monovette® (13 x 90 mm), (4,9; 5,6 ml)
[32]	15054	6 ml probówka z pokrywką (11,5 x 92 mm), Sarstedt® 6 ml tube with cap (11,5 x 92 mm), Sarstedt®
[32]	15119	7 ml probówka szklana (12 x 100 mm) 7 ml glass tube (12 x 100 mm)
[32]	15120	5 ml probówka szklana (12 x 75 mm) 5 ml glass tube (12 x 75 mm)
[32]	15419	5 ml probówka z korkiem (12 x 85 mm), Sarstedt® 5 ml tube with cap (12 x 85 mm), Sarstedt®
14016		
[28]	*	Sarstedt S-Monovette® (15 x 75 mm), (4; 4,3; 5,5 ml)
[28]	*	BD Vacutainer® (16 x 100 mm), (2,5-11 ml)
[28]	*	Greiner Vacuette® (16 x 100 mm), (7-9 ml)
[28]	*	10 ml Thermo Nalgene® Oak Ridge (16 x 81,5 mm)
[28]	15053	10 ml probówka z pokrywką (16 x 106 mm) 10 ml tube with cap (16 x 106 mm)
[28]	15118	10 ml probówka szklana (16 x 100 mm) 10 ml glass tube (16 x 100 mm)
[28]	15046	14 ml probówka z pokrywką (16,8 x 113,7 mm), Sarstedt® 14 ml tube with cap (16,8 x 113,7 mm), Sarstedt®
14020		
[20]	*	Sarstedt S-Monovette® (15 x 75 mm), (4; 4,3; 5,5 ml)
[20]	*	10 ml Thermo Nalgene® Oak Ridge (16 x 81,5 mm)
[20]	*	BD Vacutainer® (16 x 100 mm), (2,5-11 ml)
[20]	*	Greiner Vacuette® (16 x 100 mm), (7-9 ml)
[20]	15053	10 ml probówka z pokrywką (16 x 106 mm) 10 ml tube with cap (16 x 106 mm)
[20]	15118	10 ml probówka szklana (16 x 100 mm) 10 ml glass tube (16 x 100 mm)
[20]	*	13 ml probówka (Ø16x100mm), Sarstedt® nr 62.515.006 13 ml tube (Ø16 x 100 mm), Sarstedt® no. 62.515.006
[20]	15046	14 ml probówka z pokrywką (16,8 x 113,7 mm), Sarstedt® 14 ml tube with cap (16,8 x 113,7 mm), Sarstedt®
[20]	15121	10 ml probówka z dnem okrągłym i pokrywką (17 x 70 mm) 10 ml tube, round bottom, with cap (17 x 70 mm)
14021		
[40]	*	2-1,5 ml probówka (10,8x41,8 mm), Eppendorf®; [15011], 2 ml (10,8x41,8 mm); [15128], 1,5ml (10,8x40,5 mm) 2-1,5 ml tube (10,8x41,8 mm), Eppendorf®; [15011], 2 ml (10,8x41,8 mm); [15128], 1,5ml (10,8x40,5 mm)
[40]	*	2 ml probówki z filtrem - spin columns (10,8 x 46 mm) 2 ml spin columns (with filter) (10,8 x 46 mm); [15011], 2 ml (10,8x41,8 mm); [15128], 1,5ml (10,8x40,5 mm)
14023		
[4]	*	28 ml Thermo Nalgene® Oak Ridge (25,4 x 101,8 mm)
[4]	15056	30 ml Thermo Nalgene® Oak Ridge (25,5 x 94,3 mm) 30 ml Thermo Nalgene® Oak Ridge (25,5 x 94,3 mm)
[4]	15055	30 ml probówka z pokrywką (25,4 x 103,2 mm) 30 ml tube with cap (25,4 x 103,2 mm)
[4]	15222	30 ml probówka z pokrywką (25 x 94mm), Sterilin® 30 ml tube with cap (25 x 94 mm), Sterilin®
[4]	15223	30 ml probówka z pokrywką (25 x 94 mm), Sterilin® 30 ml tube with cap (25 x 94 mm), Sterilin®
[4]	15117	25 ml probówka szklana (25 x 100 mm) 25 ml glass tube (25 x 100 mm)
[4]	15424	30 ml probówka z pokrywką (25,5 x 94 mm), Nalgene® 30 ml tube with cap (25,5 x 94 mm), Nalgene®
14026+14188		
[4]	15051	50 ml Thermo Nalgene® Oak Ridge (28,8 x 106,7 mm) 50 ml Thermo Nalgene® Oak Ridge (28,8 x 106,7 mm)
14028		
[4]	15116	50 ml probówka szklana (35 x 100 mm) 50 ml glass tube (35 x 100 mm)
14029		
[48]	*	Sarstedt S-Monovette® (11 x 66 mm), (1,6; 2; 2,7; 3; 3,1 ml)
[48]	15054	6 ml probówka z pokrywką (11,5 x 92 mm), Sarstedt® 6 ml tube with cap (11,5 x 92 mm), Sarstedt®
[48]	15119	7 ml probówka szklana (12 x 100 mm) 7 ml glass tube (12 x 100 mm)
[48]	15120	5 ml probówka szklana (12 x 75 mm) 5 ml glass tube (12 x 75 mm)

A. Wyposażenie dodatkowe/Optional accessories**MPW-260/R/RH**

[48]	15419	5 ml probówka z korkiem (12 x 85 mm), Sarstedt® 5 ml tube with cap (12 x 85 mm), Sarstedt® 14100+14196
[4]	15040	100 ml probówka z pokrywką (45,2 x 103,7 mm) 100 ml tube with cap (45,2 x 103,7 mm) 14100+14188
[4]	15115	100 ml probówka szklana (44 x 100 mm) 100 ml glass tube (44 x 100 mm) 13201+17203 14021
[40]	*	2-1,5 ml probówka (10,8x41,8 mm), Eppendorf®; [15011], 2 ml (10,8x41,8 mm); [15128], 1,5ml (10,8x40,5 mm) 2-1,5 ml tube (10,8x41,8 mm), Eppendorf®; [15011], 2 ml (10,8x41,8 mm); [15128], 1,5ml (10,8x40,5 mm)
[40]	*	2 ml probówki z filtrem - spin columns (10,8 x 46 mm) 2 ml spin columns (with filter) (10,8 x 46 mm); [15011], 2 ml (10,8x41,8 mm); [15128], 1,5ml (10,8x40,5 mm) 14026
[4]	*	50 ml probówka z dnem stożkowym z rantem (30 x 115 mm), Greiner® 50 ml tube, conical bottom, skirted (30 x 115 mm), Greiner® 14026+14188
[4]	15051	50 ml Thermo Nalgene® Oak Ridge (28,8 x 106,7 mm) 50 ml Thermo Nalgene® Oak Ridge (28,8 x 106,7 mm)
[4]	*	50 ml probówka z dnem stożkowym z zakrętką (30 x 117 mm), Falcon®; [15052] 50ml (30 x 117mm) 50 ml tube, conical bottom, with cap (30 x 117 mm), Falcon®; [15052] 50ml Sarstedt® (30 x 117 mm)
[4]	*	50 ml probówka z dnem stożkowym bez rantu (30 x 115 mm), Greiner® 50 ml tube, conical bottom, without skirt (30 x 115 mm), Greiner®
[4]	*	50 ml probówka Advanced Oak Ridge (29x102 mm), Herolab® nr 25 32 11 50 ml tube, Advanced Oak Ridge (29 x 102 mm), Herolab® no. 25 32 11 14028
[4]	15116	50 ml probówka szklana (35 x 100 mm) 50 ml glass tube (35 x 100 mm) 14100+14196
[4]	15040	100 ml probówka z pokrywką (45,2 x 103,7 mm) 100 ml tube with cap (45,2 x 103,7 mm) 14100+14188
[4]	15115	100 ml probówka szklana (44 x 100 mm) 100 ml glass tube (44 x 100 mm) 14027
[4]	*	15 ml probówka z dnem stożkowym z zakrętką (17 x 120 mm), Falcon®; [15050], 15ml (17 x 120 mm) 15 ml tube, conical bottom, with cap (17 x 120 mm), Falcon®; [15050] 15ml Sarstedt®(17 x 120 mm)

12218**RPM 3000 RCF 916 Rmax 91 \neq 90**

13219

bez wkładki/without adapter

[2]	15102	płytkę titracyjną MTP 28,8ml (86x128x15/17,5 mm) microtiter plate MTP 28,8 ml (86 x 128 x 15/17,5 mm)
-----	-------	--

12300**RPM 13000 RCF 16816 Rmax 89 \neq 90**

bez pojemnika/without bucket

bez wkładki/without adapter

[24]	15100	37 μ l kapilara hematokrytowa (1,4 x 75 mm) 37 μ l micro-hematocrit capillary tube (1,4 x 75 mm)
------	-------	---

Suma końcowa

EU DECLARATION OF CONFORMITY

This EU declaration of conformity is issued under the sole responsibility of the manufacturer.

Manufacturer: **"MPW MED. INSTRUMENTS" SPÓŁDZIELNIA PRACY**
46 Boremłowska Street, 04-347 Warsaw, Poland

We apply the certified
Quality Management System
in accordance
with the standards: PN-EN ISO 9001:2015, PN-EN ISO 13485:2016

Product name: **Laboratory centrifuge MPW-260**

The aforementioned product is in conformity with the following EU regulations and directives:

- **2017/746 (IVDR)** REGULATION (EU) 2017/746 OF THE EUROPEAN PARLIAMENT AND OF THE COUNCIL of 5 April 2017 on in vitro diagnostic medical devices and repealing Directive 98/79/EC and Commission Decision 2010/227/EU
- **2011/65/UE (RoHS 2)** DIRECTIVE 2011/65/EU OF THE EUROPEAN PARLIAMENT AND OF THE COUNCIL of 8 June 2011 on the restriction of the use of certain hazardous substances in electrical and electronic equipment

Intended purpose: The product is a benchtop laboratory centrifuge specifically intended by the manufacturer for in vitro diagnostic (IVD) procedures. It is used for the separation of mixtures, suspensions, body fluids into components of different density under the influence of centrifugal force.

Risk class: **Class A (in accordance with Annex VIII, rule 5)**

The assessment of the conformity of the device has been carried out in accordance with Article 48(10) of Regulation (EU) 2017/746.

Wojciech Anisiewicz
Vice-President of the Management Board

Łukasz Sałański
President of the Management Board

EU DECLARATION OF CONFORMITY

This EU declaration of conformity is issued under the sole responsibility of the manufacturer.

Manufacturer: **"MPW MED. INSTRUMENTS" SPÓŁDZIELNIA PRACY**
46 Boremlowska Street, 04-347 Warsaw, Poland

We apply the certified
Quality Management System
in accordance
with the standards: PN-EN ISO 9001:2015, PN-EN ISO 13485:2016

Product name: **Refrigerated laboratory centrifuge MPW-260R**

The aforementioned product is in conformity with the following EU regulations and directives:

- **2017/746 (IVDR)** REGULATION (EU) 2017/746 OF THE EUROPEAN PARLIAMENT AND OF THE COUNCIL of 5 April 2017 on in vitro diagnostic medical devices and repealing Directive 98/79/EC and Commission Decision 2010/227/EU
- **2011/65/UE (RoHS 2)** DIRECTIVE 2011/65/EU OF THE EUROPEAN PARLIAMENT AND OF THE COUNCIL of 8 June 2011 on the restriction of the use of certain hazardous substances in electrical and electronic equipment

Intended purpose: The product is a benchtop laboratory centrifuge specifically intended by the manufacturer for in vitro diagnostic (IVD) procedures. It is used for the separation of mixtures, suspensions, body fluids into components of different density under the influence of centrifugal force.

Risk class: **Class A (in accordance with Annex VIII, rule 5)**

The assessment of the conformity of the device has been carried out in accordance with Article 48(10) of Regulation (EU) 2017/746.

Wojciech Anisiewicz
Vice-President of the Management Board

Łukasz Sałański
President of the Management Board

DECLARATION OF DECONTAMINATION

(repair)

In order to protect our employees please fill out the declaration of decontamination completely before sending centrifuge to the manufacturer (repair).

1. Device:

– type:

– serial No.:

2. Description of decontamination

(see user manual)

.....

.....

.....

.....

3. Decontamination carried out by:

name:

4. Date and signature:

.....

DECLARATION OF DECONTAMINATION

(return)

In order to protect our employees please fill out the declaration of decontamination completely before sending centrifuge to the manufacturer (return).

1. Device:

– type:

– serial No.:

2. Description of decontamination

(see user manual)

.....
.....
.....
.....

3. Decontamination carried out by:

name:

4. Date and signature:

.....

NOMOGRAM

Centrifuging radius [cm]

R.C.F. (x "g")
multiple of
gravitational
acceleration

[r.p.m.]

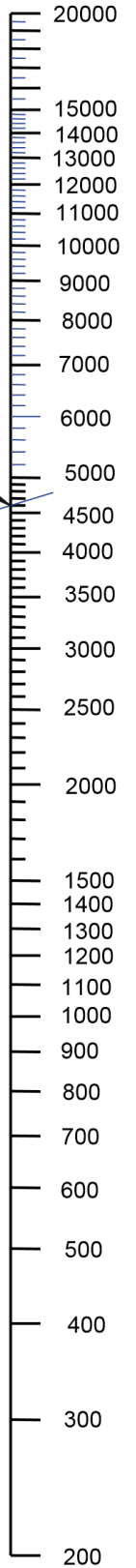
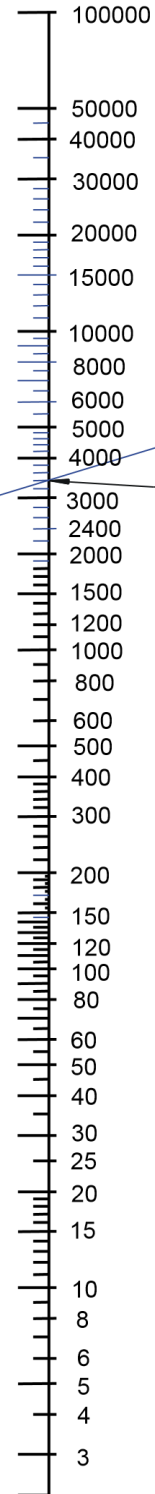
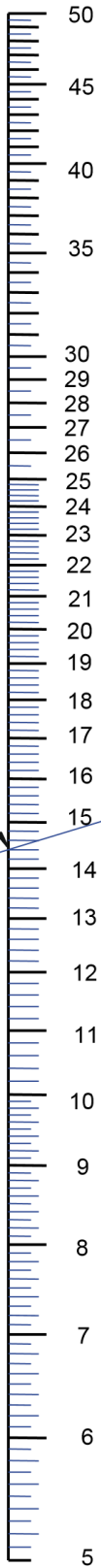

Formula used for calculation of this nomogram :

$$R.C.F. = 11,18 * r * (n/1000)^2$$

where :

- R.C.F. - multiple of gravitational acceleration
- r - centrifuging radius (cm)
- n - rotational speed (r.p.m.)
- g - gravitational acceleration

Example of making use
of the nomogram:

A=14,4 cm
B=4600 r.p.m.
C=3400 x g

$$n = 1000 * \sqrt{\frac{RCF}{(11,18 * r)}}$$

$$r = \frac{RCF}{\left[11,18 * \left(\frac{n}{1000} \right)^2 \right]}$$

A

B

C