

USER MANUAL



Laboratory centrifuge MPW M-UNIVERSAL
Laboratory centrifuge MPW M-DIAGNOSTIC
Laboratory centrifuge MPW M-SCIENCE

Read before use!

Serial number of the centrifuge:

For centrifuges with serial no (SN):
MPW M-UNIVERSAL: from 102MU051222
MPW M-DIAGNOSTIC: from 102MD111622
MPW M-SCIENCE: from 102MS024622



This manual was prepared with special care. MPW MED. INSTRUMENTS may change the manual at any time and without notice because of improvements, typographical errors, or improvements to facilities

All rights reserved. No part of this User Manual may be modified, distributed, published, or reproduced without the prior permission of MPW MED. INSTRUMENTS.

You can find the current version of the user manual on our website under:









www.mpw.pl DOWNLOAD section (one should choose demanded language version of website).

Content

1	Symbols used in the manual and on the device.....	5
2	Application.....	5
3	Technical specification	6
3.1	Environmental conditions.....	6
4	Installation.....	7
4.1	Content of the package.....	7
4.2	Location.....	7
4.3	Current protection	8
5	Safety notes	8
5.1	General remarks	8
5.2	Filling the rotor	8
5.2.1	Angular rotors.....	8
5.2.2	Horizontal rotors.....	8
5.2.3	Filling tubes.....	9
5.3	Safety hints	10
5.4	Operating conditions	10
5.5	Equipment life.....	11
5.6	Work safety.....	11
5.7	Unbalance	12
5.8	Residual risk.....	12
6	Operating.....	12
6.1	Centrifuge description	12
6.2	Centrifuge overview.....	13
6.3	Construction.....	13
6.4	Name plate.....	14
6.5	Rotor and accessories installation	14
6.6	Control device.....	15
6.7	Setting parameters	15
6.8	Safety features	15
6.9	Increase in temperature	15
7	Centrifuging	16
7.1	Control panel	16
7.2	Display.....	16
7.2.1	Setting up RPM, RCF, TIME, temperature on the SIMPLIFIED DISPLAY.....	17
7.2.2	Switching between the screens.....	18
7.2.3	Setting up RPM, RCF, TIME, temperature on the NORMAL DISPLAY	18
7.3	Users programs.....	19
7.3.1	Program selection (Simplified display).....	19
7.3.2	Program selection (Basic display)	20
7.4	Creator of acceleration and deceleration curves.....	21
7.4.1	Acceleration characteristic, creation of episode 1	21
7.4.2	Adding and editing sections - acceleration.....	22
7.4.3	Acceleration graph.....	22
7.4.4	Deceleration characteristic, creation of episode 1	23
7.4.5	Adding and editing sections - deceleration.....	23
7.4.6	Deceleration graph	24
7.4.7	Deleting sections.....	24
7.5	Programs with user characteristics.....	24
7.6	Choosing rotors and container	25
7.6.1	Choosing rotors and container on the SIMPLIFIED SCREEN	25
7.6.2	Choosing rotors and container on the BASIC DISPLAY	25
7.7	SHORT mode.....	25
7.8	Terminating centrifugation	25
8	Parameters of centrifugation	26

8.1	Choosing parameters on the SIMPLIFIED SCREEN	26
8.2	Choosing parameters on the BASIC DISPLAY	26
8.3	Choosing centrifugation parameters	26
8.3.1	<i>Accelerating/decelerating – changing characteristics</i>	26
8.3.2	<i>Radius</i>	27
8.3.3	<i>Density</i>	27
8.3.4	<i>Automatic lid open</i>	27
8.3.5	<i>STARTY DELAY-OF TIME</i>	28
8.3.6	<i>Screen messages</i>	28
9	Screen menu	29
9.1	Starting MENU on the SIMPLIFIED DISPLAY	29
9.2	Starting MENU on the NORMAL DISPLAY.....	30
9.3	MENU navigation	30
9.4	Configuration.....	30
9.4.1	<i>Screen saver</i>	30
9.4.2	<i>Visual alarm</i>	30
9.4.3	<i>Counting time</i>	31
9.4.4	<i>Buzzer</i>	31
9.4.5	<i>Date/time</i>	31
9.4.6	<i>Language</i>	31
9.4.7	<i>Rotor automatic identification</i>	32
9.4.8	<i>Service inspection</i>	32
9.5	Password	32
9.6	10 cycles	34
9.7	Work time	34
9.8	Rotor cycles	34
9.9	Manufacturer’s details	34
9.10	Diagnostics	34
9.11	Factory settings	35
10	Report printout – USB (M-UNIVERSAL only)	35
11	Maintenance	37
11.1	Cleaning of the centrifuge	37
11.2	Maintenance of centrifuge elements	37
11.3	Sterilization	38
11.4	Autoclaving.....	39
11.5	Chemical resistance.....	40
12	Troubleshooting	41
12.1	Emergency cover release	41
13	Guarantee	42
14	Transport and storage	42
15	Disposal.....	43
16	Manufacturer’s info	43
	Distributor’s info.....	43
17	Annexes	43
A.	Additional accessories	
B.	Declaration of conformity (CE, ROHS 2)	
C.	Declaration of decontamination (repair / return)	
D.	Nomogram RPM / RCF	

1 Symbols used in the manual and on the device

Symbol	Explanation
	WARNING! Warning of potential injury or health risk
	DANGER! Risk of electric shock with potential for severe injury or death as a consequence
	DANGER! Biohazard with potential for risk to health or death as a consequence
	DANGER! Risk of explosion with potential for severe injury or death as a consequence
	Symbol identifying a medical device for in vitro diagnostic use
	CE mark
	Symbol informing about the method of disposal
	Please read the instruction manual before you start working with the device
	Manufacturer's data

The terms "**accessories**", "**optional accessories**" and "**equipment**" used in this manual mean the components of the centrifuge, such as: rotors, containers and reducing inserts.

2 Application

- MPW **M-UNIVERSAL**, **MPW M-DIAGNOSTIC**, **MPW M-SCIENCE** centrifuges are a family of ventilated, non-automatic table-top laboratory centrifuges.
- The device is intended for In Vitro Diagnostics (IVD). This means that it is an in vitro diagnostic medical device - in accordance with the Regulation of the European Parliament and of the Council (EU) of 5 April 2017 on in vitro diagnostic medical devices and repealing Directive 98/79/EC and Commission Decision 2010 /227/EU.
- The centrifuge is used to separate aqueous solutions and suspensions of samples with a density not higher than 1.2g/cm³ taken from human, animal and plant organisms into components of different densities under the influence of centrifugal force, in order to provide information about their biological state and to other analytical work.

- The design of the centrifuge ensures ease of use, safe operation and a wide range of applications in medical, biochemical and other analysis laboratories.
- The centrifuge is not biotight, therefore, when centrifuging preparations that require biotightness, containers and rotors with a biotightness certificate should be used.

3 Technical specification

manufacturer	"MPW MED. INSTRUMENTS" SPÓŁDZIELNIA PRACY, Boremłowska 46 Street, 04-347 Warszawa														
type	MPW M-DIAGNOSTIC					MPW M-SCIENCE					MPW M-UNIVERSAL				
mains voltage (L1+N+PE)	230V	100V	110V	120V	127V	230V	100V	110V	120V	127V	230V	100V	110V	120V	127V
	±10%		±5%			±10%		±5%			±10%		±5%		
mains frequency	50Hz		60Hz			50Hz		60Hz			50Hz		60Hz		
connected load (max.)	190W					220W									
current protection [A]	T 8A														
capacity (max.)	500 ml					100ml					500ml				
speed – RPM	90 ÷ 6000 rpm (step 1 rpm)					90 ÷ 18000 rpm (step 1 rpm)									
force – RCF	4830 x g (step 1 x g)					24270 x g (step 1 x g)									
running time	00:00:01 ÷ 99:59:59 – [h. : min : s] (1s step)														
time counting	since start button is pressed / since preselected speed is reached														
short-time operation mode – SHORT	yes														
continuous operation mode – HOLD	yes														
menu languages	Polish, English, German, Spanish, Italian, Portuguese, Russian, Swedish, French, Czech														
user programs	100														
acceleration (ACEL)	10 linear curves														
deceleration (DECEL)	10 linear curves														
USB communication	no					no					yes				
Electromagnetic compatibility	according to EN 61326-1:2006														
degree of protection	IP20														
dimensions:															
height (H)	299 mm														
width (W)	357 mm														
depth (D)	451 mm														
height with open cover (H _{oc})	572 mm														
noise level	≤60dB														
weight 230V	approx. 22 kg					approx. 20 kg					approx. 22 kg				
weight 120V	approx. 23,7 kg					approx. 21,5 kg					approx. 24,2 kg				

3.1 Environmental conditions

- The device may only be used indoors.
- The permissible ambient temperature is 2°C to 40°C.
- Maximum allowed relative humidity 80% at temperature up to 31°C decreasing linearly to 50% relative humidity at 40°C.
- The mains voltage fluctuations must not exceed ± 10% of the nominal voltage.
- Maximum altitude 2,000 m above sea level.
- Overvoltage category II.
- Pollution degree 2.

4 Installation

Open the package. Remove the box containing the accessories. Take out centrifuge from the container. Keep the box and packing materials in case of service shipping.

4.1 Content of the package

name	pcs.	cat no.
centrifuge MPW M-UNIVERSAL/MPW M-DIAGNOSTIC / MPW M-SCIENCE /	1	102MU/2-56 102MU/1-56 102MD/2-56 102MD/1-56 102MS/2-56 102MS/1-56 (Type and supply version dependent)
complete clamp	1	17142
spanner for the rotor	1	17099T
spanner for emergency opening of the cover	1	18640
power cord 230V / 120V	1	17866/17867
fuse WTA T8A 1150V	2	17865
vaseline 20ml	1	17201
USB A-A cable	1	16655*
user manual	1	See page 1

*- only MPW M-UNIVERSAL

4.2 Location

	<ul style="list-style-type: none"> ▪ The device is heavy, so lifting and carrying the centrifuge can lead to back injuries. Risk of injury while lifting and carrying heavy loads. ▪ Lifting and transporting of the centrifuge should be done with a sufficient number of helpers. Use a transport aid for transporting the centrifuge. ▪ The device should be lifted by the underside in the vicinity of the its feet and placed directly on a suitable lab table. ▪ Ensure safe location. ▪ The centrifuge shall not be located near source of heat and shall not be subjected to direct sunlight. ▪ The table for the centrifuge shall be stable and shall have flat-levelled table top. ▪ Centrifuge should be set horizontally on a rigid base. ▪ It is necessary to ensure a safety zone of the minimum 30cm round the centrifuge from every direction (for ventilation needs). Do not veil ventilation holes ! ▪ Passed parameters of the centrifuge are referring to the above named temperatures (see 2.Technical specification). ▪ At the change of the place from cold to warm one, condensation of water will occur inside the centrifuge. It is important then that sufficient time be provided for drying the centrifuge prior to starting the centrifuge again (min. 4 hours).
	<ul style="list-style-type: none"> ▪ Do not position the centrifuge so that it is difficult to operate the power switch ▪ Supply voltage given on the rating plate has to be consistent with local supply voltage. MPW MED INSTRUMENTS laboratory centrifuges are 1st safety class devices and they are provided with the three-core cable with the plug resistant to dynamic loadings. Mains socket shall be provided with the safety pin - protective earth (PE). ▪ It is recommended to install emergency cut-out that shall be located far from the centrifuge, near the exit or beyond the room.



- Before switching on, check whether the centrifuge is connected to power supply correctly. It is obligatory to use only power cord recommended by manufacturer.
- Before using the device, check that it is properly installed.

4.3 Current protection



The centrifuge is equipped with thermal current protection. Fuse is situated in the plug-in socket unit at back wall of the centrifuge.

5 Safety notes

5.1 General remarks



- The laboratory centrifuge may be operated only by qualified laboratory personnel after getting acquainted with the user's manual.
- **The operating instructions are part of the product.**
- **The instruction manual should always be kept near the centrifuge.**
- The centrifuge cannot be operated inconsistently with its purpose.
- **If the centrifuge is used in a manner inconsistent with the manufacturer's guidelines, the safety of the device operation may be impaired.**

5.2 Filling the rotor

5.2.1 Angular rotors



- **Check that the rotor is properly seated and bolted to the motor axis.**
- Do not exceed the maximum rotor load (information is provided on the rotors).
- In order to ensure symmetrical loading, fill opposite openings of the rotor with inserts and test tubes of the same type and weight.

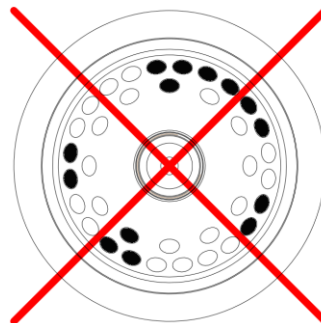
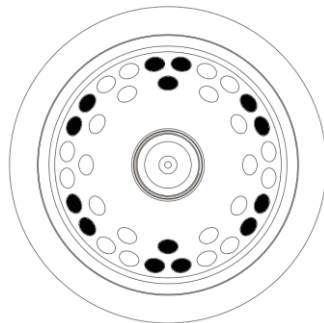

5.2.2 Horizontal rotors

- **Check that the rotor is properly seated and bolted to the motor axis.**
- **Do not exceed the maximum rotor load.**
- To ensure symmetrical and even rotor load, fill opposite slots with containers / hangers of the same type and weight.
- **Horizontal rotors must be filled with a complete set of containers / hangers.**
- Place test tubes symmetrically facing each other.
- Before starting centrifugation, check that all containers / hangers are properly hung and can

swing freely.

Place empty test tubes in containers. Manually tilt the containers to the horizontal position, check that there are no collisions between the test tubes, containers / hangers and the rotor.

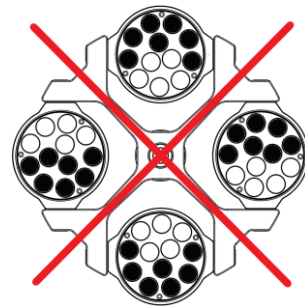
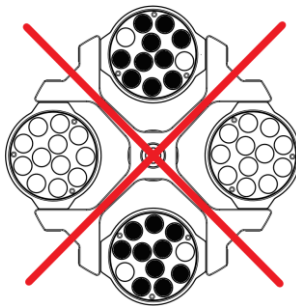
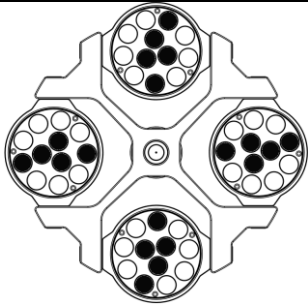

5.2.3 Filling tubes

- **Tubes may only be filled outside the centrifuge.**
- Tubes may only be filled with the maximum amount of substance specified by the manufacturer.
- The test tubes must be filled in such a way that the centrifuged substance does not run out of the vessel during centrifugation.

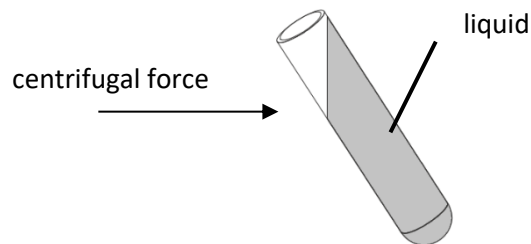

- In case the tube manufacturer has not specified a maximum level, fill the tubes according to the formula:

$$\text{Max liquid level} < \text{Tube height} - \frac{\text{Internal tube diameter}}{2}$$



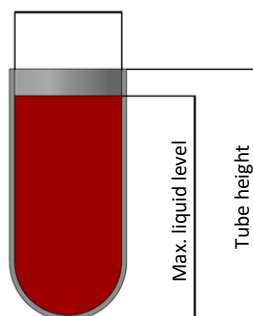

Internal tube diameter





- For centrifugation in the centrifuge, only containers included in the list of equipment and centrifuge tubes, the diameter, length and strength of which are appropriate, should be used. The use of test tubes from other manufacturers should be agreed with MPW MED. INSTRUMENTS or its authorized representatives.
- Pay attention to the quality and appropriate thickness of the walls of glass test tubes. **Glass tubes should be centrifuge tubes.**
- To prevent the centrifuge from being unbalanced, it is recommended to weigh the







	filled test tubes before inserting them into the rotor. When centrifuging in horizontal rotors, it is recommended to weigh the filled containers / hangers. This will allow to minimize the differences in mass between them, which will positively affect the suspension of the engine and the reduction of noise level during the operation of the centrifuge.
--	--

5.3 Safety hints

	<p>ROTORS MAINTENANCE</p> <ul style="list-style-type: none"> ▪ Lubricate the swing-out rotor journal pins. ▪ Use only accessories in good condition. ▪ Protect equipment against corrosion using accurate preventive maintenance.
	<p>HS ACCESSORIES MAINTENANCE</p> <ul style="list-style-type: none"> ▪ Make sure that rubber O-rings are lightly coated with silicone grease. Use high vacuum grease, e.g. type „C” by LUBRINA.
	<p>HAZARDOUS MATERIALS</p> <ul style="list-style-type: none"> ▪ MPW accessories are not biotight. For centrifuging infectious materials it is necessary to use hermetically closed tubes meeting demands of biotightness, in order to prevent germs migration into the centrifuge and beyond it. ▪ It is not allowed to subject to centrifugation toxic materials with damaged leak proof seals of the rotor or test-tube. Proper disinfection procedures have to be carried out when dangerous substances contaminated the centrifuge or its accessories.
	<p>EXPLOSIVE AND COMBUSTIBLE MATERIALS</p> <ul style="list-style-type: none"> ▪ It is not allowed to centrifuge explosive and inflammable materials. ▪ It is not allowed to centrifuge substances prone to reacting in result of supplying high energy during centrifugation. ▪ The centrifuge cannot be operated in explosion-endangered areas. ▪ It is not allowed to centrifuge materials capable of generating inflammable or explosive mixtures when subjected to air.

5.4 Operating conditions

	<p>START-UP</p> <ul style="list-style-type: none"> ▪ Prior to switching the centrifuge on, one shall read carefully all sections of this instruction in order to ensure smooth operation and avoid damages of this device or its accessories. ▪ In order to protect the centrifuge against unbalance, fill in the test tubes up to the same weight.
	<p>TRANSPORTATION</p> <ul style="list-style-type: none"> ▪ Centrifuge must not be transported with the rotor mounted on the shaft.
	<p>GENERAL HINTS</p> <ul style="list-style-type: none"> ▪ One must use original rotors, test-tubes and spare parts only. ▪ In case of faulty operation of the centrifuge one shall ask for assistance of service of MPW MED. INSTRUMENTS company or its authorized representatives. ▪ It is not allowed to switch the centrifuge on if it is not installed properly or rotor is not fitted correctly.

<p>CENTRIFUGES SUBSTANCES</p> <ul style="list-style-type: none"> It isn't allowed to exceed load limit set by the manufacturer. Rotors are intended for fluids of average homogeneous density equal to 1,2 g/cm³ or smaller when centrifugation is carried out at maximum speed. When fluids of higher density shall be used, then it is necessary to change density of centrifuges sample in PARAM/DENSITY field. Observe the limitation on the permissible mass specified on the rotor/ bucket (eg MAX 15g). If the designation is given on the rotor, it refers to the mass of the sample. If the designation is given on the bucket, it refers to the mass of the entire load, i.e. adapter+ tube + sample. <p>Examples:</p>			
	<table border="1" style="width: 100%;"> <tr> <td style="text-align: center;"> <p>Rotor</p>  <p>2,4g – maximal mass of tube content</p> </td> <td style="text-align: center;"> <p>Bucket</p>  <p>290g – maximal mass of elements inside bucket</p> </td> </tr> </table>	<p>Rotor</p>  <p>2,4g – maximal mass of tube content</p>	<p>Bucket</p>  <p>290g – maximal mass of elements inside bucket</p>
<p>Rotor</p>  <p>2,4g – maximal mass of tube content</p>	<p>Bucket</p>  <p>290g – maximal mass of elements inside bucket</p>		

5.5 Equipment life

	<ul style="list-style-type: none"> Each spin cycle during which the rotor has accelerated and decelerated is considered a duty cycle, regardless of the speed and its duration. Do not use the equipment after the allowable number of cycles or when the maximum service life has passed, whichever comes first.
--	---

5.6 Work safety

	<p>INSPECTION PROCEDURES CARRIED OUT BY THE OPERATOR</p> <p>Operator has to pay special attention to the fact that the centrifuge parts of key importance due to safety reasons are not damaged. This remark is specifically important as for:</p> <ul style="list-style-type: none"> Centrifuge accessories and especially structural changes, corrosion, preliminary cracks, abrasion of metal parts. Screw connections. Inspection of seals of the buckets if such are used. Special attention must be paid to all of the rubber (seals) parts. In the case of damage or visible structural changes defective parts must be replaced for new immediately. Control of execution of the guarantee yearly technical inspection of the centrifuge (after lapse of guarantee). Only the manufacturer-specified buckets, included in the equipment list, as well as centrifuge tubes, which diameter, length and durability are suitable, should be used for spinning in this centrifuge. The use of equipment made by other manufacturers should be consulted with the manufacturer of the centrifuge. It is not allowed to lift or shift the centrifuge during operation, and rest on it. It is not allowed to stay in the safety zone within 30 cm distance around the centrifuge neither leave within this zone some things, e.g., glass vessels. It is not allowed to put any objects on the centrifuge.
---	---

	<p>COVER OPENING</p> <ul style="list-style-type: none"> It is not allowed to open the cover manually in emergency procedure when rotor is still turning.
---	--

	<p>ROTORS</p> <ul style="list-style-type: none"> It is not allowed to use the rotors, buckets and round carriers with signs of corrosion or other mechanical damage. It is not allowed to centrifuge substances of high corrosive aggressiveness, which may damage the materials and reduce the mechanical properties of rotors, buckets and round carriers. It is not allowed to centrifuge rotors with removed or loose covers.
---	---

5.7 Unbalance

The centrifuge is provided with the rotor unbalance sensor and when it will be activated, centrifugation process will be stopped through fast braking and at the same time an error message will be displayed. Cancellation of this error is possible only through pressing **BACK, STOP, COVER, SET** or **▲▼◀▶**, key after stopping of the rotor.

One must check if rotor was correctly loaded, close the cover, and once more start the program. In order to protect the rotor against beating in opposite areas of the rotor, it has to be provided with identically filled buckets, carriers, test-tubes etc. for getting the best balance possible.

During loading rotors of M-SCIENCE centrifuge, special care must be taken, **unbalance must not exceed 3 g.**

	<p>Unbalance causes noise and vibrations during operation, and adversely affects power transmission system (motor, shock absorbers). The better balance, the smoother will be the centrifuge operation and therefore longer life of usage of the driveline. Moreover, the ideal separation level is then obtained, as already separated constituents would not be moved up by vibration.</p>
---	--

5.8 Residual risk

The centrifuge is built according to the state-of-the-art and the recognized safety regulations. Nevertheless, still remain some level of residual risk due to improper operation and malfunctions. It is possible to decrease residual risk by strictly applying user manual conditions and correcting malfunction which could threaten safety, immediately.

6 Operating

6.1 Centrifuge description

New generation of MPW MED. INSTRUMENTS laboratory centrifuges is provided with state-of-the-art microprocessor control systems, very durable and quiet asynchronous brushless motors, and accessories consistent with requirements of the present-day user.

6.2 Centrifuge overview



Rys.2. Right side of centrifuge

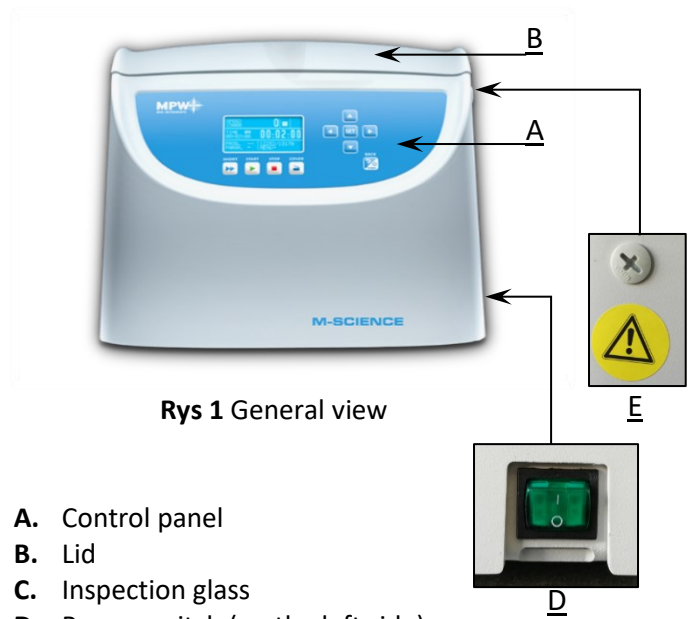

Rys 1 General view

- A. Control panel
- B. Lid
- C. Inspection glass
- D. Power switch (on the left side)
- E. Power switch Point of emergency lid opening (on the left side at the top)

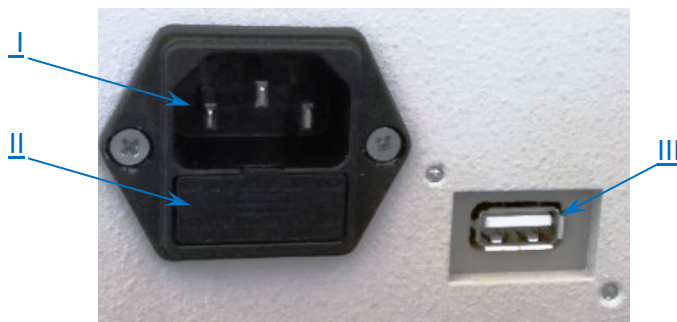

Rys.4. Back of the centrifuge

- I. Main socket
- II. Fuse socket
- III. USB [M-UNIVERSAL only]

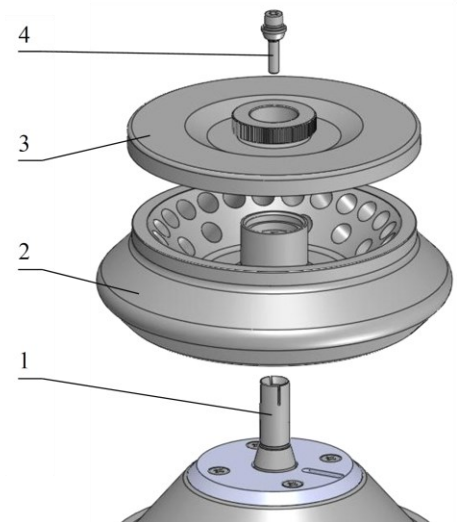

- 1. Motor axle
- 2. Rotor
- 3. Rotor lid
- 4. Complete clamp

6.3 Construction

The centrifuge has rigid self-supporting structure. Front and lid were made of ABS type plastic. Lid is fixed on steel axles of hinges and from the front it is locked with two electromagnetic locks blocking possible opening during centrifugation. Rotation chamber casing was made of thick steel sheet. The rotation chamber bowl is made of stainless-steel sheet.

6.4 Name plate

The data concerning the device should be read from the rating plate located on the rear wall of the centrifuge (the picture below is an example).

1	Centrifuge model	8	Manufacturer's information
2	Catalog number	9	Rated frequency
3	Maximum speed	10	Current protection
4	Rated voltage	11	Manufacturer's logo
5	Maximum rated power	12	Approval marks and symbols (explained in chapter 1)
6	Serial number	13	QR code for serial number
7	Date of production		

6.5 Rotor and accessories installation

- Connect the centrifuge to the power source (mains socket at the back of the centrifuge).
- Turn on the centrifuge (switch on the side of the centrifuge).
- Open the cover of the centrifuge by pressing the COVER key. Before installing the rotor, check that the centrifugation chamber is free from contamination, e.g., dust, glass splinters, liquid residues that must be removed.
- Put the rotor on the motor axis by sliding it onto the cone as far as it will go (keeping the coaxially between the rotor and the motor axis).
- Screw the clamp into the motor shaft (clockwise), then tighten it firmly with the rotor wrench.
- Swinging rotors must be equipped with buckets in all seats.
- Container suspension pins should be regularly lubricated with technical petroleum jelly.
- In the case of rotors with a cover, they must not be used without the cover. Rotor caps must be screwed securely onto the rotor. The rotor and cover are marked with the same catalog number (REF) to eliminate the risk of incorrect selection when the user has several types of rotors. Rotor covers ensure lower rotor resistance, correct tube seating and airtight sealing.
- Only containers suitable for the selected type of rotor should be used.
- In order to increase the durability of the rotor and seals, it is recommended to lubricate the rotor pins used to suspend the containers, the undercuts for the pins in the containers, gaskets and threaded places with technical petroleum jelly.
- In order to replace the rotor, remove the tubes and containers, loosen the rotor clamp with the provided wrench, counterclockwise, and then use both hands to grasp the rotor on opposite sides and remove it from the motor axis by pulling it upwards.



It is recommended to equalize vessels loads as much as possible in order to ensure minimal vibrations during operation.

6.6 Control device

The microprocessor control unit of the centrifuge ensures broad possibilities of providing, realization and reading of work parameters.

6.7 Setting parameters

Data setting and read-out system forms hermetically closed keyboard with distinctly accessible operation points. Easily readable displays signalling individual performed operations facilitate operator's programming and recording of parameters and condition of the centrifuge.

The centrifuge is provided with the USB (only MPW M-UNIVERSAL) interface that enables connection of the centrifuge to external PC unit with the printer and recording the centrifugation parameters.

6.8 Safety features

Cover lock

The centrifuge can be started only with properly closed cover. While the cover can be opened only after stopping the rotor. In case of emergency opening of the cover during operation, the centrifuge will be immediately switched-off and the rotor will brake till complete stopping

Unbalance detecting

When loads of opposite buckets or carriers in rotors are unbalanced, the drive will be switched-off during acceleration or operation of the centrifuge – and the error message will be displayed.

Rotor verification and checking compatibility with loaded program

Directly after starting centrifuging, a unit verifies the type of the rotor applied and in the case of its incompatibility with the type indicated in the application or absence of the rotor, the spinning process shall be stopped with simultaneous displaying the error message. The conformity of the type of the rotor is signalled with a single audible signal. In case auto identification (see 9.8 Other) option is checked, proper rotor will be automatically chosen, without user engagement.

Rest state inspection

Opening of the centrifuge's cover is possible only with the rotor in the state of rest. When the rotor is being stopped, the STOP diode is on and goes off when it is stopped. (Excepting emergency cover opening) – see p. TROUBLESHOOTING.

6.9 Increase in temperature

In uncooled centrifuges, the temperature in the rotor chamber, rotor and sample can increase to above 40°C, based on the run time, g-force (RCF)/speed and ambient temperature.

7 Centrifuging

Power switching ON/OFF is carried out with master switch situated on the side wall of the centrifuge. All settings on the centrifuge are done by means of the control panel.

7.1 Control panel

The control panel placed on the front casing serves the purpose of controlling centrifuge operation.

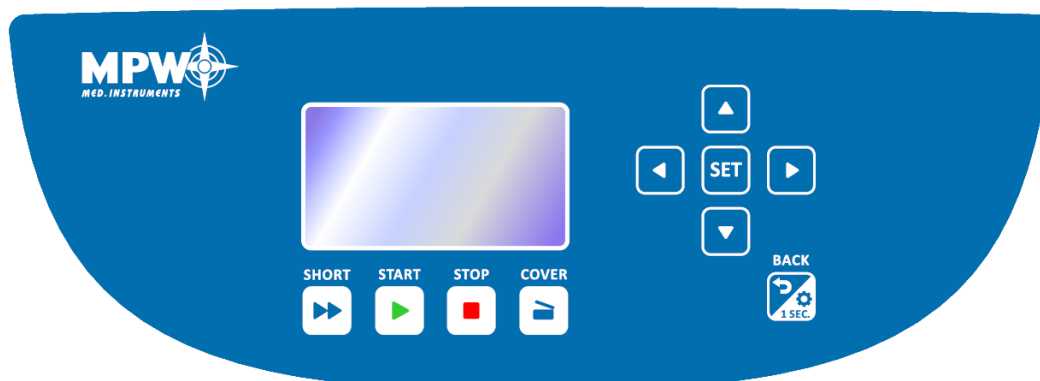

Control panel

	SHORT¹	short-time centrifuging
	START	start centrifugation run
	STOP²	end centrifugation run
	COVER	cover opening
	BACK/OPTIONS	exit the current menu / cancelling switching between rpm display mode and RCF display mode
	UP	navigation in menu / increasing values
	DOWN	navigation in menu / decreasing values
	LEFT	navigation in menu
	RIGHT	navigation in menu
SET	SET	changing parameters / confirming changes

¹ the centrifuge is working as long as the key is pressed

² first-time pressing – will make stopping centrifuging with acceleration characteristics set in the current program (confirm message with pressing **STOP** or **BACK** key),
second-time pressing – will make the centrifuging as fast as possible

7.2 Display

The display is located in the centre of the control panel. The main screen variants are presented below.



After switching on Centrifuge, welcome screen appears. When welcome screen disappears, it is possible to setting up parameters.

The user can choose between two types of screen.
 The **SIMPLIFIED SCREEN** is set by default.

TYPES OF MAIN SCREEN	
SIMPLIFIED DISPLAY (setting default)	NORMAL DISPLAY

7.2.1 Setting up RPM, RCF, TIME, temperature on the SIMPLIFIED DISPLAY

On the screen, it is possible to set:

ROTATING SPEED - RPM	SPEED
RELATIVE CENTRIFUGAL FORCE	RCF
CENTRIFUGING TIME	TIME

Exemplary change of **SPEED** or **RCF** setting:

or

- Press **SET** (to enter edit mode).
- With **▲▼** keys mark **SPEED** or **RCF** (the selected tab will be highlighted).
- Press **SET** (- blinking).
- Choose demanded order of magnitude by pressing **◀▶**.
- Set demanded value by pressing **▲▼**. Repeat above two steps for other orders of magnitude.
- Confirm set value by pressing **SET**.
- Leave edit mode by pressing **BACK**.

When RPM is changed, RCF is automatically corrected, and vice versa.

Exemplary change of **TIME** setting:

(set value)
[hour : min : sec]

current value
(most significant digits)

- Press **SET** (to enter edit mode).
- With **▲▼◀▶** keys mark **TIME**.
- Press **SET** (- blinking).
- Set demanded value by pressing **▲▼**.
- Choose "hours", "minutes" or "seconds" by pressing **◀▶**, e.g.: **00:02:00**. Repeat above two steps for other orders of magnitude.
- Confirm set value by pressing **SET**.
- Leave edit mode by pressing **BACK**.

HOLD mode - Continuous operation mode .To end centrifuging in HOLD mode press **STOP**.

- To run centrifuging in **HOLD** mode set **00:00:00** time.

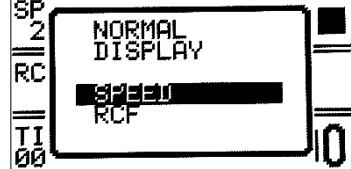

7.2.2 Switching between the screens

Switching the **SIMPLIFIED** display to **NORMAL** display:

	<p>Press the BACK button for 1 sec. to return to the basic display (a short menu is displayed on the screen)</p> <ul style="list-style-type: none"> Via ▲▼ keys select DISPLAY.
	<ul style="list-style-type: none"> Via ▲▼ keys select SPEED/RCF. <p>Depending on what you want it to appear on the NORMAL display.</p> <ul style="list-style-type: none"> Press SET

Switching the **NORMAL** display to **SIMPLIFIED** display:

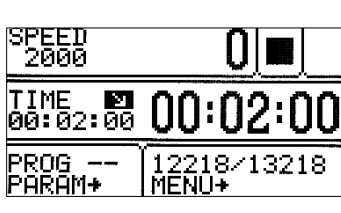
Method I.

	<ul style="list-style-type: none"> Press SET (to enter edit mode ). Via ▲▼◀▶ keys select MENU. Press SET. Via ◀▶ keys select CONFIGURATION tab. Press SET.
	<ul style="list-style-type: none"> Via ▲▼ keys select SIMPLIFIED DISPLAY tab. Press SET. Leave menu via BACK key x2.



Method II.

	<p>Press the BACK button for 1 sec. to return to the basic display (a short menu is displayed on the screen)</p> <ul style="list-style-type: none"> Via ▲▼ keys select SIMPLIFIED DISPLAY tab. Press SET.
---	---

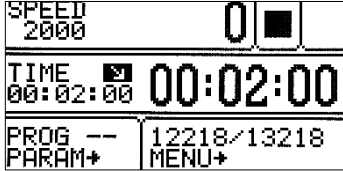
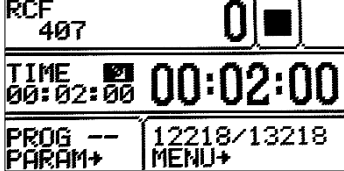
7.2.3 Setting up RPM, RCF, TIME, temperature on the NORMAL DISPLAY

NORMAL DISPLAY	
Display mode SPEED	Display mode RCF
	

Switching between display **SPEED** and **RCF**:

	<p>Switching between RPM and RCF display mode may be obtain by pressing and keeping key by 1s:</p> 
---	---

Exemplary change of **SPEED** or **RCF** setting:

	<ul style="list-style-type: none"> Press SET (to enter edit mode). With ▲▼◀▶ keys mark SPEED or RCF (wybrana zakładka podświetli się). Press SET (- blinking). Choose demanded order of magnitude by pressing ◀▶. Set demanded value by pressing ▲▼. Repeat above two steps for other orders of magnitude. Confirm set value by pressing SET. Leave edit mode by pressing BACK.
<p>or</p>	

When RPM is changed, RCF is automatically corrected, and vice versa.

Exemplary change of **TIME** setting:

	<ul style="list-style-type: none"> Press SET (to enter edit mode). With ▲▼◀▶ keys mark TIME. Press SET (- blinking). Choose "hours", "minutes" or "seconds" by pressing ◀▶, e.g.: 00:02:00. Set demanded value by pressing ▲▼. Repeat above two steps for other orders of magnitude. Confirm set value by pressing SET. Leave edit mode by pressing BACK.
<div style="border: 1px solid black; padding: 5px; margin-bottom: 5px;"> <p>(set value) [hh : mm : ss]</p> </div> <div style="border: 1px solid black; padding: 5px;"> <p>current value (most significant digits)</p> </div>	

HOLD mode - Continuous operation mode (To end centrifuging in HOLD mode press **STOP**).

	To run centrifuging in HOLD mode set 00:00:00 time.
--	---

7.3 Users programs

	After switching centrifuge on, program that was used in previous session is being loaded.
	Modification during run is represented by PROG -- symbol.

7.3.1 Program selection (Simplified display)

	Press the BACK button for 1 sec. to return to the basic display (a short menu is displayed on the screen)
	<ul style="list-style-type: none"> With ▲▼ keys mark PROG. Press SET.

Next, you should proceed in accordance with point. Choosing program.

7.3.2 Program selection (Basic display)

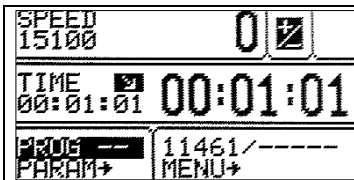

- Press **SET** (to enter edit mode )
- With **▲▼◀▶** keys mark **PROG.**
- Press **SET**.

7.3.2.1 Choosing program

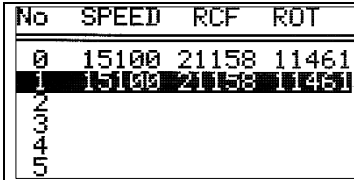

- The program list is displayed
- With **▲▼** keys choose demanded program number.
 - Press **SET** - the selection frame will appear.

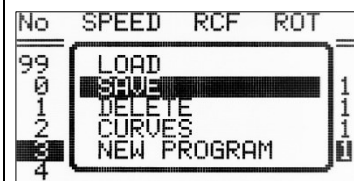

- With **▲▼** keys choose one of four possibilities
LOAD, SAVE, DELETE:
▶ – currently loaded program.

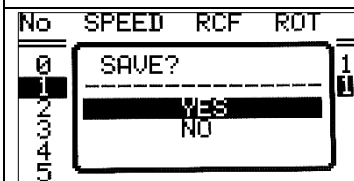



- Use the **▲▼** buttons to select:
LOAD – load program,
SAVE – save settings as a program (confirm by selecting **YES** and pressing **SET**).
DELETE – delete program (confirm by selecting **YES**).

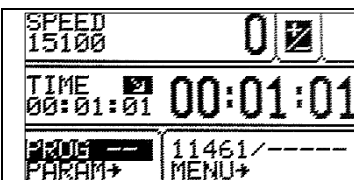

- NEW PROGRAM** – enter to create new program mode (as below).
- Press **SET**.
 - Press **BACK**.

7.3.2.2 Creating a new program



- Press **SET** (to enter edit mode )
 - Via **▲▼◀▶** keys mark **PROG.** field.
 - Press **SET**.
- The program list appears.

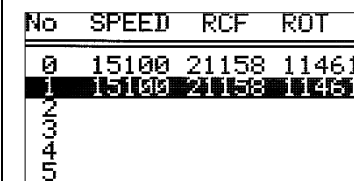

- Press **SET**.
- Selection frame appears.
- Via **▲▼** keys mark **NEW PROGRAM** field.
- Press **SET**.
- Set demanded parameters of centrifuging (look Screen).
- Via **▲▼◀▶** keys mark **PROG** field.
- Press **SET**.

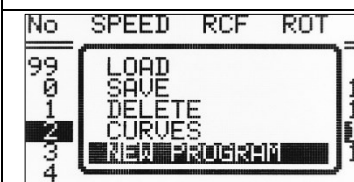

- The program list appears.
- Via **▲▼** choose demanded program number (0-99)
 - Confirm by **SET** pressing.
 - Via **▲▼◀▶** keys mark **SAVE** field.
 - Press **SET**.

	<p>Choose SAVE, a confirmation ask will appear, one should choose YES. The new program was created.</p> <p>To set it to work, one should choose LOAD.</p> <ul style="list-style-type: none"> ▪ Press SET. ▪ Via ▲▼ keys mark LOAD field. ▪ Press SET.
--	--

Changing parameters during run

There is a possibility to change parameters: **SPEED, RCF, TIME, and PARAM.** during centrifuging. Such modifications give in currently running program. Modification during run is represented by **PROG --** symbol (instead of the program number).

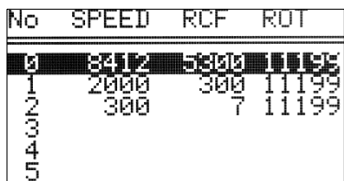
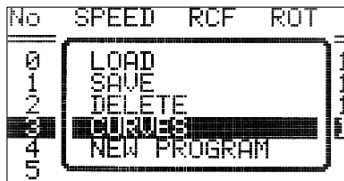
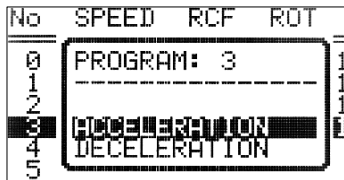

7.4 Creator of acceleration and deceleration curves

	PROG/CURVES
	<ul style="list-style-type: none"> ▪ With ▲▼ keys choose saved program for which you intend to create the acceleration or deceleration characteristics (marked with symbol ▶). ▪ Press SET. ▪ With ▲▼ keys choose CURVES. ▪ Press SET - the selection frame is displayed.
	
	<ul style="list-style-type: none"> ▪ With ▲▼ keys choose ACCELERATION to create acceleration characteristics or DECELERATION to create deceleration characteristics ▪ Confirm selection by pressing SET.

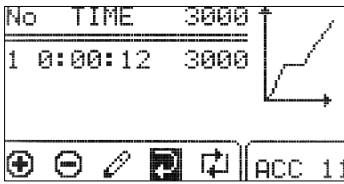
7.4.1 Acceleration characteristic, creation of episode 1

<p>Displayed alternately SPEED and 3000 (example):</p>  	No	section no. (max. 4)
	TIME	total acceleration time
	SPEED	final RPM
	ACC	characteristic's no. (10-19)
	⊕	adding a new section
	⊖	deleting last section
	✎	editing sections
	↶	exiting from characteristics wizard
	↷	switching RPM/RCF
	📈	entering graph view

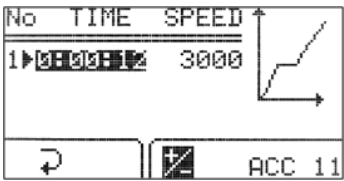
After entering the curve wizard, the symbol ↶ is highlighted. Pressing **SET** and selecting "NO" in response to the question "SAVE?" will return to the **PROG → CURVES** menu without making changes to the starting characteristics. To start editing the one-segment characteristics, select the icon ✎ with the ◀▶ keys and press the **SET** key.

	<div style="display: flex; align-items: center;">  <div style="margin-left: 10px;"> <p>editing value (flashing means editing the given value)</p> </div> </div> <ul style="list-style-type: none"> ▪ Press SET ▪ With ▲▼◀▶ choose time for section ▪ Press SET ▪ It is not possible to edit the maximum speed value. To do this, more sections have to be created, but the last section will always have the maximum set speed and cannot be changed. ▪ Select ◀▶ with ▼ ◀ buttons and press SET to finish editing characteristics.
---	--

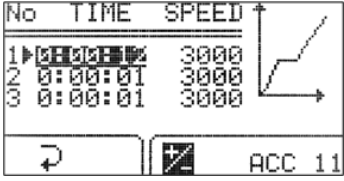

7.4.2 Adding and editing sections - acceleration

<p>To program next sections, select the ⊕ icon with the ◀▶ buttons and press SET. A new section (sections) will appear with a time of 1 second and a speed equal to the maximum speed.</p> <p>To start editing a newly added section (sections), select the ✎ icon with the ◀▶ buttons and press SET, and follow the instructions given below.</p> <p>After entering the profile section editing menu, the time value of the first section will be highlighted (see the picture below).</p>	
	<p>The maximum speed value for the section cannot be higher than the maximum speed value for the characteristic (for the last section).</p> <ul style="list-style-type: none"> ▪ With ▲▼◀▶ highlight time or speed for desired section ▪ Press SET ▪ With ▲▼◀▶ choose value ▪ Press SET ▪ Repeat until setting all the sections ▪ To finish editing characteristic with ▲▼◀▶ choose ◀▶ and press SET. Finishing edition can be also done by pressing BACK button.

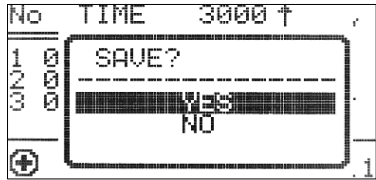
Saving created characteristic

	<ul style="list-style-type: none"> ▪ Select the ◀▶ icon with the ◀▶ buttons and press SET ▪ In the "Save?" window, use ▲▼ buttons to select YES to confirm saving the characteristic or NO, to exit without saving ▪ Press SET
---	---

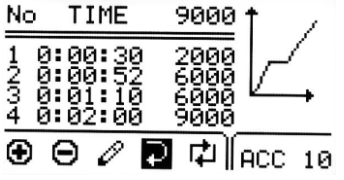
7.4.3 Acceleration graph

<p>An example of given parameters and a diagram:</p>	
	<p>After the time value programming is completed, the TIME + SPEED segment of the user's startup characteristic can be displayed graphically. The set section of the characteristic curve is illustrated on the graph, which can be displayed by selecting the icon  with the ◀▶ keys and pressing the SET key.</p>

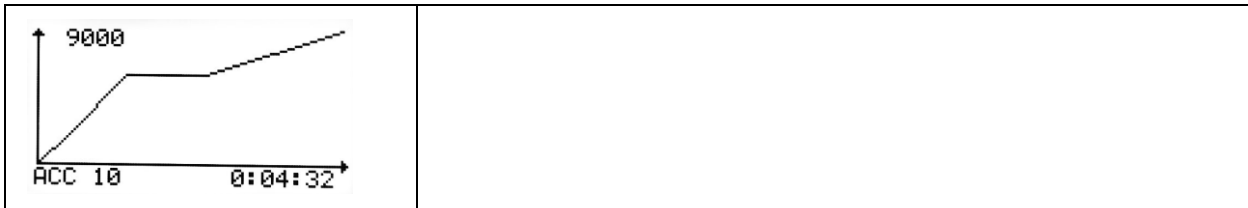

7.4.4 Deceleration characteristic, creation of episode 1

<p>SPEED or 3000 displayed (example):</p>	No	section no. (max. 4)
	TIME	total acceleration time
	SPEED	final RPM
	DEC	characteristic's no. (10-19)
		adding a new section
		deleting last section
		editing sections
		exiting from characteristics menu
		switching RPM/RCF
		entering graph view

After entering the curve wizard, the symbol is highlighted. Pressing **SET** and selecting "NO" in response to the question "SAVE?" will return to the **PROG → CURVES** menu without making changes to the starting characteristics. To start editing the one-segment characteristics, select the icon with the **◀▶** keys and press the **SET** key.

		editing value (flashing means editing the given value)
	<ul style="list-style-type: none"> ▪ Press SET ▪ With ▲▼◀▶ choose time for section ▪ Press SET ▪ To edit speed ▪ It is not possible to edit the minimum speed value. To do this, more legends must be created, but the last leg will always be "0". ▪ Select with ▼◀ buttons and press SET to finish editing characteristics 	

7.4.5 Adding and editing sections - deceleration

In order to program successive periods, select the icon with the **◀▶** keys and press the **SET** key. A new segment (or segments - after successive presses of SET) will appear with the time and speed equal to the minimum speed - "0".

To start editing the newly added sections, select the icon with the **◀▶** buttons, press **SET** and make the settings as described below.

After entering the profile section editing menu, the time value of the first section will be highlighted (see the picture below).

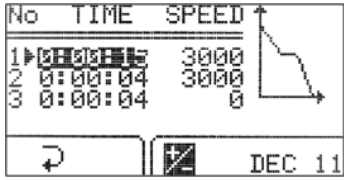

	<p>The speed value of the last segment will always be "0".</p> <ul style="list-style-type: none"> With ▲▼◀▶ highlight time or speed for desired section Press SET With ▲▼◀▶ choose value Press SET Repeat until setting all the sections To finish editing characteristic with ▲▼◀▶ choose ↻ and press SET. Finishing edition can be also done by pressing BACK button
---	--

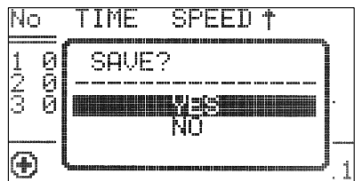
SAVING CREATED CHARACTERISTIC

	<ul style="list-style-type: none"> Select the ↻ icon with the ◀▶ buttons and press SET In the "Save?" window, use ▲▼ buttons to select YES to confirm saving the characteristic or NO, to exit without saving Press SET
---	--

7.4.6 Deceleration graph

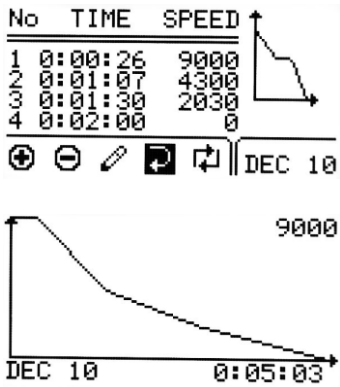
An example of given parameters and a diagram:

	<p>After programming the time value, you can graphically display the TIME + SPEED segment of the user's braking characteristic. The set section of the characteristic curve is illustrated on the graph, which can be displayed by selecting the icon  with the ◀▶ keys and pressing the SET key.</p>
---	---

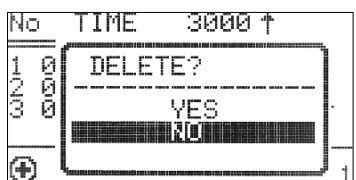

7.4.7 Deleting sections

In the characteristic's wizard:

	<ul style="list-style-type: none"> Select the ⊖ icon with the ◀▶ buttons and press SET In the "Delete?" window, use ▲▼ buttons to select YES to confirm deleting the characteristic section or NO to cancel Press SET
---	--

7.5 Programs with user characteristics

Loading a modified program in the **CURVES** fold is signaled by the icon on the main screen:

	<p>Icon  signals that program with user acceleration/deceleration characteristics are loaded.</p>
---	--

A change in any parameter entails the deactivation of the multi-section's curves mode.

7.6 Choosing rotors and container

7.6.1 Choosing rotors and container on the SIMPLIFIED SCREEN

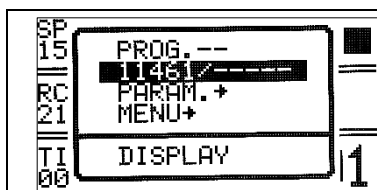



Press the **BACK** button for **1 sec.** to return to the basic display (a short menu is displayed on the screen)

- With **▲▼◀▶** keys mark **11213 / 13276** zone (rotor no. / container no.).
- Press **SET**

Next, you should proceed in accordance with point Choosing rotors and container.

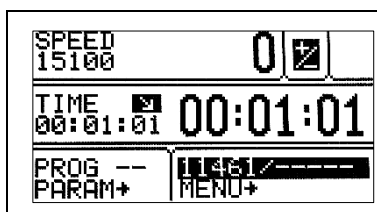

7.6.2 Choosing rotors and container on the BASIC DISPLAY





- Press **SET** (to enter edit mode ).
- With **▲▼◀▶** keys mark **11213/13276** zone (rotor no. / container no.).
- Press **SET**.

7.6.2.1 Choosing rotors and container

ROTOR	BUCKET	SPEED
11159		13000
11213	13276#U	5000
11216		14000
11217	13080#U	6000
>11461		15100
11462		14000

- 1) Selection of the rotor with a container marked :**
 - Use the **▲▼** keys to select the desired rotor or rotor number and the container marked .
 - Confirm the selection by pressing the **SET** key.
 - Press **BACK**.

- 2) Selection of the rotor with a container marked :**

-  - the ability to change the container.
 - Use the **▲▼** keys to select the desired rotor or rotor number and the container marked .
 - Press **SET**.
 - Use the **▲▼** to select the desired container.
 - Confirm the selection by pressing the **SET** key.
 - Press **BACK**.
 - You can move between screens with rotor parameters using the **◀▶** keys.
- 3) Selection of the rotor without container:**
 - Use the **▲▼** keys to select the desired rotor.
 - Press **SET**.

It is possible to set ROTOR AUTOIDENTIFICATION.

The procedure is described in the *Rotor automatic identification* chapter.

7.7 SHORT mode



In **SHORT** mode the centrifuge is working as long as the **▶▶** (SHORT) key is pressed or when set time is over. Centrifuging ends when the **SHORT** key is released.

7.8 Terminating centrifugation

STOPPING CENTRIFUGATION CYCLE

When preselected time is reached, centrifugation will end automatically.

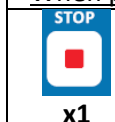

Pressing **STOP** for the first time will stop centrifuging with the characteristic set in loaded program. Confirm message by pressing **STOP**.



x2

Pressing **STOP** second time will stop centrifuging with the fastest characteristic.

The message may be extinguished with **STOP, SET, COVER, ▲▼◀▶** lub **BACK** button.

8 Parameters of centrifugation

8.1 Choosing parameters on the SIMPLIFIED SCREEN

	<p>Press the BACK button for 1 sec. to return to the basic display (a short menu is displayed on the screen)</p> <ul style="list-style-type: none"> With ▲▼◀▶ keys mark PARAM. field. Press SET.
--	---

After that follow instructions described in *Choosing centrifugation parameters* .

8.2 Choosing parameters on the BASIC DISPLAY

	<ul style="list-style-type: none"> Press SET (to enter edit mode). With ▲▼◀▶ keys mark PARAM. field. Press SET.
--	---

8.3 Choosing centrifugation parameters





It is possible to switch between two different screens Via **◀▶** keys.

	▲▼	
ACCELERATION	chosen acc. characteristic (0-the fastest, 9-the slowest)	
DECELERATION	chosen dec. characteristic (0-the fastest, 9-the slowest)	
RADIUS [mm]	current rotor radius [mm]	
DENSITY (g/cm3)	sample density [g/cm ³]	
AUT. LID OPEN	opening cover after centrifuging automatically	
START DELAY	starting delayed (after pressing START)	



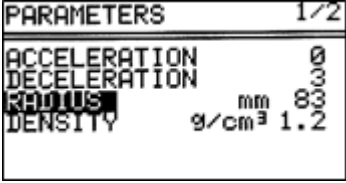

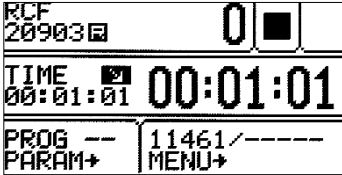
8.3.1 Accelerating/decelerating – changing characteristics

	ACCELERATION / DECELERATION	PARAM./ ACCELERATION / DECELERATION
		<p><u>ACCELERATION</u> – 10 linear accelerating characteristics assigned to every rotor. (0-the fastest, 9-the slowest)</p> <p><u>DECELERATION</u> – 10 linear decelerating characteristics assigned to every rotor (0 ÷ 9). (0-the fastest, 9-the slowest)</p> <ul style="list-style-type: none"> With ▲▼◀▶ keys mark ACCELERATION / DECELERATION fold Press SET (to enter edit mode). Set demanded value by pressing ▲▼. Press SET. Press BACKx2.

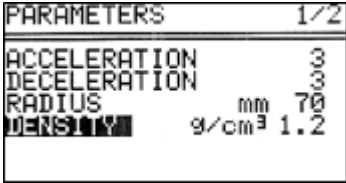

8.3.2 Radius

	RADIUS [mm]	PARAM./ RADIUS
		<p>Control of the radius of the rotor within the range from R_{min} to R_{max}. Available values depends on chosen rotor, see — / — (rotor number / container number)</p> <ul style="list-style-type: none"> With $\blacktriangle \blacktriangledown \blacktriangleleft \blacktriangleright$ keys mark RADIUS fold Press SET (to enter edit mode $\oplus \ominus$). Set demanded value by pressing $\blacktriangle \blacktriangledown$. Press SET. Press BACKx2.
<p>When radius is changed is activated,  symbol is visible on the screen. Displayed RCF will be computed in accordance with changed value of radius.</p>		
BASIC DISPLAY		SIMPLIFIED DISPLAY
		

8.3.3 Density

	DENSITY (g/cm³)	PARAM./ DENSITY
		<p>Default density is set to 1,2 g/cm³ (possible values 1,2 ÷ 9,9 g/cm³).</p> <ul style="list-style-type: none"> With $\blacktriangle \blacktriangledown$ keys mark DENSITY. Press SET $\oplus \ominus$ appears. Via $\blacktriangle \blacktriangledown$ keys choose demanded values. Press SET. Press BACKx2.
<p>When density is changed, symbol  is visible on the screen. Increasing density of the sample above 1,2 g/cm³ (and limiting of the maximum speed of centrifuging resulting from it) applies until switching off power supply of the centrifuge or setting the device back to 1,2 g/cm³.</p> <p>Increasing the density reduces the maximum speed of the rotor.</p>		
BASIC DISPLAY		SIMPLIFIED DISPLAY
		

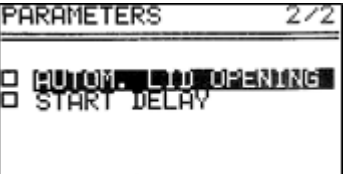
8.3.4 Automatic lid open

	Automatic lid open	PARAM. / AUTOM. LID OPENING
		<ul style="list-style-type: none"> Via $\blacktriangle \blacktriangledown \blacktriangleleft \blacktriangleright$ keys choose AUTOM. LID OPENING. Press SET (to switch off/on). Press BACKx2. <p>When centrifuge process is finished, cover will be opened automatically. When centrifuging is terminated by pressing STOP, opening cover is possible by pressing COVER.</p>
<p> symbol means that OPEN LID AFTER RUN is active.</p>		

BASIC DISPLAY	SIMPLIFIED DISPLAY
<p>SPEED 3000 3000 ▶</p> <p>TIME 00:01:01 00 00 42</p> <p>PROG -- 12218/13218 PARAM+ MENU+</p>	<p>SPEED 3000 3000 ▶</p> <p>RCF 916 916</p> <p>TIME 00:01:01 00 00 55</p>

8.3.5 STARY DELAY-OF TIME

Start centrifuging since preselected delay is reached.	PARAM.2/2/ STARY DELAY/OF TIME
<p>PARAMETERS 2/2</p> <p>□ AUTOM. LID OPENING</p> <p>□ START DELAY</p> <p>□ OF TIME → 0:00:01</p>	<ul style="list-style-type: none"> Via ▲▼ keys mark START DELAY. Press SET. Via ▼ keys mark OF TIME. Via ▶ keys mark field 0 : 0 0 : 05 (for example). Press SET - appears. Via ▲▼ keys SET demanded values. Press SET. Confirm by pressing SET. Start delay can be set from 0 : 0 0 : 0 1 to 9 : 5 9 : 5 9. Press BACKx2.
When START DELAY-OF TIME function is activated, symbol is visible on the screen.	
BASIC DISPLAY	SIMPLIFIED DISPLAY
<p>SPEED 3000 0 </p> <p>TIME ---:---:-- 00:00:53</p> <p>PROG -- 12218/13218 PARAM+ MENU+</p>	<p>SPEED 3000 0 </p> <p>RCF 916 0 </p> <p>TIME ---:---:-- 00:00:34</p>

8.3.6 Screen messages

End of centrifuging – manual mode	
<p>SPEED 2000 0 </p> <p>TIM 00: CYCLE INTERRUPTED ! 00</p> <p>TEMP +5°C +15 PRG-- 11716 +5°C +15 PARA+ MENU+</p>	Centrifuging may be stopped at the any moment via the STOP key. The information message: CYCLE CANCELLED will be displayed
End of centrifuging – manual mode	
<p>SPEED 2000 0 </p> <p>TIM 00: CYCLE FINISHED 15</p> <p>TEMP +5°C +15 PRG-- 11716 +5°C +15 PARA+ MENU+</p>	Stopping centrifuging in accordance the set time causes generating multiton audible signals (after stopping the rotor) and displaying the message FINISH OF CENTRIFUGING
Additional messages	
<p> SUPPLY DECAY WHILE CENTRIFUGING</p>	In case of power shortage while centrifuging, after repeated switching it on, the following error screen will be displayed: SUPPLY DECAY WHILE CENTRIFUGING
<p> INCORRECT ROTOR NUMBER ! ID: 11716</p>	Identified number of the installed rotor is not compatible with the number of rotor remembered in program.

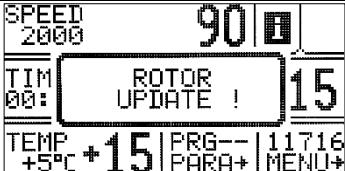
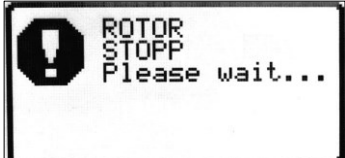
	<p>The rotor is automatically updated (when auto-identification is enabled).</p>
	<p>Rotor is braking (only when centrifuge was switched off during rotor running).</p>
<p>After pressing the STOP, SET, COVER, ▲▼◀▶ or BACK key, the device returns to the main screen.</p>	

Screen messages that may occur during operation.

MESSAGE	EXPLANATION
"SPEED OF ROTOR" "IDENTIFICATION <> 90 RPM"	SPEED OF ROTOR IDENTIFICATION <> 90 RPM
"IMBALANCE FAST STOP!" "PLEASE REMOVE CAUSE" "THEN RESTART"	UNBALANCE DETECTED
"NO ROTOR OR IDENTIFICATION" "SENSOR DAMAGED!"	ERROR OF ROTOR IDENTIFICATION {LIMIT OF 6SEC. IS OVER}
"INCORRECT ROTOR NUMBER!"	ROTOR'S IDNOT CORRECT
"WRONG DIRECTION OF ROTATION" "OR UNKNOWN ROTOR!"	WRONG DIRECTION OF ROTATION / UNKNOWN ROTOR
"PLEASE CLOSE THE LID" "HAND!"	CLOSING THE LID MANUALLY
"ROTOR STOPPING!" "Please wait..."	INITIALIZING AFTER MAINS FAILURE WITH ROTATING ROTOR
„CYCLE'S ABORTED!"	CENTRIFUGING ENDED BECAUSE OF PRESSING STOP
" CYCLE'S FINISHED"	CENTRIFUGING ENDED {WITHOUT ERRORS}

Emergency messages.

In case of emergency messages (centrifuge is not working properly) contact the manufacturer's authorized service centre.



MESSAGE
"OVERHEATING MOTOR!" "INVERTER ERROR!"
"INVERTER SERIAL BUS ERROR!"
"OPENING COVER in RUN!"
"SPEED METER ERROR"
"I2C BUS ERROR"
"ROTOR OVERSPEED!"
"COVER LOCK MALFUNCTION!"

9 Screen menu

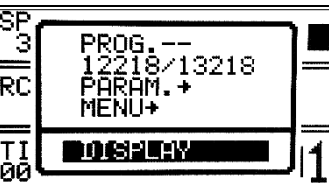

9.1 Starting MENU on the SIMPLIFIED DISPLAY

	<p>Press the BACK button for 1 sec. to return to the basic display (a short menu is displayed on the screen)</p> <ul style="list-style-type: none"> ▪ Via ▲▼ keys select MENU. ▪ Press SET.
<p>Next, you should proceed in accordance with point. <u>MENU navigation</u>.</p>	

9.2 Starting MENU on the NORMAL DISPLAY

	<ul style="list-style-type: none"> Press SET (to enter edit mode . Via ▲▼◀▶ keys select MENU. Press SET.
---	---

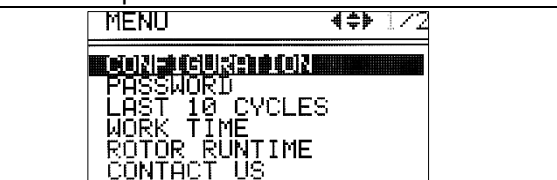
9.3 MENU navigation



<ul style="list-style-type: none"> Moving in the MENU is possible via ▲▼◀▶ keys. To open demanded field one should mark it and press SET. 		
		

CONFIGURATION	centrifuge configuration
PASSWORD	password protection
LAST 10 CYCLES	10 last centrifugation cycles history
WORK TIME	total working time, working cycles counter
ROTOR RUNTIME	counting time mode
CONTACT US	manufacturer's details
DIAGNOSTICS	error codes (service field)
FACTORY SETTINGS	restore factory settings

9.4 Configuration

MENU/CONFIGURATION	
	<ul style="list-style-type: none"> With ▲▼ keys select CONFIGURATION. Press SET.

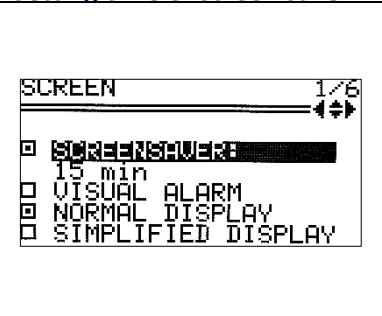
9.4.1 Screen saver

Setting time of screen saver	MENU / CONFIGURATION / SCREEN
	<ul style="list-style-type: none"> With ◀▶ keys select SCREEN 1/6. With ▲▼ keys select SCREENSAVER. Press SET. With ▲▼ keys choose 15 min. Press SET ( - activates the editing mode). With ▲▼ keys select demanded value from 1 to 60 minutes. Mark selection by pressing SET. Leave the menu by pressing BACK two times.

9.4.2 Visual alarm

Visual alarm	MENU / CONFIGURATION / SCREEN
	<ul style="list-style-type: none"> With ◀▶ keys select SCREEN 1/6. Via ▲▼ keys choose VISUAL ALARM. Mark it by pressing SET. Leave the menu by pressing BACKx2. <p>VISUAL ALARM cause blinking screen after ending of centrifuging or after error occurring.</p>

9.4.3 Counting time

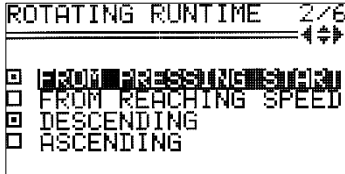
The method of counting time	MENU/CONFIGURATION/ ROTATING RUNTIME
	<ul style="list-style-type: none"> With ◀▶ keys select ROTATING RUNTIME 2/6. Via ▲▼ choose demanded option. Mark it by pressing SET. Leave menu via BACK keyx2.
Counting since:	
FROM PRESSING START	Counting since rotor is identified
FROM REACHING SPEED	Counting from assigned speed
Presenting mode:	
DESCENDING	Counting down
ASCENDING	Counting up

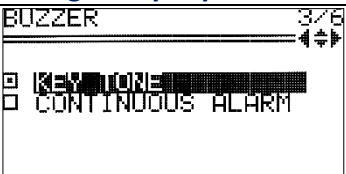

9.4.4 Buzzer

Switching ON/OFF short audible signals accompanying every pressing of any key.	MENU/ CONFIGURATION /BUZZER
	<ul style="list-style-type: none"> With ◀▶ keys select BUZZER 3/6. With ▲▼ keys select demanded option. Mark selection by pressing SET. Leave menu via BACK key x2.
Warning signals are always switched on.	

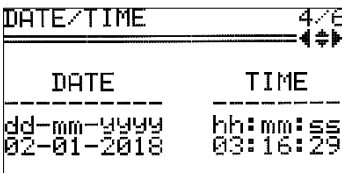
9.4.5 Date/time

Setting up time and date	MENU/ CONFIGURATION /DATE/TIME
	<ul style="list-style-type: none"> With ◀▶ keys select DATE/TIME 4/6. Press SET. Via ◀▶ keys choose demanded value. Press SET. Via ▲▼ keys change chosen value. Confirm by pressing SET. Repeat above steps for other values. Press BACKx2.
Set date and time are still active even after restart of centrifuge.	

9.4.6 Language

Changing menu language	MENU / CONFIGURATION / LANGUAGE
<ul style="list-style-type: none"> With ◀▶ keys select LANGUAGE 5/6. Via ▲▼ keys choose demanded menu language. Mark it by pressing SET. Press BACKx2. 	
	

9.4.7 Rotor automatic identification

Rotor automatic identification	MENU / CONFIGURATION / OTHER
<p>Thanks to the AUTOMATIC IDENTIFICATION, the centrifuge automatically identifies the rotor in the chamber. Rotor identification is indicated by the message.</p> <p>When the function is deactivated, it is necessary to manually select the desired rotor as described in <i>Choosing rotors</i>.</p>	
	<p>The AUTOMATIC IDENTIF. is turned on by default.</p> <p>Aby włączyć funkcję należy:</p> <ul style="list-style-type: none"> ▪ With ◀▶ keys select OTHER 6/6. ▪ Via ▲▼ keys choose. ▪ <input type="checkbox"/> AUTOMATIC IDENTIF. ▪ Press SET (<input type="checkbox"/> change to <input checked="" type="checkbox"/>). ▪ Press BACKx2.
<p>Warning!</p> <p>After automatic detection of the rotor, check that the container number is correct, for example 11213/13276 (rotor number / container number).</p> <p>In the AUTOIDENTIFICATION process, the rotor is automatically detected.</p> <p>It is necessary to set the container manually in accordance with section <i>Choosing rotors and container</i>.</p>	

9.4.8 Service inspection

	MENU / CONFIGURATION / OTHER
	<p>There is a possibility to turn on a message reminding user to perform the inspection, with the option to define the date of the inspection when the message will be displayed.</p> <p>To enable/unable the function:</p> <ul style="list-style-type: none"> ▪ Via ▲▼ keys choose <input type="checkbox"/> SERVICE INSPECTION. ▪ Press SET (<input type="checkbox"/> change to <input checked="" type="checkbox"/> or conversely). <p>A new field will appear with the date of the inspection (on that day message will be displayed).</p> <p>To edit the date:</p> <ul style="list-style-type: none"> ▪ Via ▲▼ keys select date field. ▪ Press SET. ▪ Via ▲▼◀▶ keys choose value. ▪ Confirm by pressing SET.

9.5 Password

Setting up password	MENU / PASSWORD
<p>To prevent from an unauthorized use, a PASSWORD can be set.</p> <p>Note: No PASSWORD is set by default.</p> <p>The PASSWORD can be set as follows when the rotor is at a standstill.</p>	
	<ul style="list-style-type: none"> ▪ Press the ▲▼ keys until PASSWORD. ▪ Press SETx2. ▪ With ▲▼ keys set the valid 1000s place of the PASSWORD. e.g.: 1xxx.

<div style="border: 1px solid black; padding: 5px;"> <p>PASSWORD</p> <hr/> <p>CONFIRM:</p> <div style="border: 1px solid black; padding: 2px; display: inline-block; margin: 5px;">0000</div> </div>	<ul style="list-style-type: none"> ▪ Press ►. ▪ With ▲▼ keys set correct value. ▪ Repeat above steps for all places. ▪ Press SET. <p>As a confirmation repeat instructions described above.</p>
--	--

When the **PASSWORD** is set, the Key sign is displayed in the **CODE** zone.
It is also displayed in the main menu (in the upper right corner of the screen).

<div style="border: 1px solid black; padding: 5px;"> <p>SPEED 12000 0 ■ ?</p> <hr/> <p>TIME 00:02:00 00:02:00</p> <hr/> <p>TEMP +20°C +21 PRG-- 11944 +20°C +21 PARA+ MENU+</p> </div>	<p>From then on, access to the MENU is possible after entering the password. In case of incorrect password, it will show message: ACCESS DENIED</p>
--	---

To delete the **PASSWORD**, "0000" must be set.
If the **PASSWORD** is forgotten, the emergency code "7654" should be used to clear password and remove all locks.

Setting up locks

<div style="border: 1px solid black; padding: 5px;"> <p>LOCK:</p> <hr/> <p><input type="checkbox"/> SAVE PROGRAM</p> <p><input type="checkbox"/> DELETE PROGRAM</p> <p><input type="checkbox"/> CHANGE PARAMETERS</p> <p><input type="checkbox"/> LOAD PROGRAM</p> <p><input type="checkbox"/> START KEY</p> </div>	<ul style="list-style-type: none"> ▪ With ▲▼ keys choose a lock. ▪ Mark a lock by pressing SET. ▪ Repeat above steps for desired locks. ▪ Leave menu with BACK key x2.
---	--

LOCKS*	DESCRIPTION
SAVE PROGRAM	<ul style="list-style-type: none"> ▪ no programs can be saved.
DELETE PROGRAM	<ul style="list-style-type: none"> ▪ no programs can be deleted. ▪ saving programs on position where one was already stored is disabled.
<p>CHANGE PARMETERS</p> <p>Fields:</p> <ol style="list-style-type: none"> 1. SPEED 2. RCF 3. TIME 4. PROG 5. — / — 6. PARAM 	<ul style="list-style-type: none"> ▪ parameters can not be modified.
LOAD PROGRAM	<ul style="list-style-type: none"> ▪ no programs can be called up.
START KEY	<ul style="list-style-type: none"> ▪ centrifugation can not be started.

* Executing disabled procedures is only possible after entering the correct.

9.6 10 cycles

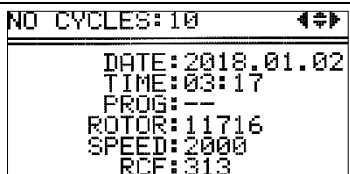
Information concerning parameters of last 10 centrifuging cycles.	MENU / LAST 10 CYCLES
	<ul style="list-style-type: none"> Press the ▲▼ keys until 10 CYCLES. Press SET. Number of cycle can be changed by ◀▶ keys. The list can be scrolled using ▲▼ keys. To exit press BACK key x3.

9.7 Work time

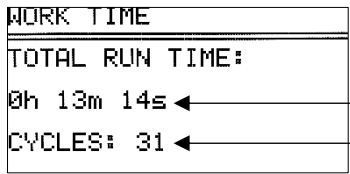
Total working time of centrifuge	MENU/ WORK TIME
	<ul style="list-style-type: none"> Press the ▲▼ keys until WORK TIME. Press SET. <p>The tab informs about the total working time of the centrifuge and number of cycles.</p> <p>total working (centrifugation) time</p> <p>working cycles counter</p> <ul style="list-style-type: none"> Press BACKx3.

9.8 Rotor cycles

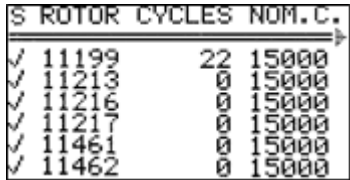
Information about the time of centrifuging and of the quantity of the working cycles of each rotor. The table also contains icons warning of the duty of execution of validation.	MENU / ROTOR RUNTIME
	<ul style="list-style-type: none"> Press the ▲▼ keys until ROTOR RUNTIME. Press SET. The list can be scrolled using ▲▼ keys. To exit press BACK key x2. <p>Symbols:</p> <ul style="list-style-type: none"> ✓ – more than 100 cycles left ! – less than 100 cycles left ! – worn rotor -> Rotors marked as worn must not be used.

9.9 Manufacturer's details

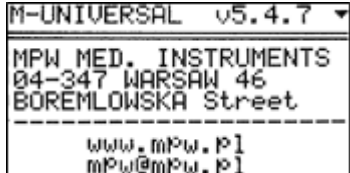
Information about the type of the centrifuge, firmware version, and contact details.	MENU / CONTACT US
	<ul style="list-style-type: none"> Press the ▲▼ keys until CONTACT US. Press SET. The list can be scrolled using ▼▶ keys. To exit press BACK key x2.

9.10 Diagnostics

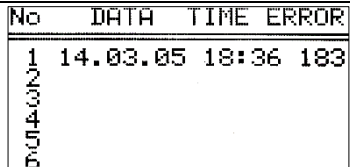
Information about errors arisen in working of the centrifuge.	MENU / DIAGNOSTICS
	<ul style="list-style-type: none"> Press the ▲▼ keys until DIAGNOSTICS. Press SET. <p>For service staff!</p>

9.11 Factory settings

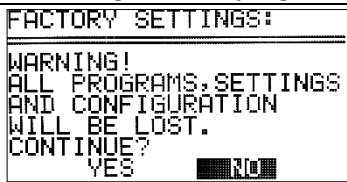
Restoring factory settings.	MENU / FACTORY SETTINGS
All settings of user programs will be deleted.	
	<ul style="list-style-type: none"> Press the ▲▼ keys until FACTORY SETTINGS. Press SET. Via ◀▶ keys choose YES or NO. Confirm by pressing SET.

10 Report printout – USB (M-UNIVERSAL only)

When the centrifuging process is finished there is a possibility to obtain report. Report can be transferred to PC or printed.

PC (USB)

The elements needed to make connecting your computer via USB:

name	quantity (pcs.)	cat. No.
USB A-A cable	1	16655
MPW Editor 2 application	1	to downloaded from the website: www.mpw.pl Tab: DOWNLOAD/OTHER

Preparation

- Install **MPW Editor 2** application on the computer. Program is available for download from our website at **www.mpw.pl**. Operating System Requirements: **Microsoft Windows 10 (64bit)**. The Manufacturer does not guarantee that the program will work correctly with other operating systems.
- If necessary install **FTDI USB drivers** and **.NET Framework 4.0** library (download with manufacturer's website: **www.mpw.pl**)

Centrifuging and printing

- Run **MPW Editor 2** application.
- Choose **Language\English**

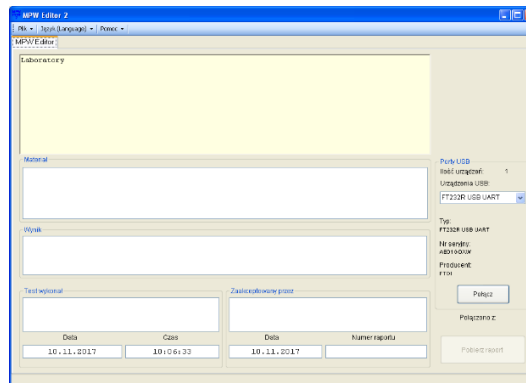

- Connect centrifuge to the PC in accordance with the „**Connection scheme**”
- Choose port assigned to the centrifuge (it will appear after connecting USB cable). Attention: If the interface has not been programmed: name, serial number and manufacturer’s name, the device will be identified by Windows and MPW Editor 2 with the data programmed by FTDI (manufacturer USB integrated circuit) for example FT232R USB UART.
- Choose **File\Edit form**

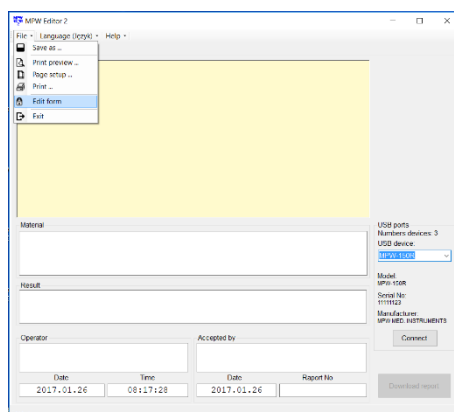

In the „Tytuł (Title)” field, you can place any text, for example name of the laboratory, for later use in the report template.

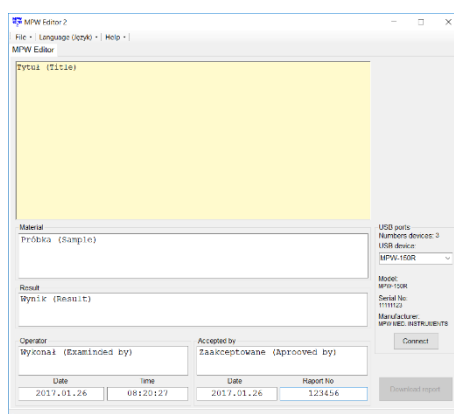

- Choose **File\Save form**.
- Ensure that USB device is selected from the list of devices.
- Press Connect. After successful communication, "PC" appears in the display.

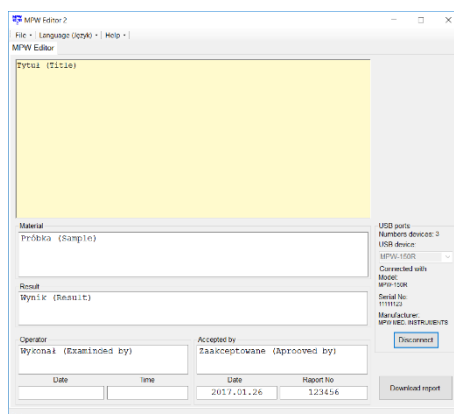

- Fill folds: „Material”, „Result”, „Operator”, „Accepted by”, „Raport no” (optionally).
- When the centrifuging process is finished, press **Download the report**.
- When centrifuging process is completed, report will appear.
- Save report (**File/Save as**) or print it (**File/Print**).
- In order to get another report, press New test and press Download the report.
- After finishing the work, press **Disconnect** button (the "PC" disappears from the display of the centrifuge) and then closes MPW Editor 2.

Connection diagram



11 Maintenance

11.1 *Cleaning of the centrifuge*

	<p>For cleaning, water with soap or other water soluble mild detergent shall be used. One should avoid corrosive and aggressive substances. It is prohibited to use alkaline solutions, inflammable solvents or agents containing abrasive particles.</p> <ul style="list-style-type: none">▪ Do not lubricate the centrifuge motor shaft.▪ The unused centrifuge should have cover opened. <p>Once a week Using wiping cloth, remove condensate or residues of the products from the rotor chamber.</p> <p>Once a month Check the rotor clamping thread. In case of damage, replaced it. Check the centrifuging chamber whether it is damaged. In case of damage it can not be longer put into operation. Notify authorized service workshop.</p>
---	---

11.2 *Maintenance of centrifuge elements*

	<p>In order to increase the durability of threaded places in containers, lids and horizontal rotor suspension pins, lubricate with technical petroleum jelly.</p> <p>Make sure that the sealing rings (rubber) of the containers are thinly coated with silicone grease for vacuum in order to maintain tightness (catalog number 17201 - element of basic equipment).</p>
---	--

Cleaning of the accessories

	<ul style="list-style-type: none">▪ In order to ensure safe operation, one shall carry out in regular way periodical maintenance of the accessories.▪ Rotors, buckets, and round carriers have to withstand high stresses originating from the centrifugal force. Chemical reactions as well as corrosion (combination of variable pressure and chemical reactions) can cause destruction of metals.▪ Hard to observe surface cracks increase gradually and weaken material without visible symptoms. <p>Wipe rotor's pins clean and dry with a paper towel after approx. 400 uses, cleaning or/and autoclaving and then lubricate socket with the petroleum jelly (catalogue no. 17201).</p> <ul style="list-style-type: none">▪ In case of observation of surface damage, crevice, or other change, as well as the corrosion, the given part (rotor, bucket, etc.) shall be immediately replaced.▪ Clamping rotor, containers and reducer inserts must be cleaned regularly to prevent corrosion.▪ Cleaning of the accessories shall be carried out outside of the centrifuge once every week or still better after each use. For cleaning them one should use neutral agent of pH value 6÷8. It is forbidden to use alkaline agent of pH > 8. Then, those parts shall be dried using soft fabric or in the chamber drier at ca. 50°C.
---	---

	<ul style="list-style-type: none"> ▪ Angle rotor should be placed on a fabric with holes facing down, for effective drying. ▪ Do not use bleach on plastic parts of the rotor. ▪ In this way, the useful service life of the device is substantially increased and susceptibility to corrosion is diminished. Accurate maintenance increases the service life as well and protects against premature rotor failures. <p>Does not use bleach on plastic parts of the rotor.</p> <p>According to laboratory standards, minimize the immersion time in each solution.</p> <ul style="list-style-type: none"> ▪ Especially prone to the corrosion are parts made of aluminium. ▪ Corrosion and damages resulting from insufficient maintenance could not be subject of claims lodged against the manufacturer. ▪ The unused rotor should have the lid removed.
--	--

HS accessories maintenance:

	<ul style="list-style-type: none"> ▪ Check the general condition of seals. ▪ Make sure that rubber O-rings are lightly coated with silicone grease. Use high vacuum grease, e.g., type „C” by LUBRINA. ▪ The rotor pins shall be always lubricated with petroleum jelly.
---	--

11.3 Sterilization

Plastics - legend to abbreviations

PS	-	polystyrene	ECTFE	-	ethylene/chlorotrifluoroethylene
SAN	-	styrene-acrylonitrile	ETFE	-	ethylene/tetrafluoroethylene
PMMA	-	polymethyl methacrylate	PTFE	-	polytetrafluoroethylene
PC	-	polycarbonate	FEP	-	tetrafluoroethylene/perfluoro propylene
PVC	-	polyvinyl chloride	PFA	-	tetrafluoroethylene/perfluoroalkylvinylether
POM	-	acetal polyoxymethylene	FKM	-	fluorocarbon rubber
PE-LD	-	low density polyethylene	EPDM	-	ethylene propylene diene
PE-HD	-	high density polyethylene	NR	-	natural rubber
PP	-	polypropylene	SI	-	silicon rubber
PMP	-	polymethyl pentene			

One can use all standard disinfectants. Centrifuges and devices are made of different materials, one should consider their variety.

	radiation β radiation γ 25 kGy	C_2H_4O (ethylene oxide)	formalin, ethanol
PS	●	○	●
SAN	○	●	●
PMMA	●	○	●
PC	●	●	●
PVC	○	●	●
POM	●	●	●
PE-LD	●	●	●
PE-HD	●	●	●
PP	●	●	●
PMP	●	●	●
ECTFE, ETFE	○	●	●
PTFE	○	●	●
FEP, PFA	○	●	●

FKM	○	●	●
EPDM	○	●	●
NR	○	●	●
SI	○	●	●

- can be used
- do not use

In the centrifuge, disinfectants and cleaning agents generally used in medical care should be used (e.g., Aerodesina-2000, Lysoformin 3000, Melseptol, Melsept SF, Sanepidex, Cutasept F).

11.4 Autoclaving

- Rotors, buckets, and inserts may be autoclaved at 121 ° C for 20 minutes (215kPa), unless otherwise stated in the ADDITIONAL EQUIPMENT.
- When sterilizing with steam (autoclaving), take the temperature resistance of the individual materials into account.
- During autoclaving, deformation of plastic accessories, such as inserts and covers, cannot be ruled out.
- It is not planned to autoclave disposable materials, e.g., test tubes, Cyto inserts.
- The service life of the accessories depends essentially on the frequency of autoclaving and use.
- Frequent, repeated autoclaving reduces the service life of plastic components. They should be replaced when there is any sign of damage, including a change in colour or shape, or if leakage occurs etc.
- Frequent steam sterilization (autoclaving) reduces the mechanical strength! PC tubes may become unusable.
- Pressure in closed containers etc. may deform the plastic parts or cause an explosion.
- Before autoclaving impellers and accessories, wash them thoroughly and rinse with distilled water.
- Never exceed the permissible autoclaving temperature and time.
- In order to maintain hermetic seals, it is recommended to replace the sealing rings after each autoclaving.

The resistance of plastics to autoclaving

	autoclaving 121 °C, 20 min		autoclaving 121 °C, 20 min
PS	○	PMP	●
SAN	○	ECTFE, ETFE	●
PMMA	○	PTFE	●
PC	●	FEP, PFA	●
PVC	○ ¹⁾	FKM	●
POM	●	EPDM	●
PE-LD	○	NR	○
PE-HD	○	SI	●
PP	●		

● may be used

○ cannot be used

¹ Except PVC hoses which are resistant to the steam sterilization in the temperature 121 °C.

11.5 Chemical resistance

Chemical resistance of plastics

	aldehydes	cyclic alcohols	esters	ether	ketones	strong or concentrated acids	weak or diluted acids	oxidizing substances	cyclic hydrocarbons	ahs	haloid hydrocarbons	alkalis
PS	○	●	○	○	○	○/●	○/●	○	○	○	○	●
SAN	○	●	○	○	○	○	○/●	○	○	○	○	●
PMMA	○/●	●	○	○	○	○	○/●	○	○/●	○	○	○
PC	○/●	●	○	○	○	○	○/●	○	○/●	○	○	○
PVC	○	●	○	○	○	●	●	○	●	○	○	●
POM	○/●	●	○	●	●	○	○	○	●	●	●	●
PE-LD		●	●	●	○/●	●	●	○	●	●	●	●
PE-HD	●	●	○/●	○/●	○/●	●	●	○	●	○/●	○/●	●
PP	●	●	○/●	○/●	○/●	●	●	○	●	○/●	○/●	●
PMP	○/●	●	○/●		○/●	●	●	○	○/●	○	○	●
ECTFE, ETFE	●	●	●	●	○	●	●	●	●	●	●	●
PTFE, FEP, PFA	●	●	●	●	●	●	●	●	●	●	●	●
FKM	●	○	○	○	○	○	●	○/●	○/●	○/●	○/●	○/●
EPDM	●	●	○/●	○	○/●	●	●	○/●	○	○	○	●
NR	○/●	●	○/●	○	○	○	○/●	○	○	○	○	●
SI	○/●	●	○/●	○	○	○	○/●	○	○	○	○	○/●

● very good

Permanent action of the substance does not cause damage through 30 days. The material is able to be resistant through years



○/● good to limited

Continuous action of the substance causes insignificant and partly reversible damage through the period of 7-30 days (e.g., puffing up, softening, reduced mechanical durability, discolouring).

○ limited







The material should not have the continuous contact with the substance. The immediate occurrence of damage is possible (e.g., the loss of mechanical durability, deformation, discolouring, bursting, and dissolving).

Standard disinfectants can be used. Centrifuges and accessories are made of a variety of materials, the diversity of which should be considered. Do not use chlorine bleach to clean the aluminium impellers.

	DANGER!
	MPW accessories are not biotight. For centrifuging infectious materials it is necessary to use hermetically closed tubes meeting demands of biotightness, in order to prevent germs migration into the centrifuge and beyond it.
	User is responsible for proper disinfections of the centrifuge, if some dangerous material was spilled inside or outside of the centrifuge. During the above mentioned works one must wear safety gloves.

12 Troubleshooting

Majority of faults could be removed by restart the centrifuge. After switching the centrifuge ON, there shall be displayed parameters of the recently implemented program and sound signals comprising four successive tones shall be generated. In case of short-duration power failure the centrifuge terminates the cycle and displays PROGRAM ERROR code.

PROBLEM	QUESTION	ANSWER
Centrifuge does not start	<i>Is supply cable plugged into mains?</i>	<i>Plugs supply cable correctly.</i>
	<i>Is main switch ON?</i>	<i>Switch ON power supply.</i>
Motor error is displayed		Call service.
Centrifuge does not start (indications are proof for cycle in progress and motor does not start)	<i>Is  symbol displayed?</i>	Wait till rotor stops and the  symbol goes off.
	<i>Is  symbol displayed?</i>	Close cover  symbol must switch off.
	<i>Is  symbol blinking?</i>	Centrifugation cycle in progress, press STOP key or wait till cycle ends.
Centrifuge does not accelerate (unbalance error)	<i>Unequal rotor load.</i>	Centrifuge load shall be balanced.
	<i>Inclined centrifuge.</i>	Centrifuge shall be levelled.
	<i>Faulty drive (mechanical damage).</i>	Call service.
	<i>Was centrifuge displaced during operation?</i>	Switch ON the centrifuge again after opening and closing the cover.
(rotor error)	<i>After stopping error rotor message is displayed</i>	Check if rotor number in started program is consistent with the number of the rotor installed in the centrifuge. Check rotor status (if there are coding magnets inserted)
	<i>Centrifuge does not recognize the rotor and does not stop.</i>	Switch the centrifuge OFF, then ON and check correctness of loaded program
It is not possible to open the cover	<i> symbol on the display is blinking, after pressing COVER key single tone is audible</i>	Rotor is still rotating. Wait for stopping of the rotor and displaying of the  symbol.
	<i>The sensor is connected correctly, and the error is still applying.</i>	Call service.
Mains failure during run	<i>The message will be displayed on the display about the decay of tension.</i>	Wait for stopping of the rotor, clear the error by pressing the SET key.

12.1 Emergency cover release

	EMERGENCY COVER RELEASE
	<p>Attention! <i>The cover may be opened in emergency only when the rotor is at rest. Before emergency opening the cover, switch off the mains power switch and disconnect the power cord. Wait 10 min and/or looking through the sight glass, make sure that the rotor is not rotating.</i></p> <p>There is a plug on the right-hand side, which must be unscrewed counterclockwise using the emergency lid release key (catalog no. 18640). Then pull on the cap until the cover is open.</p> <p>The emergency opening of the cover can be used, for example, in the event of a power failure, failure of the control panel, etc.</p>

13 Guarantee

Manufacturer grants to the Buyer the guarantee on conditions specified in the Guarantee Certificate. Buyer forfeits the right to guarantee repair when using the device inconsistently with the User manual provisions, when damage results from the User's fault.

Repairs should be carried out in authorized service workshops, granted with the MPW Certificate.

The centrifuge shall be sent to repair after decontaminating disinfections. Information about authorized service workshops could be obtained from the Manufacturer.

	<ul style="list-style-type: none"> ▪ Guarantee period amounts to 24 months (unless otherwise specified in the purchase documents). ▪ Guarantee conditions are described in guaranteed card. ▪ The service life of the centrifuge specified by the manufacturer amounts to 10 years. ▪ After 24 months from the start of the warranty period (date of purchase), a technical inspection of the centrifuge should be conducted (validation) by an authorized service of the manufacturer. Subsequent inspections should be conducted at annual intervals. ▪ Maximum period of storage of not used centrifuge amounts to 1 year. After this period, a service authorized by manufacturer should conduct technical inspection of the centrifuge. ▪ Manufacturer reserves the right to make technical changes in manufactured products.
---	--

14 Transport and storage

	<p>CAUTION! Due to the heavy weight of the device, lifting and carrying it may cause injury to the spine.</p>
<ul style="list-style-type: none"> ▪ Store the device only in a closed and dry room. ▪ Remove rotor from centrifuge before transport. ▪ Lift and carry with the adequate number of people. ▪ Use transport equipment. ▪ Use the original packaging and transport protection for transport. 	

Transport and storage conditions.

	Storage (in the package)	Storage (without the package)	Transport
Temperature	-25 ÷ +55 °C	-5 ÷ +45 °C	-25 ÷ +60 °C (general) -20 ÷ +55 °C (air)
Relative humidity	10 ÷ 75 %	10 ÷ 75 %	10 ÷ 75 %
Pressure	70 ÷ 106 kPa	70 ÷ 106 kPa	30 ÷ 106 kPa

15 Disposal



- Dispose of the device in accordance with the applicable legal regulations in the country of use.
- In the countries of the European Community, the disposal of electrical equipment is regulated under the EU Directive 2012/19/EU on waste electrical and electronic equipment (WEEE). According to these regulations, centrifuges may not be collected together with municipal or household waste.
- Disposal regulations in individual EU countries may differ. In case of doubt, please contact the supplier of the device.

16 Manufacturer's info

"MPW MED. INSTRUMENTS" SPÓŁDZIELNIA PRACY

Boremlowska 46 Street

04-347 Warsaw

tel. (+48) 22 610 56 67 (sales department - POLAND)
(+48) 22 879 70 46 (sales department - outside POLAND)
(+48) 22 610 81 07 (service)

fax: (+48) 22 610 55 36

e-mail: mpw@mpw.pl

website: www.mpw.pl

000042924 - number of entry in the Waste Database

PL/CA01-01782 - identification number given by Office for Registration of Medicinal Products, Medical Devices and Biocidal Products.

Distributor's info

DISTRIBUTOR:

17 Annexes

A. Wyposażenie dodatkowe/Optional accessories**MPW M-UNIVERSAL****WIRNIK / ROTOR**PARAMETRY WIRNIKA / ROTOR PARAMETERS (RCF [x g], Rmax [mm], ϕ [°])

POJEMNIK/BUCKET

WKŁADKA / ADAPTER

[liczba probówek na wirnik/tubes per rotor] PROBÓWKA / TUBE

11199**RPM 18000 RCF 24270 Rmax 67 ϕ 45**

bez pojemnika/without bucket

bez wkładki/without adapter

[12] * 2-1,5 ml probówka (10,8x41,8 mm), Eppendorf®; [15011], 2 ml (10,8x41,8 mm); [15128], 1,5ml (10,8x40,5 mm)
2-1,5 ml tube (10,8x41,8 mm), Eppendorf®; [15011], 2 ml (10,8x41,8 mm); [15128], 1,5ml (10,8x40,5 mm)

14084

[12] 15127 0,5 ml probówka PCR (7,8 x 31 mm)
0,5 ml PCR tube (7,8 x 31 mm)

14126

[12] 15124 0,4 ml probówka PCR (5,7 x 48,6 mm)
0,4 ml PCR tube (5,7 x 48,6 mm)

14133

[12] 15125 0,2 ml probówka PCR (6 x 21,6 mm)
0,2 ml PCR tube (6 x 21,6 mm)**11213****RPM 5000 RCF 3494 Rmax 125 ϕ 30**

13276

14035

[8] 15118 10 ml probówka szklana (16 x 100 mm)
10 ml glass tube (16 x 100 mm)

14036

[8] 15119 7 ml probówka szklana (12 x 100 mm)
7 ml glass tube (12 x 100 mm)

14043

[8] 15120 5 ml probówka szklana (12 x 75 mm)
5 ml glass tube (12 x 75 mm)

14073

[8] 15118 10 ml probówka szklana (16 x 100 mm)
10 ml glass tube (16 x 100 mm)

13276 R max 125 RCF 3494 x g

14035 Rmax 125 RCF 3494

[8] 15046 14 ml probówka z pokrywką (16,8 x 113,7 mm), Sarstedt®
14 ml tube with cap (16,8 x 113,7 mm), Sarstedt®[8] 15048 15 ml Thermo Nalgene® (16 x 113 mm)
15 ml Thermo Nalgene® (16 x 113 mm)[8] 15053 10 ml probówka z pokrywką (16 x 106 mm)
10 ml tube with cap (16 x 106 mm)

14036 Rmax 125 RCF 3494

[8] * BD Vacutainer® (13 x 100 mm), (4-7 ml)

[8] * Greiner Vacuette® (13 x 100 mm), (3,5-6 ml)

[8] 15054 6 ml probówka z pokrywką (11,5 x 92 mm), Sarstedt®
6 ml tube with cap (11,5 x 92 mm), Sarstedt®

14043 Rmax 125 RCF 3494

[8] * Greiner Vacuette® (13 x 75 mm), (1-4,5 ml)

[8] * Sarstedt S-Monovette® (13 x 75 mm), (2,7; 3; 4,3 ml)

[8] * Sarstedt S-Monovette® (13 x 90 mm), (4,9; 5,6 ml)

[8] 15419 5 ml probówka z korkiem (12 x 85 mm), Sarstedt®
5 ml tube with cap (12 x 85 mm), Sarstedt®

14071 Rmax 125 RCF 3494

[8] * 28 ml Thermo Nalgene® Oak Ridge (25,4 x 101,8 mm)

[8] 15055 30 ml probówka z pokrywką (25,4 x 103,2 mm)
30 ml tube with cap (25,4 x 103,2 mm)

A. Wyposażenie dodatkowe/Optional accessories
MPW M-UNIVERSAL

[8]	15056	30 ml Thermo Nalgene® Oak Ridge (25,5 x 94,3 mm) 30 ml Thermo Nalgene® Oak Ridge (25,5 x 94,3 mm)			
[8]	15424	30 ml probówka z pokrywką (25,5 x 94 mm), Nalgene® 30 ml tube with cap (25,5 x 94 mm), Nalgene®			
		14073 Rmax 125 RCF 3494			
[8]	*	BD Vacutainer® (16 x 100 mm), (2,5-11 ml)			
[8]	*	Greiner Vacuette® (16 x 100 mm), (7-9 ml)			
[8]	*	Sarstedt S-Monovette® (15 x 92 mm), (7,5; 8,2; 8,5 ml)			
[8]	*	Sarstedt S-Monovette® (16 x 92 mm), (9; 10 ml)			
[8]	15046	14 ml probówka z pokrywką (16,8 x 113,7 mm), Sarstedt® 14 ml tube with cap (16,8 x 113,7 mm), Sarstedt®			
[8]	15053	10 ml probówka z pokrywką (16 x 106 mm) 10 ml tube with cap (16 x 106 mm)			
		14089 Rmax 125 RCF 3494			
[8]	*	15 ml probówka z dnem stożkowym z zakrętką (17 x 120 mm), Falcon®; [15050], 15ml (17 x 120 mm) 15 ml tube, conical bottom, with cap (17 x 120 mm), Falcon®; [15050] 15ml Sarstedt®(17 x 120 mm)			
		14248 Rmax 125 RCF 3494			
[8]	15055	30 ml probówka z pokrywką (25,4 x 103,2 mm) 30 ml tube with cap (25,4 x 103,2 mm)			
		bez wkładki/without adapter Rmax 125 RCF 3494			
[8]	15051	50 ml Thermo Nalgene® Oak Ridge (28,8 x 106,7 mm) 50 ml Thermo Nalgene® Oak Ridge (28,8 x 106,7 mm)			
[8]	*	50 ml probówka z dnem stożkowym z zakrętką (30 x 117 mm), Falcon®; [15052] 50ml (30 x 117mm) 50 ml tube, conical bottom, with cap (30 x 117 mm), Falcon®; [15052] 50ml Sarstedt® (30 x 117 mm)			
[8]	*	50 ml probówka z dnem stożkowym bez rantu (30 x 115 mm), Greiner® 50 ml tube, conical bottom, without skirt (30 x 115 mm), Greiner®			
[8]	*	50 ml probówka Advanced Oak Ridge (29x102 mm), Herolab® nr 25 32 11 50 ml tube, Advanced Oak Ridge (29 x 102 mm), Herolab® no. 25 32 11			
		14089+14868 Rmax 125 RCF 3494			
[8]	*	5 ml probówka z korkiem wciskany (17 x 54,2 mm), Eppendorf® 5 ml tube with snap cap (17 x 54,2 mm), Eppendorf®			
[8]	*	5 ml probówka z korkiem zakręcany (17 x 66 mm), Eppendorf® 5 ml tube with screw cap (17 x 66 mm), Eppendorf®			
		13278+17151			
		14035			
[8]	15118	10 ml probówka szklana (16 x 100 mm) 10 ml glass tube (16 x 100 mm)			
		14036			
[8]	15119	7 ml probówka szklana (12 x 100 mm) 7 ml glass tube (12 x 100 mm)			
		14043			
[8]	15120	5 ml probówka szklana (12 x 75 mm) 5 ml glass tube (12 x 75 mm)			
		14073			
[8]	15118	10 ml probówka szklana (16 x 100 mm) 10 ml glass tube (16 x 100 mm)			
		13278+17151 R max 125 RCF 3494 x g			
		14035 Rmax 125 RCF 3494			
[8]	15046	14 ml probówka z pokrywką (16,8 x 113,7 mm), Sarstedt® 14 ml tube with cap (16,8 x 113,7 mm), Sarstedt®			
[8]	15048	15 ml Thermo Nalgene® (16 x 113 mm) 15 ml Thermo Nalgene® (16 x 113 mm)			
[8]	15053	10 ml probówka z pokrywką (16 x 106 mm) 10 ml tube with cap (16 x 106 mm)			
		14036 Rmax 125 RCF 3494			
[8]	15054	6 ml probówka z pokrywką (11,5 x 92 mm), Sarstedt® 6 ml tube with cap (11,5 x 92 mm), Sarstedt®			
		14043 Rmax 125 RCF 3494			
[8]	*	Greiner Vacuette® (13 x 75 mm), (1-4,5 ml)			
[8]	15419	5 ml probówka z korkiem (12 x 85 mm), Sarstedt® 5 ml tube with cap (12 x 85 mm), Sarstedt®			
		14071 Rmax 125 RCF 3494			
[8]	*	28 ml Thermo Nalgene® Oak Ridge (25,4 x 101,8 mm)			
[8]	15055	30 ml probówka z pokrywką (25,4 x 103,2 mm) 30 ml tube with cap (25,4 x 103,2 mm)			
[8]	15056	30 ml Thermo Nalgene® Oak Ridge (25,5 x 94,3 mm) 30 ml Thermo Nalgene® Oak Ridge (25,5 x 94,3 mm)			
[8]	15424	30 ml probówka z pokrywką (25,5 x 94 mm), Nalgene® 30 ml tube with cap (25,5 x 94 mm), Nalgene®			

A. Wyposażenie dodatkowe/Optional accessories	
MPW M-UNIVERSAL	
14073 Rmax 125 RCF 3494	
[8]	* BD Vacutainer® (16 x 100 mm), (2,5-11 ml)
[8]	* Greiner Vacuette® (16 x 100 mm), (7-9 ml)
[8]	* Sarstedt S-Monovette® (15 x 92 mm), (7,5; 8,2; 8,5 ml)
[8]	* Sarstedt S-Monovette® (16 x 92 mm), (9; 10 ml)
[8]	15046 14 ml probówka z pokrywką (16,8 x 113,7 mm), Sarstedt® 14 ml tube with cap (16,8 x 113,7 mm), Sarstedt®
[8]	15053 10 ml probówka z pokrywką (16 x 106 mm) 10 ml tube with cap (16 x 106 mm)
14089 Rmax 125 RCF 3494	
[8]	* 15 ml probówka z dnem stożkowym z zakrętką (17 x 120 mm), Falcon®; [15050], 15ml (17 x 120 mm) 15 ml tube, conical bottom, with cap (17 x 120 mm), Falcon®; [15050] 15ml Sarstedt®(17 x 120 mm)
14248 Rmax 125 RCF 3494	
[8]	15055 30 ml probówka z pokrywką (25,4 x 103,2 mm) 30 ml tube with cap (25,4 x 103,2 mm)
bez wkładki/without adapter Rmax 125 RCF 3494	
[8]	15051 50 ml Thermo Nalgene® Oak Ridge (28,8 x 106,7 mm) 50 ml Thermo Nalgene® Oak Ridge (28,8 x 106,7 mm)
[8]	* 50 ml probówka z dnem stożkowym z zakrętką (30 x 117 mm), Falcon®; [15052] 50ml (30 x 117mm) 50 ml tube, conical bottom, with cap (30 x 117 mm), Falcon®; [15052] 50ml Sarstedt® (30 x 117 mm)
[8]	* 50 ml probówka z dnem stożkowym bez rantu (30 x 115 mm), Greiner® 50 ml tube, conical bottom, without skirt (30 x 115 mm), Greiner®
[8]	* 50 ml probówka Advanced Oak Ridge (29x102 mm), Herolab® nr 25 32 11 50 ml tube, Advanced Oak Ridge (29 x 102 mm), Herolab® no. 25 32 11
14089+14868 Rmax 125 RCF 3494	
[8]	* 5 ml probówka z korkiem wciskany (17 x 54,2 mm), Eppendorf® 5 ml tube with snap cap (17 x 54,2 mm), Eppendorf®
11216	
RPM 14000 RCF 19064 Rmax 87 ± 45	
bez pojemnika/without bucket	
bez wkładki/without adapter	
[12]	15419 5 ml probówka z korkiem (12 x 85 mm), Sarstedt® 5 ml tube with cap (12 x 85 mm), Sarstedt®
11217	
RPM 6000 RCF 4226 Rmax 105 ± 30	
13080	
14082	
[10]	* BD Vacutainer® (13 x 100 mm), (4-7 ml)
[10]	* Greiner Vacuette® (13 x 100 mm), (3,5-6 ml)
[10]	* Sarstedt S-Monovette® (11 x 92 mm), (4,5; 5 ml)
[10]	15054 6 ml probówka z pokrywką (11,5 x 92 mm), Sarstedt® 6 ml tube with cap (11,5 x 92 mm), Sarstedt®
[10]	15119 7 ml probówka szklana (12 x 100 mm) 7 ml glass tube (12 x 100 mm)
bez wkładki/without adapter	
[10]	* Greiner Vacuette® (16 x 100 mm), (7-9 ml)
[10]	* Sarstedt S-Monovette® (15 x 92 mm), (7,5; 8,2; 8,5 ml)
[10]	* BD Vacutainer® (16 x 100 mm), (2,5-11 ml)
[10]	* Sarstedt S-Monovette® (16 x 92 mm), (9; 10 ml)
[10]	15046 14 ml probówka z pokrywką (16,8 x 113,7 mm), Sarstedt® 14 ml tube with cap (16,8 x 113,7 mm), Sarstedt®
[10]	15048 15 ml Thermo Nalgene® (16 x 113 mm) 15 ml Thermo Nalgene® (16 x 113 mm)
[10]	15053 10 ml probówka z pokrywką (16 x 106 mm) 10 ml tube with cap (16 x 106 mm)
[10]	15118 10 ml probówka szklana (16 x 100 mm) 10 ml glass tube (16 x 100 mm)
[10]	* 15 ml probówka z dnem stożkowym z zakrętką (17 x 120 mm), Falcon®; [15050], 15ml (17 x 120 mm) 15 ml tube, conical bottom, with cap (17 x 120 mm), Falcon®; [15050] 15ml Sarstedt®(17 x 120 mm)
11217	
RPM 6000 RCF 3502 Rmax 87 ± 30	
13080	
14082+14815	
[10]	15120 5 ml probówka szklana (12 x 75 mm) 5 ml glass tube (12 x 75 mm)

A. Wyposażenie dodatkowe/Optional accessories			
MPW M-UNIVERSAL			
14082+14815 Rmax 87 RCF 3502			
[10]	*	Greiner Vacuette® (13 x 75 mm), (1-4,5 ml)	
[10]	*	Sarstedt S-Monovette® (13 x 75 mm), (2,7; 3; 4,3 ml)	
[10]	*	BD Vacutainer® (13 x 75 mm), (1,6-5,3 ml)	
[10]	*	Sarstedt S-Monovette® (11 x 66 mm), (1,6; 2; 2,7; 3; 3,1 ml)	
[10]	*	Sarstedt S-Monovette® (13 x 65 mm), (2,6; 2,9; 3,4; 3,8 ml)	
14815 Rmax 87 RCF 3502			
[10]	*	Sarstedt S-Monovette® (15 x 75 mm), (4; 4,3; 5,5 ml)	
[10]	*	10 ml Thermo Nalgene® Oak Ridge (16 x 81,5 mm)	
[10]	15121	10 ml probówka z dnem okrągłym i pokrywką (17 x 70 mm) 10 ml tube, round bottom, with cap (17 x 70 mm)	
11461			
RPM 15100 RCF 21158 Rmax 83 \neq 45			
bez pojemnika/without bucket R max 83 RCF 21158 x g			
14084 Rmax 83 RCF 21158			
[24]	15127	0,5 ml probówka PCR (7,8 x 31 mm) 0,5 ml PCR tube (7,8 x 31 mm)	
14126 Rmax 83 RCF 21158			
[24]	15124	0,4 ml probówka PCR (5,7 x 48,6 mm) 0,4 ml PCR tube (5,7 x 48,6 mm)	
14133 Rmax 83 RCF 21158			
[24]	15125	0,2 ml probówka PCR (6 x 21,6 mm) 0,2 ml PCR tube (6 x 21,6 mm)	
bez wkładki/without adapter Rmax 83 RCF 21158			
[24]	*	2-1,5 ml probówka (10,8x41,8 mm), Eppendorf®; [15011], 2 ml (10,8x41,8 mm); [15128], 1,5ml (10,8x40,5 mm) 2-1,5 ml tube (10,8x41,8 mm), Eppendorf®; [15011], 2 ml (10,8x41,8 mm); [15128], 1,5ml (10,8x40,5 mm)	
11462			
RPM 14000 RCF 18188 Rmax 83 \neq 45			
bez pojemnika/without bucket R max 83 RCF 18188 x g			
14084 Rmax 83 RCF 18188			
[36]	15127	0,5 ml probówka PCR (7,8 x 31 mm) 0,5 ml PCR tube (7,8 x 31 mm)	
14126 Rmax 83 RCF 18188			
[36]	15124	0,4 ml probówka PCR (5,7 x 48,6 mm) 0,4 ml PCR tube (5,7 x 48,6 mm)	
14133 Rmax 83 RCF 18188			
[36]	15125	0,2 ml probówka PCR (6 x 21,6 mm) 0,2 ml PCR tube (6 x 21,6 mm)	
bez wkładki/without adapter Rmax 83 RCF 18188			
[36]	*	2-1,5 ml probówka (10,8x41,8 mm), Eppendorf®; [15011], 2 ml (10,8x41,8 mm); [15128], 1,5ml (10,8x40,5 mm) 2-1,5 ml tube (10,8x41,8 mm), Eppendorf®; [15011], 2 ml (10,8x41,8 mm); [15128], 1,5ml (10,8x40,5 mm)	
11501			
RPM 4500 RCF 2717 Rmax 120 \neq 30			
13080			
14082+14815 Rmax 120 RCF 2717			
[30]	*	BD Vacutainer® (13 x 75 mm), (1,6-5,3 ml)	
[30]	*	Greiner Vacuette® (13 x 75 mm), (1-4,5 ml)	
[30]	*	Sarstedt S-Monovette® (11 x 66 mm), (1,6; 2; 2,7; 3; 3,1 ml)	
[30]	*	Sarstedt S-Monovette® (13 x 65 mm), (2,6; 2,9; 3,4; 3,8 ml)	
[30]	*	Sarstedt S-Monovette® (13 x 75 mm), (2,7; 3; 4,3 ml)	
[30]	15120	5 ml probówka szklana (12 x 75 mm) 5 ml glass tube (12 x 75 mm)	
14815 Rmax 120 RCF 2717			
[30]	*	Sarstedt S-Monovette® (15 x 75 mm), (4; 4,3; 5,5 ml)	
[30]	*	10 ml Thermo Nalgene® Oak Ridge (16 x 81,5 mm)	
[30]	15121	10 ml probówka z dnem okrągłym i pokrywką (17 x 70 mm) 10 ml tube, round bottom, with cap (17 x 70 mm)	
11715			
RPM 14000 RCF 15558 Rmax 71 \neq 30			
bez pojemnika/without bucket			
bez wkładki/without adapter			

A. Wyposażenie dodatkowe/Optional accessories	
MPW M-UNIVERSAL	
[10]	15121 10 ml probówka z dnem okrągłym i pokrywką (17 x 70 mm) 10 ml tube, round bottom, with cap (17 x 70 mm)
11716	
RPM 14000 RCF 15339 Rmax 70 \pm 45	
bez pojemnika/without bucket R max 70 RCF 15339 x g	
bez wkładki/without adapter Rmax 70 RCF 15339	
[4]	15131 4 x 0,2 ml probówki szeregowo PCR-strip (10,2 x 37,2 mm) 4 x 0,2 ml PCR strip (10,2 x 37,2 mm)
[4]	15122 8 x 0,2 ml probówki szeregowo PCR-strip (10,2 x 72,4 mm) 8 x 0,2 ml PCR strip (10,2 x 72,4 mm)
[32]	15125 0,2 ml probówka PCR (6 x 21,6 mm) 0,2 ml PCR tube (6 x 21,6 mm)
[4]	15130 8 x 0,2 ml probówki szeregowo PCR strip (7,3 x 77,2 mm) 8 x 0,2 ml PCR strip (7,3 x 77,2 mm)
11718	
RPM 6300 RCF 5014 Rmax 113 \pm 30	
13719	
14024	
[4]	* 15 ml probówka z dnem stożkowym z zakrętką (17 x 120 mm), Falcon®; [15050], 15ml (17 x 120 mm) 15 ml tube, conical bottom, with cap (17 x 120 mm), Falcon®; [15050] 15ml Sarstedt®(17 x 120 mm)
14196	
[4]	15040 100 ml probówka z pokrywką (45,2 x 103,7 mm) 100 ml tube with cap (45,2 x 103,7 mm)
14224	
[4]	15056 30 ml Thermo Nalgene® Oak Ridge (25,5 x 94,3 mm) 30 ml Thermo Nalgene® Oak Ridge (25,5 x 94,3 mm)
[4]	15055 30 ml probówka z pokrywką (25,4 x 103,2 mm) 30 ml tube with cap (25,4 x 103,2 mm)
[4]	15222 30 ml probówka z pokrywką (25 x 94mm), Sterilin® 30 ml tube with cap (25 x 94 mm), Sterilin®
[4]	15223 30 ml probówka z pokrywką (25 x 94 mm), Sterilin® 30 ml tube with cap (25 x 94 mm), Sterilin®
14226	
[4]	* 50 ml probówka z dnem stożkowym z rantem (30 x 115 mm), Greiner® 50 ml tube, conical bottom, skirted (30 x 115 mm), Greiner®
14189+14188	
[4]	15051 50 ml Thermo Nalgene® Oak Ridge (28,8 x 106,7 mm) 50 ml Thermo Nalgene® Oak Ridge (28,8 x 106,7 mm)
[4]	* 50 ml probówka z dnem stożkowym z zakrętką (30 x 117 mm), Falcon®; [15052] 50ml (30 x 117mm) 50 ml tube, conical bottom, with cap (30 x 117 mm), Falcon®; [15052] 50ml Sarstedt® (30 x 117 mm)
[4]	* 50 ml probówka z dnem stożkowym bez rantu (30 x 115 mm), Greiner® 50 ml tube, conical bottom, without skirt (30 x 115 mm), Greiner®
[4]	* 50 ml probówka Advanced Oak Ridge (29x102 mm), Herolab® nr 25 32 11 50 ml tube, Advanced Oak Ridge (29 x 102 mm), Herolab® no. 25 32 11
14190+14188	
[4]	15055 30 ml probówka z pokrywką (25,4 x 103,2 mm) 30 ml tube with cap (25,4 x 103,2 mm)
11740	
RPM 5500 RCF 4058 Rmax 120 \pm 30	
13080	
14082	
[12]	* BD Vacutainer® (13 x 100 mm), (4-7 ml)
[12]	* Greiner Vacuette® (13 x 100 mm), (3,5-6 ml)
[12]	* Sarstedt S-Monovette® (11 x 92 mm), (4,5; 5 ml)
[12]	15054 6 ml probówka z pokrywką (11,5 x 92 mm), Sarstedt® 6 ml tube with cap (11,5 x 92 mm), Sarstedt®
[12]	15119 7 ml probówka szklana (12 x 100 mm) 7 ml glass tube (12 x 100 mm)
bez wkładki/without adapter	
[12]	* BD Vacutainer® (16 x 100 mm), (2,5-11 ml)
[12]	* Greiner Vacuette® (16 x 100 mm), (7-9 ml)
[12]	* Sarstedt S-Monovette® (15 x 92 mm), (7,5; 8,2; 8,5 ml)
[12]	* Sarstedt S-Monovette® (16 x 92 mm), (9; 10 ml)
[12]	15046 14 ml probówka z pokrywką (16,8 x 113,7 mm), Sarstedt® 14 ml tube with cap (16,8 x 113,7 mm), Sarstedt®

A. Wyposażenie dodatkowe/Optional accessories**MPW M-UNIVERSAL**

[12]	15048	15 ml Thermo Nalgene® (16 x 113 mm) 15 ml Thermo Nalgene® (16 x 113 mm)
[12]	15053	10 ml probówka z pokrywką (16 x 106 mm) 10 ml tube with cap (16 x 106 mm)
[12]	15118	10 ml probówka szklana (16 x 100 mm) 10 ml glass tube (16 x 100 mm)
[12]	*	15 ml probówka z dnem stożkowym z zakrętką (17 x 120 mm), Falcon®; [15050], 15ml (17 x 120 mm) 15 ml tube, conical bottom, with cap (17 x 120 mm), Falcon®; [15050] 15ml Sarstedt®(17 x 120 mm)

11740**RPM 5500 RCF 3416 Rmax 101 \pm 30**

13080

14082+14815

[12]	15120	5 ml probówka szklana (12 x 75 mm) 5 ml glass tube (12 x 75 mm)
		14082+14815 Rmax 101 RCF 3416
[12]	*	BD Vacutainer® (13 x 75 mm), (1,6-5,3 ml)
[12]	*	Greiner Vacuette® (13 x 75 mm), (1-4,5 ml)
[12]	*	Sarstedt S-Monovette® (11 x 66 mm), (1,6; 2; 2,7; 3; 3,1 ml)
[12]	*	Sarstedt S-Monovette® (13 x 65 mm), (2,6; 2,9; 3,4; 3,8 ml)
[12]	*	Sarstedt S-Monovette® (13 x 75 mm), (2,7; 3; 4,3 ml)
		14815 Rmax 101 RCF 3416
[12]	*	Sarstedt S-Monovette® (15 x 75 mm), (4; 4,3; 5,5 ml)
[12]	*	10 ml Thermo Nalgene® Oak Ridge (16 x 81,5 mm)
[12]	15121	10 ml probówka z dnem okrągłym i pokrywką (17 x 70 mm) 10 ml tube, round bottom, with cap (17 x 70 mm)

11741**RPM 6000 RCF 4226 Rmax 105 \pm 30**

13080

14082

[8]	*	BD Vacutainer® (13 x 100 mm), (4-7 ml)
[8]	*	Greiner Vacuette® (13 x 100 mm), (3,5-6 ml)
[8]	*	Sarstedt S-Monovette® (11 x 92 mm), (4,5; 5 ml)
[8]	15054	6 ml probówka z pokrywką (11,5 x 92 mm), Sarstedt® 6 ml tube with cap (11,5 x 92 mm), Sarstedt®
[8]	15119	7 ml probówka szklana (12 x 100 mm) 7 ml glass tube (12 x 100 mm)
		bez wkładki/without adapter
[8]	*	BD Vacutainer® (16 x 100 mm), (2,5-11 ml)
[8]	*	Greiner Vacuette® (16 x 100 mm), (7-9 ml)
[8]	*	Sarstedt S-Monovette® (15 x 92 mm), (7,5; 8,2; 8,5 ml)
[8]	*	Sarstedt S-Monovette® (16 x 92 mm), (9; 10 ml)
[8]	15046	14 ml probówka z pokrywką (16,8 x 113,7 mm), Sarstedt® 14 ml tube with cap (16,8 x 113,7 mm), Sarstedt®
[8]	15048	15 ml Thermo Nalgene® (16 x 113 mm) 15 ml Thermo Nalgene® (16 x 113 mm)
[8]	15053	10 ml probówka z pokrywką (16 x 106 mm) 10 ml tube with cap (16 x 106 mm)
[8]	15118	10 ml probówka szklana (16 x 100 mm) 10 ml glass tube (16 x 100 mm)
[8]	*	15 ml probówka z dnem stożkowym z zakrętką (17 x 120 mm), Falcon®; [15050], 15ml (17 x 120 mm) 15 ml tube, conical bottom, with cap (17 x 120 mm), Falcon®; [15050] 15ml Sarstedt®(17 x 120 mm)

11741**RPM 6000 RCF 3502 Rmax 87 \pm 30**

13080

14082+14815

[8]	15120	5 ml probówka szklana (12 x 75 mm) 5 ml glass tube (12 x 75 mm)
		14082+14815 Rmax 87 RCF 3502
[8]	*	BD Vacutainer® (13 x 75 mm), (1,6-5,3 ml)
[8]	*	Greiner Vacuette® (13 x 75 mm), (1-4,5 ml)
[8]	*	Sarstedt S-Monovette® (11 x 66 mm), (1,6; 2; 2,7; 3; 3,1 ml)
[8]	*	Sarstedt S-Monovette® (13 x 65 mm), (2,6; 2,9; 3,4; 3,8 ml)
[8]	*	Sarstedt S-Monovette® (13 x 75 mm), (2,7; 3; 4,3 ml)
		14815 Rmax 87 RCF 3502

A. Wyposażenie dodatkowe/Optional accessories**MPW M-UNIVERSAL**

[8]	*	Sarstedt S-Monovette® (15 x 75 mm), (4; 4,3; 5,5 ml)
[8]	*	10 ml Thermo Nalgene® Oak Ridge (16 x 81,5 mm)
[8]	15121	10 ml probówka z dnem okrągłym i pokrywką (17 x 70 mm) 10 ml tube, round bottom, with cap (17 x 70 mm)

11744**RPM 4500 RCF 2830 Rmax 125 \pm 30**

13276

bez wkładki/without adapter

[10]	15051	50 ml Thermo Nalgene® Oak Ridge (28,8 x 106,7 mm) 50 ml Thermo Nalgene® Oak Ridge (28,8 x 106,7 mm)
[10]	*	50 ml probówka z dnem stożkowym z zakrętką (30 x 117 mm), Falcon®; [15052] 50ml (30 x 117mm) 50 ml tube, conical bottom, with cap (30 x 117 mm), Falcon®; [15052] 50ml Sarstedt® (30 x 117 mm)
[10]	*	50 ml probówka z dnem stożkowym bez rantu (30 x 115 mm), Greiner® 50 ml tube, conical bottom, without skirt (30 x 115 mm), Greiner®
[10]	*	50 ml probówka Advanced Oak Ridge (29x102 mm), Herolab® nr 25 32 11 50 ml tube, Advanced Oak Ridge (29 x 102 mm), Herolab® no. 25 32 11

14035

[10]	15046	14 ml probówka z pokrywką (16,8 x 113,7 mm), Sarstedt® 14 ml tube with cap (16,8 x 113,7 mm), Sarstedt®
[10]	15048	15 ml Thermo Nalgene® (16 x 113 mm) 15 ml Thermo Nalgene® (16 x 113 mm)
[10]	15053	10 ml probówka z pokrywką (16 x 106 mm) 10 ml tube with cap (16 x 106 mm)
[10]	15118	10 ml probówka szklana (16 x 100 mm) 10 ml glass tube (16 x 100 mm)

14036

[10]	*	BD Vacutainer® (13 x 100 mm), (4-7 ml)
[10]	*	Greiner Vacuette® (13 x 100 mm), (3,5-6 ml)
[10]	15054	6 ml probówka z pokrywką (11,5 x 92 mm), Sarstedt® 6 ml tube with cap (11,5 x 92 mm), Sarstedt®
[10]	15119	7 ml probówka szklana (12 x 100 mm) 7 ml glass tube (12 x 100 mm)

14043

[10]	*	Greiner Vacuette® (13 x 75 mm), (1-4,5 ml)
[10]	*	Sarstedt S-Monovette® (13 x 75 mm), (2,7; 3; 4,3 ml)
[10]	*	Sarstedt S-Monovette® (13 x 90 mm), (4,9; 5,6 ml)
[10]	15120	5 ml probówka szklana (12 x 75 mm) 5 ml glass tube (12 x 75 mm)
[10]	15419	5 ml probówka z korkiem (12 x 85 mm), Sarstedt® 5 ml tube with cap (12 x 85 mm), Sarstedt®

14071

[10]	*	28 ml Thermo Nalgene® Oak Ridge (25,4 x 101,8 mm)
[10]	15055	30 ml probówka z pokrywką (25,4 x 103,2 mm) 30 ml tube with cap (25,4 x 103,2 mm)
[10]	15056	30 ml Thermo Nalgene® Oak Ridge (25,5 x 94,3 mm) 30 ml Thermo Nalgene® Oak Ridge (25,5 x 94,3 mm)
[10]	15424	30 ml probówka z pokrywką (25,5 x 94 mm), Nalgene® 30 ml tube with cap (25,5 x 94 mm), Nalgene®

14073

[10]	*	Greiner Vacuette® (16 x 100 mm), (7-9 ml)
[10]	*	Sarstedt S-Monovette® (15 x 92 mm), (7,5; 8,2; 8,5 ml)
[10]	*	BD Vacutainer® (16 x 100 mm), (2,5-11 ml)
[10]	*	Sarstedt S-Monovette® (16 x 92 mm), (9; 10 ml)
[10]	15046	14 ml probówka z pokrywką (16,8 x 113,7 mm), Sarstedt® 14 ml tube with cap (16,8 x 113,7 mm), Sarstedt®
[10]	15048	15 ml Thermo Nalgene® (16 x 113 mm) 15 ml Thermo Nalgene® (16 x 113 mm)
[10]	15053	10 ml probówka z pokrywką (16 x 106 mm) 10 ml tube with cap (16 x 106 mm)
[10]	15118	10 ml probówka szklana (16 x 100 mm) 10 ml glass tube (16 x 100 mm)

14089

[10]	*	15 ml probówka z dnem stożkowym z zakrętką (17 x 120 mm), Falcon®; [15050], 15ml (17 x 120 mm) 15 ml tube, conical bottom, with cap (17 x 120 mm), Falcon®; [15050] 15ml Sarstedt®(17 x 120 mm)
------	---	--

14248

[10]	15055	30 ml probówka z pokrywką (25,4 x 103,2 mm) 30 ml tube with cap (25,4 x 103,2 mm)
------	-------	--

14089+14868

A. Wyposażenie dodatkowe/Optional accessories	
MPW M-UNIVERSAL	
[10]	* 5 ml probówka z korkiem wciskany (17 x 54,2 mm), Eppendorf® 5 ml tube with snap cap (17 x 54,2 mm), Eppendorf®
[10]	* 5 ml probówka z korkiem zakręcany (17 x 66 mm), Eppendorf® 5 ml tube with screw cap (17 x 66 mm), Eppendorf®
11745	
RPM 5000 RCF 3354 Rmax 120 α 30	
13080	
14082	
[24]	* BD Vacutainer® (13 x 100 mm), (4-7 ml)
[24]	* Greiner Vacuette® (13 x 100 mm), (3,5-6 ml)
[24]	* Sarstedt S-Monovette® (11 x 92 mm), (4,5; 5 ml)
[24]	15054 6 ml probówka z pokrywką (11,5 x 92 mm), Sarstedt® 6 ml tube with cap (11,5 x 92 mm), Sarstedt®
[24]	15119 7 ml probówka szklana (12 x 100 mm) 7 ml glass tube (12 x 100 mm)
bez wkładki/without adapter	
[24]	* BD Vacutainer® (16 x 100 mm), (2,5-11 ml)
[24]	* Greiner Vacuette® (16 x 100 mm), (7-9 ml)
[24]	* Sarstedt S-Monovette® (15 x 92 mm), (7,5; 8,2; 8,5 ml)
[24]	* Sarstedt S-Monovette® (16 x 92 mm), (9; 10 ml)
[24]	15046 14 ml probówka z pokrywką (16,8 x 113,7 mm), Sarstedt® 14 ml tube with cap (16,8 x 113,7 mm), Sarstedt®
[24]	15048 15 ml Thermo Nalgene® (16 x 113 mm) 15 ml Thermo Nalgene® (16 x 113 mm)
[24]	15053 10 ml probówka z pokrywką (16 x 106 mm) 10 ml tube with cap (16 x 106 mm)
[24]	15118 10 ml probówka szklana (16 x 100 mm) 10 ml glass tube (16 x 100 mm)
[24]	* 15 ml probówka z dnem stożkowym z zakrętką (17 x 120 mm), Falcon®; [15050], 15ml (17 x 120 mm) 15 ml tube, conical bottom, with cap (17 x 120 mm), Falcon®; [15050] 15ml Sarstedt®(17 x 120 mm)
11745	
RPM 5000 RCF 2935 Rmax 105 α 30	
13080	
14082+14815 Rmax 105 RCF 2935	
[24]	* BD Vacutainer® (13 x 75 mm), (1,6-5,3 ml)
[24]	* Greiner Vacuette® (13 x 75 mm), (1-4,5 ml)
[24]	* Sarstedt S-Monovette® (11 x 66 mm), (1,6; 2; 2,7; 3; 3,1 ml)
[24]	* Sarstedt S-Monovette® (13 x 65 mm), (2,6; 2,9; 3,4; 3,8 ml)
[24]	* Sarstedt S-Monovette® (13 x 75 mm), (2,7; 3; 4,3 ml)
[24]	15120 5 ml probówka szklana (12 x 75 mm) 5 ml glass tube (12 x 75 mm)
14815 Rmax 105 RCF 2935	
[24]	* Sarstedt S-Monovette® (15 x 75 mm), (4; 4,3; 5,5 ml)
[24]	* 10 ml Thermo Nalgene® Oak Ridge (16 x 81,5 mm)
[24]	15121 10 ml probówka z dnem okrągłym i pokrywką (17 x 70 mm) 10 ml tube, round bottom, with cap (17 x 70 mm)
11746	
RPM 6000 RCF 4427 Rmax 110 α 30	
13276	
bez wkładki/without adapter	
[6]	* 50 ml probówka z dnem stożkowym z zakrętką (30 x 117 mm), Falcon®; [15052] 50ml (30 x 117mm) 50 ml tube, conical bottom, with cap (30 x 117 mm), Falcon®; [15052] 50ml Sarstedt® (30 x 117 mm)
[6]	* 50 ml probówka z dnem stożkowym bez rantu (30 x 115 mm), Greiner® 50 ml tube, conical bottom, without skirt (30 x 115 mm), Greiner®
[6]	15051 50 ml Thermo Nalgene® Oak Ridge (28,8 x 106,7 mm) 50 ml Thermo Nalgene® Oak Ridge (28,8 x 106,7 mm)
[6]	* 50 ml probówka Advanced Oak Ridge (29x102 mm), Herolab® nr 25 32 11 50 ml tube, Advanced Oak Ridge (29 x 102 mm), Herolab® no. 25 32 11
14035	
[6]	15046 14 ml probówka z pokrywką (16,8 x 113,7 mm), Sarstedt® 14 ml tube with cap (16,8 x 113,7 mm), Sarstedt®
[6]	15048 15 ml Thermo Nalgene® (16 x 113 mm) 15 ml Thermo Nalgene® (16 x 113 mm)
[6]	15053 10 ml probówka z pokrywką (16 x 106 mm) 10 ml tube with cap (16 x 106 mm)

* probówka niedostępna w ofercie MPW lub dostępny odpowiednik (np:[15050]), patrz kolumna z prawej
tube is not offered by MPW or equivalent is available (e.g. [15050]), see column on the right

A. Wyposażenie dodatkowe/Optional accessories**MPW M-UNIVERSAL**

[6]	15118	10 ml probówka szklana (16 x 100 mm) 10 ml glass tube (16 x 100 mm)
14036		
[6]	*	BD Vacutainer® (13 x 100 mm), (4-7 ml)
[6]	*	Greiner Vacuette® (13 x 100 mm), (3,5-6 ml)
[6]	15054	6 ml probówka z pokrywką (11,5 x 92 mm), Sarstedt® 6 ml tube with cap (11,5 x 92 mm), Sarstedt®
[6]	15119	7 ml probówka szklana (12 x 100 mm) 7 ml glass tube (12 x 100 mm)
14043		
[6]	*	Greiner Vacuette® (13 x 75 mm), (1-4,5 ml)
[6]	*	Sarstedt S-Monovette® (13 x 75 mm), (2,7; 3; 4,3 ml)
[6]	*	Sarstedt S-Monovette® (13 x 90 mm), (4,9; 5,6 ml)
[6]	15120	5 ml probówka szklana (12 x 75 mm) 5 ml glass tube (12 x 75 mm)
[6]	15419	5 ml probówka z korkiem (12 x 85 mm), Sarstedt® 5 ml tube with cap (12 x 85 mm), Sarstedt®
14071		
[6]	*	28 ml Thermo Nalgene® Oak Ridge (25,4 x 101,8 mm)
[6]	15055	30 ml probówka z pokrywką (25,4 x 103,2 mm) 30 ml tube with cap (25,4 x 103,2 mm)
[6]	15056	30 ml Thermo Nalgene® Oak Ridge (25,5 x 94,3 mm) 30 ml Thermo Nalgene® Oak Ridge (25,5 x 94,3 mm)
[6]	15424	30 ml probówka z pokrywką (25,5 x 94 mm), Nalgene® 30 ml tube with cap (25,5 x 94 mm), Nalgene®
14073		
[6]	*	BD Vacutainer® (16 x 100 mm), (2,5-11 ml)
[6]	*	Greiner Vacuette® (16 x 100 mm), (7-9 ml)
[6]	*	Sarstedt S-Monovette® (15 x 92 mm), (7,5; 8,2; 8,5 ml)
[6]	*	Sarstedt S-Monovette® (16 x 92 mm), (9; 10 ml)
[6]	15046	14 ml probówka z pokrywką (16,8 x 113,7 mm), Sarstedt® 14 ml tube with cap (16,8 x 113,7 mm), Sarstedt®
[6]	15053	10 ml probówka z pokrywką (16 x 106 mm) 10 ml tube with cap (16 x 106 mm)
[6]	15118	10 ml probówka szklana (16 x 100 mm) 10 ml glass tube (16 x 100 mm)
14089		
[6]	*	15 ml probówka z dnem stożkowym z zakrętką (17 x 120 mm), Falcon®; [15050], 15ml (17 x 120 mm) 15 ml tube, conical bottom, with cap (17 x 120 mm), Falcon®; [15050] 15ml Sarstedt®(17 x 120 mm)
14248		
[6]	15055	30 ml probówka z pokrywką (25,4 x 103,2 mm) 30 ml tube with cap (25,4 x 103,2 mm)
14089+14868		
[6]	*	5 ml probówka z korkiem wciskany (17 x 54,2 mm), Eppendorf® 5 ml tube with snap cap (17 x 54,2 mm), Eppendorf®
[6]	*	5 ml probówka z korkiem zakręcany (17 x 66 mm), Eppendorf® 5 ml tube with screw cap (17 x 66 mm), Eppendorf®

11760**RPM 14600 RCF 20257 Rmax 85 ϕ 45**

bez pojemnika/without bucket R max 85 RCF 20257 x g

14084 Rmax 85 RCF 20257		
[24]	15127	0,5 ml probówka PCR (7,8 x 31 mm) 0,5 ml PCR tube (7,8 x 31 mm)
14126 Rmax 85 RCF 20257		
[24]	15124	0,4 ml probówka PCR (5,7 x 48,6 mm) 0,4 ml PCR tube (5,7 x 48,6 mm)
14133 Rmax 85 RCF 20257		
[24]	15125	0,2 ml probówka PCR (6 x 21,6 mm) 0,2 ml PCR tube (6 x 21,6 mm)
bez wkładki/without adapter Rmax 85 RCF 20257		
[24]	*	2-1,5 ml probówka (10,8x41,8 mm), Eppendorf®; [15011], 2 ml (10,8x41,8 mm); [15128], 1,5ml (10,8x40,5 mm) 2-1,5 ml tube (10,8x41,8 mm), Eppendorf®; [15011], 2 ml (10,8x41,8 mm); [15128], 1,5ml (10,8x40,5 mm)
[24]	*	2 ml probówki z filtrem - spin columns (10,8 x 46 mm) 2 ml spin columns (with filter) (10,8 x 46 mm); [15011], 2 ml (10,8x41,8 mm); [15128], 1,5ml (10,8x40,5 mm)

11943**RPM 12000 RCF 13684 Rmax 85 ϕ 45**

bez pojemnika/without bucket R max 85 RCF 13684 x g

A. Wyposażenie dodatkowe/Optional accessories			
MPW M-UNIVERSAL			
bez wkładki/without adapter Rmax 85 RCF 13684			
[20]	*	1,6 ml probówka Cryo (12,3 x 46,5 mm) 1,6 ml Cryo tube (12,3 x 46,5 mm)	
[20]	*	1,8 ml probówka Cryo (12,3 x 46,5 mm) 1,8 ml Cryo tube (12,3 x 46,5 mm)	
11944			
RPM 12000 RCF 13684 Rmax 85 \pm 45			
bez pojemnika/without bucket R max 85 RCF 13684 x g			
bez wkładki/without adapter Rmax 85 RCF 13684			
[6]	*	5 ml probówka z korkiem zakręcany (17 x 66 mm), Eppendorf® 5 ml tube with screw cap (17 x 66 mm), Eppendorf®	
[12]	*	5 ml probówka z korkiem wciskany (17 x 54,2 mm), Eppendorf® 5 ml tube with snap cap (17 x 54,2 mm), Eppendorf®	
12193			
RPM 4000 RCF 2504 Rmax 140 \pm 90			
13080			
14082			
[8]	*	BD Vacutainer® (13 x 100 mm), (4-7 ml)	
[8]	*	Greiner Vacuette® (13 x 100 mm), (3,5-6 ml)	
[8]	*	Sarstedt S-Monovette® (11 x 92 mm), (4,5; 5 ml)	
[8]	15054	6 ml probówka z pokrywką (11,5 x 92 mm), Sarstedt® 6 ml tube with cap (11,5 x 92 mm), Sarstedt®	
[8]	15119	7 ml probówka szklana (12 x 100 mm) 7 ml glass tube (12 x 100 mm)	
bez wkładki/without adapter			
[8]	*	BD Vacutainer® (16 x 100 mm), (2,5-11 ml)	
[8]	*	Greiner Vacuette® (16 x 100 mm), (7-9 ml)	
[8]	*	Sarstedt S-Monovette® (15 x 92 mm), (7,5; 8,2; 8,5 ml)	
[8]	*	Sarstedt S-Monovette® (16 x 92 mm), (9; 10 ml)	
[8]	15046	14 ml probówka z pokrywką (16,8 x 113,7 mm), Sarstedt® 14 ml tube with cap (16,8 x 113,7 mm), Sarstedt®	
[8]	15048	15 ml Thermo Nalgene® (16 x 113 mm) 15 ml Thermo Nalgene® (16 x 113 mm)	
[8]	15053	10 ml probówka z pokrywką (16 x 106 mm) 10 ml tube with cap (16 x 106 mm)	
[8]	15118	10 ml probówka szklana (16 x 100 mm) 10 ml glass tube (16 x 100 mm)	
[8]	*	15 ml probówka z dnem stożkowym z zakrętką (17 x 120 mm), Falcon®; [15050], 15ml (17 x 120 mm) 15 ml tube, conical bottom, with cap (17 x 120 mm), Falcon®; [15050] 15ml Sarstedt®(17 x 120 mm)	
12193			
RPM 4000 RCF 1968 Rmax 110 \pm 90			
13080			
14082+14815 Rmax 110 RCF 1968			
[8]	*	BD Vacutainer® (13 x 75 mm), (1,6-5,3 ml)	
[8]	*	Greiner Vacuette® (13 x 75 mm), (1-4,5 ml)	
[8]	*	Sarstedt S-Monovette® (11 x 66 mm), (1,6; 2; 2,7; 3; 3,1 ml)	
[8]	*	Sarstedt S-Monovette® (13 x 65 mm), (2,6; 2,9; 3,4; 3,8 ml)	
[8]	*	Sarstedt S-Monovette® (13 x 75 mm), (2,7; 3; 4,3 ml)	
[8]	*	Sarstedt S-Monovette® (13 x 90 mm), (4,9; 5,6 ml)	
[8]	15120	5 ml probówka szklana (12 x 75 mm) 5 ml glass tube (12 x 75 mm)	
14815 Rmax 110 RCF 1968			
[8]	*	Sarstedt S-Monovette® (15 x 75 mm), (4; 4,3; 5,5 ml)	
[8]	*	10 ml Thermo Nalgene® Oak Ridge (16 x 81,5 mm)	
[8]	15121	10 ml probówka z dnem okrągłym i pokrywką (17 x 70 mm) 10 ml tube, round bottom, with cap (17 x 70 mm)	
12218			
RPM 3000 RCF 916 Rmax 91 \pm 90			
13219			
bez wkładki/without adapter			
[2]	15102	płytką titracyjną MTP 28,8ml (86x128x15/17,5 mm) microtiter plate MTP 28,8 ml (86 x 128 x 15/17,5 mm)	

A. Wyposażenie dodatkowe/Optional accessories**MPW M-UNIVERSAL****12300****RPM 13000 RCF 16816 Rmax 89 α 90**

bez pojemnika/without bucket

bez wkładki/without adapter

[24] 15100 37 μ l kapilarna hematokrytowa (1,4 x 75 mm)
37 μ l micro-hematocrit capillary tube (1,4 x 75 mm)**12200****RPM 4000 RCF 2164 Rmax 121 α 90**

13113 R max 121 RCF 2164 x g

bez wkładki/without adapter Rmax 121 RCF 2164

[48] * BD Vacutainer® (13 x 75 mm), (1,6-5,3 ml)

[48] * Greiner Vacuette® (13 x 75 mm), (1-4,5 ml)

[48] * Sarstedt S-Monovette® (11 x 66 mm), (1,6; 2; 2,7; 3; 3,1 ml)

[48] * Sarstedt S-Monovette® (13 x 65 mm), (2,6; 2,9; 3,4; 3,8 ml)

12200**RPM 4000 RCF 2504 Rmax 140 α 90**

13200

14013

[32] * BD Vacutainer® (13 x 100 mm), (4-7 ml)

[32] * Greiner Vacuette® (13 x 100 mm), (3,5-6 ml)

[32] * Sarstedt S-Monovette® (11 x 92 mm), (4,5; 5 ml)

[32] * BD Vacutainer® (13 x 75 mm), (1,6-5,3 ml)

[32] * Greiner Vacuette® (13 x 75 mm), (1-4,5 ml)

[32] * Sarstedt S-Monovette® (13 x 65 mm), (2,6; 2,9; 3,4; 3,8 ml)

[32] * Sarstedt S-Monovette® (13 x 75 mm), (2,7; 3; 4,3 ml)

[32] * Sarstedt S-Monovette® (13 x 90 mm), (4,9; 5,6 ml)

[32] 15054 6 ml probówka z pokrywką (11,5 x 92 mm), Sarstedt®
6 ml tube with cap (11,5 x 92 mm), Sarstedt®[32] 15119 7 ml probówka szklana (12 x 100 mm)
7 ml glass tube (12 x 100 mm)[32] 15120 5 ml probówka szklana (12 x 75 mm)
5 ml glass tube (12 x 75 mm)[32] 15419 5 ml probówka z korkiem (12 x 85 mm), Sarstedt®
5 ml tube with cap (12 x 85 mm), Sarstedt®

14016

[28] * Sarstedt S-Monovette® (15 x 75 mm), (4; 4,3; 5,5 ml)

[28] * BD Vacutainer® (16 x 100 mm), (2,5-11 ml)

[28] * Greiner Vacuette® (16 x 100 mm), (7-9 ml)

[28] * Sarstedt S-Monovette® (15 x 92 mm), (7,5; 8,2; 8,5 ml)

[28] * 10 ml Thermo Nalgene® Oak Ridge (16 x 81,5 mm)

[28] 15053 10 ml probówka z pokrywką (16 x 106 mm)
10 ml tube with cap (16 x 106 mm)[28] 15118 10 ml probówka szklana (16 x 100 mm)
10 ml glass tube (16 x 100 mm)[28] 15046 14 ml probówka z pokrywką (16,8 x 113,7 mm), Sarstedt®
14 ml tube with cap (16,8 x 113,7 mm), Sarstedt®

14020

[20] * Sarstedt S-Monovette® (15 x 75 mm), (4; 4,3; 5,5 ml)

[20] * 10 ml Thermo Nalgene® Oak Ridge (16 x 81,5 mm)

[20] * BD Vacutainer® (16 x 100 mm), (2,5-11 ml)

[20] * Greiner Vacuette® (16 x 100 mm), (7-9 ml)

[20] * Sarstedt S-Monovette® (15 x 92 mm), (7,5; 8,2; 8,5 ml)

[20] * Sarstedt S-Monovette® (16 x 92 mm), (9; 10 ml)

[20] 15053 10 ml probówka z pokrywką (16 x 106 mm)
10 ml tube with cap (16 x 106 mm)[20] 15118 10 ml probówka szklana (16 x 100 mm)
10 ml glass tube (16 x 100 mm)[20] * 13 ml probówka (\emptyset 16x100mm), Sarstedt® nr 62.515.006
13 ml tube (\emptyset 16 x 100 mm), Sarstedt® no. 62.515.006[20] 15046 14 ml probówka z pokrywką (16,8 x 113,7 mm), Sarstedt®
14 ml tube with cap (16,8 x 113,7 mm), Sarstedt®[20] 15121 10 ml probówka z dnem okrągłym i pokrywką (17 x 70 mm)
10 ml tube, round bottom, with cap (17 x 70 mm)

14021

A. Wyposażenie dodatkowe/Optional accessories
MPW M-UNIVERSAL

[40]	*	2-1,5 ml probówka (10,8x41,8 mm), Eppendorf®; [15011], 2 ml (10,8x41,8 mm); [15128], 1,5ml (10,8x40,5 mm) 2-1,5 ml tube (10,8x41,8 mm), Eppendorf®; [15011], 2 ml (10,8x41,8 mm); [15128], 1,5ml (10,8x40,5 mm)
[40]	*	2 ml probówki z filtrem - spin columns (10,8 x 46 mm) 2 ml spin columns (with filter) (10,8 x 46 mm); [15011], 2 ml (10,8x41,8 mm); [15128], 1,5ml (10,8x40,5 mm)
		14023
[4]	*	28 ml Thermo Nalgene® Oak Ridge (25,4 x 101,8 mm)
[4]	15056	30 ml Thermo Nalgene® Oak Ridge (25,5 x 94,3 mm) 30 ml Thermo Nalgene® Oak Ridge (25,5 x 94,3 mm)
[4]	15055	30 ml probówka z pokrywką (25,4 x 103,2 mm) 30 ml tube with cap (25,4 x 103,2 mm)
[4]	15222	30 ml probówka z pokrywką (25 x 94mm), Sterilin® 30 ml tube with cap (25 x 94 mm), Sterilin®
[4]	15223	30 ml probówka z pokrywką (25 x 94 mm), Sterilin® 30 ml tube with cap (25 x 94 mm), Sterilin®
[4]	15117	25 ml probówka szklana (25 x 100 mm) 25 ml glass tube (25 x 100 mm)
[4]	15424	30 ml probówka z pokrywką (25,5 x 94 mm), Nalgene® 30 ml tube with cap (25,5 x 94 mm), Nalgene®
		14026
[4]	*	50 ml probówka z dnem stożkowym z rantem (30 x 115 mm), Greiner® 50 ml tube, conical bottom, skirted (30 x 115 mm), Greiner®
		14026+14188
[4]	15051	50 ml Thermo Nalgene® Oak Ridge (28,8 x 106,7 mm) 50 ml Thermo Nalgene® Oak Ridge (28,8 x 106,7 mm)
[4]	*	50 ml probówka z dnem stożkowym z zakrętką (30 x 117 mm), Falcon®; [15052] 50ml (30 x 117mm) 50 ml tube, conical bottom, with cap (30 x 117 mm), Falcon®; [15052] 50ml Sarstedt® (30 x 117 mm)
[4]	*	50 ml probówka z dnem stożkowym bez rantu (30 x 115 mm), Greiner® 50 ml tube, conical bottom, without skirt (30 x 115 mm), Greiner®
[4]	*	50 ml probówka Advanced Oak Ridge (29x102 mm), Herolab® nr 25 32 11 50 ml tube, Advanced Oak Ridge (29 x 102 mm), Herolab® no. 25 32 11
		14028
[4]	15116	50 ml probówka szklana (35 x 100 mm) 50 ml glass tube (35 x 100 mm)
		14029
[48]	*	Sarstedt S-Monovette® (11 x 92 mm), (4,5; 5 ml)
[48]	*	Sarstedt S-Monovette® (11 x 66 mm), (1,6; 2; 2,7; 3; 3,1 ml)
[48]	15054	6 ml probówka z pokrywką (11,5 x 92 mm), Sarstedt® 6 ml tube with cap (11,5 x 92 mm), Sarstedt®
[48]	15119	7 ml probówka szklana (12 x 100 mm) 7 ml glass tube (12 x 100 mm)
[48]	15120	5 ml probówka szklana (12 x 75 mm) 5 ml glass tube (12 x 75 mm)
[48]	15419	5 ml probówka z korkiem (12 x 85 mm), Sarstedt® 5 ml tube with cap (12 x 85 mm), Sarstedt®
		14100+14196
[4]	15040	100 ml probówka z pokrywką (45,2 x 103,7 mm) 100 ml tube with cap (45,2 x 103,7 mm)
		14100+14188
[4]	15115	100 ml probówka szklana (44 x 100 mm) 100 ml glass tube (44 x 100 mm)
		14027
[4]	*	15 ml probówka z dnem stożkowym z zakrętką (17 x 120 mm), Falcon®; [15050], 15ml (17 x 120 mm) 15 ml tube, conical bottom, with cap (17 x 120 mm), Falcon®; [15050] 15ml Sarstedt®(17 x 120 mm)
		13201+17202
		14013
[32]	*	BD Vacutainer® (13 x 100 mm), (4-7 ml)
[32]	*	Greiner Vacuette® (13 x 100 mm), (3,5-6 ml)
[32]	*	Sarstedt S-Monovette® (11 x 92 mm), (4,5; 5 ml)
[32]	*	BD Vacutainer® (13 x 75 mm), (1,6-5,3 ml)
[32]	*	Greiner Vacuette® (13 x 75 mm), (1-4,5 ml)
[32]	*	Sarstedt S-Monovette® (13 x 65 mm), (2,6; 2,9; 3,4; 3,8 ml)
[32]	*	Sarstedt S-Monovette® (13 x 75 mm), (2,7; 3; 4,3 ml)
[32]	*	Sarstedt S-Monovette® (13 x 90 mm), (4,9; 5,6 ml)
[32]	15054	6 ml probówka z pokrywką (11,5 x 92 mm), Sarstedt® 6 ml tube with cap (11,5 x 92 mm), Sarstedt®
[32]	15119	7 ml probówka szklana (12 x 100 mm) 7 ml glass tube (12 x 100 mm)
[32]	15120	5 ml probówka szklana (12 x 75 mm) 5 ml glass tube (12 x 75 mm)

A. Wyposażenie dodatkowe/Optional accessories**MPW M-UNIVERSAL**

[32]	15419	5 ml probówka z korkiem (12 x 85 mm), Sarstedt® 5 ml tube with cap (12 x 85 mm), Sarstedt®
14016		
[28]	*	Sarstedt S-Monovette® (15 x 75 mm), (4; 4,3; 5,5 ml)
[28]	*	BD Vacutainer® (16 x 100 mm), (2,5-11 ml)
[28]	*	Greiner Vacuette® (16 x 100 mm), (7-9 ml)
[28]	*	10 ml Thermo Nalgene® Oak Ridge (16 x 81,5 mm)
[28]	15053	10 ml probówka z pokrywką (16 x 106 mm) 10 ml tube with cap (16 x 106 mm)
[28]	15118	10 ml probówka szklana (16 x 100 mm) 10 ml glass tube (16 x 100 mm)
[28]	15046	14 ml probówka z pokrywką (16,8 x 113,7 mm), Sarstedt® 14 ml tube with cap (16,8 x 113,7 mm), Sarstedt®
14020		
[20]	*	Sarstedt S-Monovette® (15 x 75 mm), (4; 4,3; 5,5 ml)
[20]	*	10 ml Thermo Nalgene® Oak Ridge (16 x 81,5 mm)
[20]	*	BD Vacutainer® (16 x 100 mm), (2,5-11 ml)
[20]	*	Greiner Vacuette® (16 x 100 mm), (7-9 ml)
[20]	15053	10 ml probówka z pokrywką (16 x 106 mm) 10 ml tube with cap (16 x 106 mm)
[20]	15118	10 ml probówka szklana (16 x 100 mm) 10 ml glass tube (16 x 100 mm)
[20]	*	13 ml probówka (ø16x100mm), Sarstedt® nr 62.515.006 13 ml tube (ø16 x 100 mm), Sarstedt® no. 62.515.006
[20]	15046	14 ml probówka z pokrywką (16,8 x 113,7 mm), Sarstedt® 14 ml tube with cap (16,8 x 113,7 mm), Sarstedt®
[20]	15121	10 ml probówka z dnem okrągłym i pokrywką (17 x 70 mm) 10 ml tube, round bottom, with cap (17 x 70 mm)
14021		
[40]	*	2-1,5 ml probówka (10,8x41,8 mm), Eppendorf®; [15011], 2 ml (10,8x41,8 mm); [15128], 1,5ml (10,8x40,5 mm) 2-1,5 ml tube (10,8x41,8 mm), Eppendorf®; [15011], 2 ml (10,8x41,8 mm); [15128], 1,5ml (10,8x40,5 mm)
[40]	*	2 ml probówki z filtrem - spin columns (10,8 x 46 mm) 2 ml spin columns (with filter) (10,8 x 46 mm); [15011], 2 ml (10,8x41,8 mm); [15128], 1,5ml (10,8x40,5 mm)
14023		
[4]	*	28 ml Thermo Nalgene® Oak Ridge (25,4 x 101,8 mm)
[4]	15056	30 ml Thermo Nalgene® Oak Ridge (25,5 x 94,3 mm) 30 ml Thermo Nalgene® Oak Ridge (25,5 x 94,3 mm)
[4]	15055	30 ml probówka z pokrywką (25,4 x 103,2 mm) 30 ml tube with cap (25,4 x 103,2 mm)
[4]	15222	30 ml probówka z pokrywką (25 x 94mm), Sterilin® 30 ml tube with cap (25 x 94 mm), Sterilin®
[4]	15223	30 ml probówka z pokrywką (25 x 94 mm), Sterilin® 30 ml tube with cap (25 x 94 mm), Sterilin®
[4]	15117	25 ml probówka szklana (25 x 100 mm) 25 ml glass tube (25 x 100 mm)
[4]	15424	30 ml probówka z pokrywką (25,5 x 94 mm), Nalgene® 30 ml tube with cap (25,5 x 94 mm), Nalgene®
14026+14188		
[4]	15051	50 ml Thermo Nalgene® Oak Ridge (28,8 x 106,7 mm) 50 ml Thermo Nalgene® Oak Ridge (28,8 x 106,7 mm)
14028		
[4]	15116	50 ml probówka szklana (35 x 100 mm) 50 ml glass tube (35 x 100 mm)
14029		
[48]	*	Sarstedt S-Monovette® (11 x 66 mm), (1,6; 2; 2,7; 3; 3,1 ml)
[48]	15054	6 ml probówka z pokrywką (11,5 x 92 mm), Sarstedt® 6 ml tube with cap (11,5 x 92 mm), Sarstedt®
[48]	15119	7 ml probówka szklana (12 x 100 mm) 7 ml glass tube (12 x 100 mm)
[48]	15120	5 ml probówka szklana (12 x 75 mm) 5 ml glass tube (12 x 75 mm)
[48]	15419	5 ml probówka z korkiem (12 x 85 mm), Sarstedt® 5 ml tube with cap (12 x 85 mm), Sarstedt®
14100+14196		
[4]	15040	100 ml probówka z pokrywką (45,2 x 103,7 mm) 100 ml tube with cap (45,2 x 103,7 mm)
14100+14188		
[4]	15115	100 ml probówka szklana (44 x 100 mm) 100 ml glass tube (44 x 100 mm)
13201+17203		

A. Wyposażenie dodatkowe/Optional accessories	
MPW M-UNIVERSAL	
14021	
[40]	* 2-1,5 ml probówka (10,8x41,8 mm), Eppendorf®; [15011], 2 ml (10,8x41,8 mm); [15128], 1,5ml (10,8x40,5 mm) 2-1,5 ml tube (10,8x41,8 mm), Eppendorf®; [15011], 2 ml (10,8x41,8 mm); [15128], 1,5ml (10,8x40,5 mm)
[40]	* 2 ml probówki z filtrem - spin columns (10,8 x 46 mm) 2 ml spin columns (with filter) (10,8 x 46 mm); [15011], 2 ml (10,8x41,8 mm); [15128], 1,5ml (10,8x40,5 mm)
14026	
[4]	* 50 ml probówka z dnem stożkowym z rantem (30 x 115 mm), Greiner® 50 ml tube, conical bottom, skirted (30 x 115 mm), Greiner®
14026+14188	
[4]	15051 50 ml Thermo Nalgene® Oak Ridge (28,8 x 106,7 mm) 50 ml Thermo Nalgene® Oak Ridge (28,8 x 106,7 mm)
[4]	* 50 ml probówka z dnem stożkowym z zakrętką (30 x 117 mm), Falcon®; [15052] 50ml (30 x 117mm) 50 ml tube, conical bottom, with cap (30 x 117 mm), Falcon®; [15052] 50ml Sarstedt® (30 x 117 mm)
[4]	* 50 ml probówka z dnem stożkowym bez rantu (30 x 115 mm), Greiner® 50 ml tube, conical bottom, without skirt (30 x 115 mm), Greiner®
[4]	* 50 ml probówka Advanced Oak Ridge (29x102 mm), Herolab® nr 25 32 11 50 ml tube, Advanced Oak Ridge (29 x 102 mm), Herolab® no. 25 32 11
14028	
[4]	15116 50 ml probówka szklana (35 x 100 mm) 50 ml glass tube (35 x 100 mm)
14100+14196	
[4]	15040 100 ml probówka z pokrywką (45,2 x 103,7 mm) 100 ml tube with cap (45,2 x 103,7 mm)
14100+14188	
[4]	15115 100 ml probówka szklana (44 x 100 mm) 100 ml glass tube (44 x 100 mm)
14027	
[4]	* 15 ml probówka z dnem stożkowym z zakrętką (17 x 120 mm), Falcon®; [15050], 15ml (17 x 120 mm) 15 ml tube, conical bottom, with cap (17 x 120 mm), Falcon®; [15050] 15ml Sarstedt®(17 x 120 mm)
12200	
RPM 4000 RCF 2469 Rmax 138 \pm 90	
13215 R max 138 RCF 2469 x g	
bez wkładki/without adapter Rmax 138 RCF 2469	
[8]	* BD Vacutainer® (16 x 100 mm), (2,5-11 ml)
[8]	* Greiner Vacuette® (16 x 100 mm), (7-9 ml)
[8]	* Sarstedt S-Monovette® (15 x 92 mm), (7,5; 8,2; 8,5 ml)
[8]	* Sarstedt S-Monovette® (16 x 92 mm), (9; 10 ml)
[8]	15046 14 ml probówka z pokrywką (16,8 x 113,7 mm), Sarstedt® 14 ml tube with cap (16,8 x 113,7 mm), Sarstedt®
[8]	15048 15 ml Thermo Nalgene® (16 x 113 mm) 15 ml Thermo Nalgene® (16 x 113 mm)
[8]	15053 10 ml probówka z pokrywką (16 x 106 mm) 10 ml tube with cap (16 x 106 mm)
[8]	15118 10 ml probówka szklana (16 x 100 mm) 10 ml glass tube (16 x 100 mm)
[8]	* 15 ml probówka z dnem stożkowym z zakrętką (17 x 120 mm), Falcon®; [15050], 15ml (17 x 120 mm) 15 ml tube, conical bottom, with cap (17 x 120 mm), Falcon®; [15050] 15ml Sarstedt®(17 x 120 mm)
14082 Rmax 138 RCF 2469	
[8]	* BD Vacutainer® (13 x 100 mm), (4-7 ml)
[8]	* Greiner Vacuette® (13 x 100 mm), (3,5-6 ml)
[8]	* Sarstedt S-Monovette® (11 x 92 mm), (4,5; 5 ml)
[8]	15054 6 ml probówka z pokrywką (11,5 x 92 mm), Sarstedt® 6 ml tube with cap (11,5 x 92 mm), Sarstedt®
[8]	15119 7 ml probówka szklana (12 x 100 mm) 7 ml glass tube (12 x 100 mm)
11501	
RPM 4500 RCF 2966 Rmax 131 \pm 30	
13080 R max 131 RCF 2966 x g	
14082 Rmax 131 RCF 2966	
[30]	* BD Vacutainer® (13 x 100 mm), (4-7 ml)
[30]	* Greiner Vacuette® (13 x 100 mm), (3,5-6 ml)
[30]	* Sarstedt S-Monovette® (11 x 92 mm), (4,5; 5 ml)
[30]	15054 6 ml probówka z pokrywką (11,5 x 92 mm), Sarstedt® 6 ml tube with cap (11,5 x 92 mm), Sarstedt®
[30]	15119 7 ml probówka szklana (12 x 100 mm) 7 ml glass tube (12 x 100 mm)
bez wkładki/without adapter Rmax 131 RCF 2966	

* probówka niedostępna w ofercie MPW lub dostępny odpowiednik (np:[15050]), patrz kolumna z prawej
tube is not offered by MPW or equivalent is available (e.g. [15050]), see column on the right

A. Wyposażenie dodatkowe/Optional accessories**MPW M-UNIVERSAL**

[30]	*	BD Vacutainer® (16 x 100 mm), (2,5-11 ml)
[30]	*	Greiner Vacuette® (16 x 100 mm), (7-9 ml)
[30]	*	Sarstedt S-Monovette® (15 x 92 mm), (7,5; 8,2; 8,5 ml)
[30]	*	Sarstedt S-Monovette® (16 x 92 mm), (9; 10 ml)
[30]	15046	14 ml probówka z pokrywką (16,8 x 113,7 mm), Sarstedt® 14 ml tube with cap (16,8 x 113,7 mm), Sarstedt®
[30]	15048	15 ml Thermo Nalgene® (16 x 113 mm) 15 ml Thermo Nalgene® (16 x 113 mm)
[30]	15053	10 ml probówka z pokrywką (16 x 106 mm) 10 ml tube with cap (16 x 106 mm)
[30]	15118	10 ml probówka szklana (16 x 100 mm) 10 ml glass tube (16 x 100 mm)
[30]	*	15 ml probówka z dnem stożkowym z zakrętką (17 x 120 mm), Falcon®; [15050], 15ml (17 x 120 mm) 15 ml tube, conical bottom, with cap (17 x 120 mm), Falcon®; [15050] 15ml Sarstedt®(17 x 120 mm)

11743**RPM 5500 RCF 3889 Rmax 115 ϕ 30**

13329

bez wkładki/without adapter

[12]	15055	30 ml probówka z pokrywką (25,4 x 103,2 mm) 30 ml tube with cap (25,4 x 103,2 mm)
[12]	15424	30 ml probówka z pokrywką (25,5 x 94 mm), Nalgene® 30 ml tube with cap (25,5 x 94 mm), Nalgene®
[12]	15222	30 ml probówka z pokrywką (25 x 94mm), Sterilin® 30 ml tube with cap (25 x 94 mm), Sterilin®
[12]	15223	30 ml probówka z pokrywką (25 x 94 mm), Sterilin® 30 ml tube with cap (25 x 94 mm), Sterilin®
14256		
[12]	15046	14 ml probówka z pokrywką (16,8 x 113,7 mm), Sarstedt® 14 ml tube with cap (16,8 x 113,7 mm), Sarstedt®
[12]	15048	15 ml Thermo Nalgene® (16 x 113 mm) 15 ml Thermo Nalgene® (16 x 113 mm)
[12]	15053	10 ml probówka z pokrywką (16 x 106 mm) 10 ml tube with cap (16 x 106 mm)
[12]	15118	10 ml probówka szklana (16 x 100 mm) 10 ml glass tube (16 x 100 mm)
14255		
[12]	*	Sarstedt S-Monovette® (11 x 92 mm), (4,5; 5 ml)
[12]	15119	7 ml probówka szklana (12 x 100 mm) 7 ml glass tube (12 x 100 mm)

Suma końcowa

A. Wyposażenie dodatkowe/Optional accessories**MPW M-DIAGNOSTIC****WIRNIK / ROTOR**PARAMETRY WIRNIKA / ROTOR PARAMETERS (RCF [x g], Rmax [mm], α [°])

POJEMNIK/BUCKET

WKŁADKA / ADAPTER

[liczba probówek na wirnik/tubes per rotor] PROBÓWKA / TUBE

11501**RPM 4500 RCF 2717 Rmax 120 α 30**

13080

14082+14815 Rmax 120 RCF 2717

[30] * BD Vacutainer® (13 x 75 mm), (1,6-5,3 ml)

[30] * Greiner Vacuette® (13 x 75 mm), (1-4,5 ml)

[30] * Sarstedt S-Monovette® (11 x 66 mm), (1,6; 2; 2,7; 3; 3,1 ml)

[30] * Sarstedt S-Monovette® (13 x 65 mm), (2,6; 2,9; 3,4; 3,8 ml)

[30] * Sarstedt S-Monovette® (13 x 75 mm), (2,7; 3; 4,3 ml)

[30] 15120 5 ml probówka szklana (12 x 75 mm)

5 ml glass tube (12 x 75 mm)

14815 Rmax 120 RCF 2717

[30] * Sarstedt S-Monovette® (15 x 75 mm), (4; 4,3; 5,5 ml)

[30] * 10 ml Thermo Nalgene® Oak Ridge (16 x 81,5 mm)

[30] 15121 10 ml probówka z dnem okrągłym i pokrywką (17 x 70 mm)

10 ml tube, round bottom, with cap (17 x 70 mm)

11720**RPM 5000 RCF 3634 Rmax 130 α 45**

13721

bez wkładki/without adapter

[4] * Orthokine®vet 60ml

11740**RPM 5500 RCF 4058 Rmax 120 α 30**

13080

14082

[12] * BD Vacutainer® (13 x 100 mm), (4-7 ml)

[12] * Greiner Vacuette® (13 x 100 mm), (3,5-6 ml)

[12] * Sarstedt S-Monovette® (11 x 92 mm), (4,5; 5 ml)

[12] 15054 6 ml probówka z pokrywką (11,5 x 92 mm), Sarstedt®

6 ml tube with cap (11,5 x 92 mm), Sarstedt®

[12] 15119 7 ml probówka szklana (12 x 100 mm)

7 ml glass tube (12 x 100 mm)

bez wkładki/without adapter

[12] * BD Vacutainer® (16 x 100 mm), (2,5-11 ml)

[12] * Greiner Vacuette® (16 x 100 mm), (7-9 ml)

[12] * Sarstedt S-Monovette® (15 x 92 mm), (7,5; 8,2; 8,5 ml)

[12] * Sarstedt S-Monovette® (16 x 92 mm), (9; 10 ml)

[12] 15046 14 ml probówka z pokrywką (16,8 x 113,7 mm), Sarstedt®

14 ml tube with cap (16,8 x 113,7 mm), Sarstedt®

[12] 15048 15 ml Thermo Nalgene® (16 x 113 mm)

15 ml Thermo Nalgene® (16 x 113 mm)

[12] 15053 10 ml probówka z pokrywką (16 x 106 mm)

10 ml tube with cap (16 x 106 mm)

[12] 15118 10 ml probówka szklana (16 x 100 mm)

10 ml glass tube (16 x 100 mm)

[12] * 15 ml probówka z dnem stożkowym z zakrętką (17 x 120 mm), Falcon®; [15050], 15ml (17 x 120 mm)

15 ml tube, conical bottom, with cap (17 x 120 mm), Falcon®; [15050] 15ml Sarstedt®(17 x 120 mm)

11740**RPM 5500 RCF 3416 Rmax 101 α 30**

13080

A. Wyposażenie dodatkowe/Optional accessories	
MPW M-DIAGNOSTIC	
14082+14815	
[12]	15120 5 ml probówka szklana (12 x 75 mm) 5 ml glass tube (12 x 75 mm)
14082+14815 Rmax 101 RCF 3416	
[12]	* BD Vacutainer® (13 x 75 mm), (1,6-5,3 ml)
[12]	* Greiner Vacuette® (13 x 75 mm), (1-4,5 ml)
[12]	* Sarstedt S-Monovette® (11 x 66 mm), (1,6; 2; 2,7; 3; 3,1 ml)
[12]	* Sarstedt S-Monovette® (13 x 65 mm), (2,6; 2,9; 3,4; 3,8 ml)
[12]	* Sarstedt S-Monovette® (13 x 75 mm), (2,7; 3; 4,3 ml)
14815 Rmax 101 RCF 3416	
[12]	* Sarstedt S-Monovette® (15 x 75 mm), (4; 4,3; 5,5 ml)
[12]	* 10 ml Thermo Nalgene® Oak Ridge (16 x 81,5 mm)
[12]	15121 10 ml probówka z dnem okrągłym i pokrywką (17 x 70 mm) 10 ml tube, round bottom, with cap (17 x 70 mm)
11741	
RPM 6000 RCF 4226 Rmax 105 ± 30	
13080	
14082	
[8]	* BD Vacutainer® (13 x 100 mm), (4-7 ml)
[8]	* Greiner Vacuette® (13 x 100 mm), (3,5-6 ml)
[8]	* Sarstedt S-Monovette® (11 x 92 mm), (4,5; 5 ml)
[8]	15054 6 ml probówka z pokrywką (11,5 x 92 mm), Sarstedt® 6 ml tube with cap (11,5 x 92 mm), Sarstedt®
[8]	15119 7 ml probówka szklana (12 x 100 mm) 7 ml glass tube (12 x 100 mm)
bez wkładki/without adapter	
[8]	* BD Vacutainer® (16 x 100 mm), (2,5-11 ml)
[8]	* Greiner Vacuette® (16 x 100 mm), (7-9 ml)
[8]	* Sarstedt S-Monovette® (15 x 92 mm), (7,5; 8,2; 8,5 ml)
[8]	* Sarstedt S-Monovette® (16 x 92 mm), (9; 10 ml)
[8]	15046 14 ml probówka z pokrywką (16,8 x 113,7 mm), Sarstedt® 14 ml tube with cap (16,8 x 113,7 mm), Sarstedt®
[8]	15048 15 ml Thermo Nalgene® (16 x 113 mm) 15 ml Thermo Nalgene® (16 x 113 mm)
[8]	15053 10 ml probówka z pokrywką (16 x 106 mm) 10 ml tube with cap (16 x 106 mm)
[8]	15118 10 ml probówka szklana (16 x 100 mm) 10 ml glass tube (16 x 100 mm)
[8]	* 15 ml probówka z dnem stożkowym z zakrętką (17 x 120 mm), Falcon®; [15050], 15ml (17 x 120 mm) 15 ml tube, conical bottom, with cap (17 x 120 mm), Falcon®; [15050] 15ml Sarstedt®(17 x 120 mm)
11741	
RPM 6000 RCF 3502 Rmax 87 ± 30	
13080	
14082+14815	
[8]	15120 5 ml probówka szklana (12 x 75 mm) 5 ml glass tube (12 x 75 mm)
14082+14815 Rmax 87 RCF 3502	
[8]	* BD Vacutainer® (13 x 75 mm), (1,6-5,3 ml)
[8]	* Greiner Vacuette® (13 x 75 mm), (1-4,5 ml)
[8]	* Sarstedt S-Monovette® (11 x 66 mm), (1,6; 2; 2,7; 3; 3,1 ml)
[8]	* Sarstedt S-Monovette® (13 x 65 mm), (2,6; 2,9; 3,4; 3,8 ml)
[8]	* Sarstedt S-Monovette® (13 x 75 mm), (2,7; 3; 4,3 ml)
14815 Rmax 87 RCF 3502	
[8]	* Sarstedt S-Monovette® (15 x 75 mm), (4; 4,3; 5,5 ml)
[8]	* 10 ml Thermo Nalgene® Oak Ridge (16 x 81,5 mm)
[8]	15121 10 ml probówka z dnem okrągłym i pokrywką (17 x 70 mm) 10 ml tube, round bottom, with cap (17 x 70 mm)
11744	
RPM 4500 RCF 2830 Rmax 125 ± 30	
13276	
bez wkładki/without adapter	
[10]	15051 50 ml Thermo Nalgene® Oak Ridge (28,8 x 106,7 mm) 50 ml Thermo Nalgene® Oak Ridge (28,8 x 106,7 mm)

A. Wyposażenie dodatkowe/Optional accessories**MPW M-DIAGNOSTIC**

[10]	*	50 ml probówka z dnem stożkowym z zakrętką (30 x 117 mm), Falcon®; [15052] 50ml (30 x 117mm) 50 ml tube, conical bottom, with cap (30 x 117 mm), Falcon®; [15052] 50ml Sarstedt® (30 x 117 mm)
[10]	*	50 ml probówka z dnem stożkowym bez rantu (30 x 115 mm), Greiner® 50 ml tube, conical bottom, without skirt (30 x 115 mm), Greiner®
[10]	*	50 ml probówka Advanced Oak Ridge (29x102 mm), Herolab® nr 25 32 11 50 ml tube, Advanced Oak Ridge (29 x 102 mm), Herolab® no. 25 32 11
14035		
[10]	15046	14 ml probówka z pokrywką (16,8 x 113,7 mm), Sarstedt® 14 ml tube with cap (16,8 x 113,7 mm), Sarstedt®
[10]	15048	15 ml Thermo Nalgene® (16 x 113 mm) 15 ml Thermo Nalgene® (16 x 113 mm)
[10]	15053	10 ml probówka z pokrywką (16 x 106 mm) 10 ml tube with cap (16 x 106 mm)
[10]	15118	10 ml probówka szklana (16 x 100 mm) 10 ml glass tube (16 x 100 mm)
14036		
[10]	*	BD Vacutainer® (13 x 100 mm), (4-7 ml)
[10]	*	Greiner Vacuette® (13 x 100 mm), (3,5-6 ml)
[10]	15054	6 ml probówka z pokrywką (11,5 x 92 mm), Sarstedt® 6 ml tube with cap (11,5 x 92 mm), Sarstedt®
[10]	15119	7 ml probówka szklana (12 x 100 mm) 7 ml glass tube (12 x 100 mm)
14043		
[10]	*	Greiner Vacuette® (13 x 75 mm), (1-4,5 ml)
[10]	*	Sarstedt S-Monovette® (13 x 75 mm), (2,7; 3; 4,3 ml)
[10]	*	Sarstedt S-Monovette® (13 x 90 mm), (4,9; 5,6 ml)
[10]	15120	5 ml probówka szklana (12 x 75 mm) 5 ml glass tube (12 x 75 mm)
[10]	15419	5 ml probówka z korkiem (12 x 85 mm), Sarstedt® 5 ml tube with cap (12 x 85 mm), Sarstedt®
14071		
[10]	*	28 ml Thermo Nalgene® Oak Ridge (25,4 x 101,8 mm)
[10]	15055	30 ml probówka z pokrywką (25,4 x 103,2 mm) 30 ml tube with cap (25,4 x 103,2 mm)
[10]	15056	30 ml Thermo Nalgene® Oak Ridge (25,5 x 94,3 mm) 30 ml Thermo Nalgene® Oak Ridge (25,5 x 94,3 mm)
[10]	15424	30 ml probówka z pokrywką (25,5 x 94 mm), Nalgene® 30 ml tube with cap (25,5 x 94 mm), Nalgene®
14073		
[10]	*	Greiner Vacuette® (16 x 100 mm), (7-9 ml)
[10]	*	Sarstedt S-Monovette® (15 x 92 mm), (7,5; 8,2; 8,5 ml)
[10]	*	BD Vacutainer® (16 x 100 mm), (2,5-11 ml)
[10]	*	Sarstedt S-Monovette® (16 x 92 mm), (9; 10 ml)
[10]	15046	14 ml probówka z pokrywką (16,8 x 113,7 mm), Sarstedt® 14 ml tube with cap (16,8 x 113,7 mm), Sarstedt®
[10]	15048	15 ml Thermo Nalgene® (16 x 113 mm) 15 ml Thermo Nalgene® (16 x 113 mm)
[10]	15053	10 ml probówka z pokrywką (16 x 106 mm) 10 ml tube with cap (16 x 106 mm)
[10]	15118	10 ml probówka szklana (16 x 100 mm) 10 ml glass tube (16 x 100 mm)
14089		
[10]	*	15 ml probówka z dnem stożkowym z zakrętką (17 x 120 mm), Falcon®; [15050], 15ml (17 x 120 mm) 15 ml tube, conical bottom, with cap (17 x 120 mm), Falcon®; [15050] 15ml Sarstedt®(17 x 120 mm)
14248		
[10]	15055	30 ml probówka z pokrywką (25,4 x 103,2 mm) 30 ml tube with cap (25,4 x 103,2 mm)
14089+14868		
[10]	*	5 ml probówka z korkiem wciskany (17 x 54,2 mm), Eppendorf® 5 ml tube with snap cap (17 x 54,2 mm), Eppendorf®
[10]	*	5 ml probówka z korkiem zakręcany (17 x 66 mm), Eppendorf® 5 ml tube with screw cap (17 x 66 mm), Eppendorf®

11745**RPM 5000 RCF 3354 Rmax 120 \pm 30**

13080

14082

[24]	*	BD Vacutainer® (13 x 100 mm), (4-7 ml)
[24]	*	Greiner Vacuette® (13 x 100 mm), (3,5-6 ml)
[24]	*	Sarstedt S-Monovette® (11 x 92 mm), (4,5; 5 ml)

* probówka niedostępna w ofercie MPW lub dostępny odpowiednik (np:[15050]), patrz kolumna z prawej
tube is not offered by MPW or equivalent is available (e.g. [15050]), see column on the right

A. Wyposażenie dodatkowe/Optional accessories**MPW M-DIAGNOSTIC**

[24]	15054	6 ml probówka z pokrywką (11,5 x 92 mm), Sarstedt® 6 ml tube with cap (11,5 x 92 mm), Sarstedt®
[24]	15119	7 ml probówka szklana (12 x 100 mm) 7 ml glass tube (12 x 100 mm)
bez wkładki/without adapter		
[24]	*	BD Vacutainer® (16 x 100 mm), (2,5-11 ml)
[24]	*	Greiner Vacuette® (16 x 100 mm), (7-9 ml)
[24]	*	Sarstedt S-Monovette® (15 x 92 mm), (7,5; 8,2; 8,5 ml)
[24]	*	Sarstedt S-Monovette® (16 x 92 mm), (9; 10 ml)
[24]	15046	14 ml probówka z pokrywką (16,8 x 113,7 mm), Sarstedt® 14 ml tube with cap (16,8 x 113,7 mm), Sarstedt®
[24]	15048	15 ml Thermo Nalgene® (16 x 113 mm) 15 ml Thermo Nalgene® (16 x 113 mm)
[24]	15053	10 ml probówka z pokrywką (16 x 106 mm) 10 ml tube with cap (16 x 106 mm)
[24]	15118	10 ml probówka szklana (16 x 100 mm) 10 ml glass tube (16 x 100 mm)
[24]	*	15 ml probówka z dnem stożkowym z zakrętką (17 x 120 mm), Falcon®; [15050], 15ml (17 x 120 mm) 15 ml tube, conical bottom, with cap (17 x 120 mm), Falcon®; [15050] 15ml Sarstedt®(17 x 120 mm)

11745**RPM 5000 RCF 2935 Rmax 105 α 30**

13080

14082+14815 Rmax 105 RCF 2935

[24]	*	BD Vacutainer® (13 x 75 mm), (1,6-5,3 ml)
[24]	*	Greiner Vacuette® (13 x 75 mm), (1-4,5 ml)
[24]	*	Sarstedt S-Monovette® (11 x 66 mm), (1,6; 2; 2,7; 3; 3,1 ml)
[24]	*	Sarstedt S-Monovette® (13 x 65 mm), (2,6; 2,9; 3,4; 3,8 ml)
[24]	*	Sarstedt S-Monovette® (13 x 75 mm), (2,7; 3; 4,3 ml)
[24]	15120	5 ml probówka szklana (12 x 75 mm) 5 ml glass tube (12 x 75 mm)

14815 Rmax 105 RCF 2935

[24]	*	Sarstedt S-Monovette® (15 x 75 mm), (4; 4,3; 5,5 ml)
[24]	*	10 ml Thermo Nalgene® Oak Ridge (16 x 81,5 mm)
[24]	15121	10 ml probówka z dnem okrągłym i pokrywką (17 x 70 mm) 10 ml tube, round bottom, with cap (17 x 70 mm)

11746**RPM 6000 RCF 4427 Rmax 110 α 30**

13276

bez wkładki/without adapter

[6]	*	50 ml probówka z dnem stożkowym z zakrętką (30 x 117 mm), Falcon®; [15052] 50ml (30 x 117mm) 50 ml tube, conical bottom, with cap (30 x 117 mm), Falcon®; [15052] 50ml Sarstedt® (30 x 117 mm)
[6]	*	50 ml probówka z dnem stożkowym bez rantu (30 x 115 mm), Greiner® 50 ml tube, conical bottom, without skirt (30 x 115 mm), Greiner®
[6]	15051	50 ml Thermo Nalgene® Oak Ridge (28,8 x 106,7 mm) 50 ml Thermo Nalgene® Oak Ridge (28,8 x 106,7 mm)
[6]	*	50 ml probówka Advanced Oak Ridge (29x102 mm), Herolab® nr 25 32 11 50 ml tube, Advanced Oak Ridge (29 x 102 mm), Herolab® no. 25 32 11

14035

[6]	15046	14 ml probówka z pokrywką (16,8 x 113,7 mm), Sarstedt® 14 ml tube with cap (16,8 x 113,7 mm), Sarstedt®
[6]	15048	15 ml Thermo Nalgene® (16 x 113 mm) 15 ml Thermo Nalgene® (16 x 113 mm)
[6]	15053	10 ml probówka z pokrywką (16 x 106 mm) 10 ml tube with cap (16 x 106 mm)
[6]	15118	10 ml probówka szklana (16 x 100 mm) 10 ml glass tube (16 x 100 mm)

14036

[6]	*	BD Vacutainer® (13 x 100 mm), (4-7 ml)
[6]	*	Greiner Vacuette® (13 x 100 mm), (3,5-6 ml)
[6]	15054	6 ml probówka z pokrywką (11,5 x 92 mm), Sarstedt® 6 ml tube with cap (11,5 x 92 mm), Sarstedt®
[6]	15119	7 ml probówka szklana (12 x 100 mm) 7 ml glass tube (12 x 100 mm)

14043

[6]	*	Greiner Vacuette® (13 x 75 mm), (1-4,5 ml)
[6]	*	Sarstedt S-Monovette® (13 x 75 mm), (2,7; 3; 4,3 ml)
[6]	*	Sarstedt S-Monovette® (13 x 90 mm), (4,9; 5,6 ml)

* probówka niedostępna w ofercie MPW lub dostępny odpowiednik (np:[15050]), patrz kolumna z prawej
tube is not offered by MPW or equivalent is available (e.g. [15050]), see column on the right

A. Wyposażenie dodatkowe/Optional accessories	
MPW M-DIAGNOSTIC	
[6]	15120 5 ml probówka szklana (12 x 75 mm) 5 ml glass tube (12 x 75 mm)
[6]	15419 5 ml probówka z korkiem (12 x 85 mm), Sarstedt® 5 ml tube with cap (12 x 85 mm), Sarstedt®
14071	
[6]	* 28 ml Thermo Nalgene® Oak Ridge (25,4 x 101,8 mm)
[6]	15055 30 ml probówka z pokrywką (25,4 x 103,2 mm) 30 ml tube with cap (25,4 x 103,2 mm)
[6]	15056 30 ml Thermo Nalgene® Oak Ridge (25,5 x 94,3 mm) 30 ml Thermo Nalgene® Oak Ridge (25,5 x 94,3 mm)
[6]	15424 30 ml probówka z pokrywką (25,5 x 94 mm), Nalgene® 30 ml tube with cap (25,5 x 94 mm), Nalgene®
14073	
[6]	* BD Vacutainer® (16 x 100 mm), (2,5-11 ml)
[6]	* Greiner Vacuette® (16 x 100 mm), (7-9 ml)
[6]	* Sarstedt S-Monovette® (15 x 92 mm), (7,5; 8,2; 8,5 ml)
[6]	* Sarstedt S-Monovette® (16 x 92 mm), (9; 10 ml)
[6]	15046 14 ml probówka z pokrywką (16,8 x 113,7 mm), Sarstedt® 14 ml tube with cap (16,8 x 113,7 mm), Sarstedt®
[6]	15053 10 ml probówka z pokrywką (16 x 106 mm) 10 ml tube with cap (16 x 106 mm)
[6]	15118 10 ml probówka szklana (16 x 100 mm) 10 ml glass tube (16 x 100 mm)
14089	
[6]	* 15 ml probówka z dnem stożkowym z zakrętką (17 x 120 mm), Falcon®; [15050], 15ml (17 x 120 mm) 15 ml tube, conical bottom, with cap (17 x 120 mm), Falcon®; [15050] 15ml Sarstedt®(17 x 120 mm)
14248	
[6]	15055 30 ml probówka z pokrywką (25,4 x 103,2 mm) 30 ml tube with cap (25,4 x 103,2 mm)
14089+14868	
[6]	* 5 ml probówka z korkiem wciskany (17 x 54,2 mm), Eppendorf® 5 ml tube with snap cap (17 x 54,2 mm), Eppendorf®
[6]	* 5 ml probówka z korkiem zakręcany (17 x 66 mm), Eppendorf® 5 ml tube with screw cap (17 x 66 mm), Eppendorf®
12193	
RPM 4000 RCF 2504 Rmax 140 \pm 90	
13080	
14082	
[8]	* BD Vacutainer® (13 x 100 mm), (4-7 ml)
[8]	* Greiner Vacuette® (13 x 100 mm), (3,5-6 ml)
[8]	* Sarstedt S-Monovette® (11 x 92 mm), (4,5; 5 ml)
[8]	15054 6 ml probówka z pokrywką (11,5 x 92 mm), Sarstedt® 6 ml tube with cap (11,5 x 92 mm), Sarstedt®
[8]	15119 7 ml probówka szklana (12 x 100 mm) 7 ml glass tube (12 x 100 mm)
bez wkładki/without adapter	
[8]	* BD Vacutainer® (16 x 100 mm), (2,5-11 ml)
[8]	* Greiner Vacuette® (16 x 100 mm), (7-9 ml)
[8]	* Sarstedt S-Monovette® (15 x 92 mm), (7,5; 8,2; 8,5 ml)
[8]	* Sarstedt S-Monovette® (16 x 92 mm), (9; 10 ml)
[8]	15046 14 ml probówka z pokrywką (16,8 x 113,7 mm), Sarstedt® 14 ml tube with cap (16,8 x 113,7 mm), Sarstedt®
[8]	15048 15 ml Thermo Nalgene® (16 x 113 mm) 15 ml Thermo Nalgene® (16 x 113 mm)
[8]	15053 10 ml probówka z pokrywką (16 x 106 mm) 10 ml tube with cap (16 x 106 mm)
[8]	15118 10 ml probówka szklana (16 x 100 mm) 10 ml glass tube (16 x 100 mm)
[8]	* 15 ml probówka z dnem stożkowym z zakrętką (17 x 120 mm), Falcon®; [15050], 15ml (17 x 120 mm) 15 ml tube, conical bottom, with cap (17 x 120 mm), Falcon®; [15050] 15ml Sarstedt®(17 x 120 mm)
12193	
RPM 4000 RCF 1968 Rmax 110 \pm 90	
13080	
14082+14815 Rmax 110 RCF 1968	
[8]	* BD Vacutainer® (13 x 75 mm), (1,6-5,3 ml)
[8]	* Greiner Vacuette® (13 x 75 mm), (1-4,5 ml)
[8]	* Sarstedt S-Monovette® (11 x 66 mm), (1,6; 2; 2,7; 3; 3,1 ml)

* probówka niedostępna w ofercie MPW lub dostępny odpowiednik (np.[15050]), patrz kolumna z prawej
tube is not offered by MPW or equivalent is available (e.g. [15050]), see column on the right

A. Wyposażenie dodatkowe/Optional accessories	
MPW M-DIAGNOSTIC	
[8]	* Sarstedt S-Monovette® (13 x 65 mm), (2,6; 2,9; 3,4; 3,8 ml)
[8]	* Sarstedt S-Monovette® (13 x 75 mm), (2,7; 3; 4,3 ml)
[8]	* Sarstedt S-Monovette® (13 x 90 mm), (4,9; 5,6 ml)
[8] 15120	5 ml probówka szklana (12 x 75 mm) 5 ml glass tube (12 x 75 mm)
	14815 Rmax 110 RCF 1968
[8]	* Sarstedt S-Monovette® (15 x 75 mm), (4; 4,3; 5,5 ml)
[8]	* 10 ml Thermo Nalgene® Oak Ridge (16 x 81,5 mm)
[8] 15121	10 ml probówka z dnem okrągłym i pokrywką (17 x 70 mm) 10 ml tube, round bottom, with cap (17 x 70 mm)
12218	
RPM 3000 RCF 916 Rmax 91 ϕ 90	
	13219
	bez wkładki/without adapter
[2] 15102	płytki titracyjna MTP 28,8ml (86x128x15/17,5 mm) microtiter plate MTP 28,8 ml (86 x 128 x 15/17,5 mm)
12452	
RPM 2500 RCF 769 Rmax 110 ϕ 90	
	13606
	bez wkładki/without adapter
[4] 16610	system cytologiczny MPW® 2,2ml cytological system MPW® 2,2 ml
12200	
RPM 4000 RCF 2164 Rmax 121 ϕ 90	
	13113 R max 121 RCF 2164 x g
	bez wkładki/without adapter Rmax 121 RCF 2164
[48]	* BD Vacutainer® (13 x 75 mm), (1,6-5,3 ml)
[48]	* Greiner Vacuette® (13 x 75 mm), (1-4,5 ml)
[48]	* Sarstedt S-Monovette® (11 x 66 mm), (1,6; 2; 2,7; 3; 3,1 ml)
[48]	* Sarstedt S-Monovette® (13 x 65 mm), (2,6; 2,9; 3,4; 3,8 ml)
12200	
RPM 4000 RCF 2504 Rmax 140 ϕ 90	
	13200
	14013
[32]	* BD Vacutainer® (13 x 100 mm), (4-7 ml)
[32]	* Greiner Vacuette® (13 x 100 mm), (3,5-6 ml)
[32]	* Sarstedt S-Monovette® (11 x 92 mm), (4,5; 5 ml)
[32]	* BD Vacutainer® (13 x 75 mm), (1,6-5,3 ml)
[32]	* Greiner Vacuette® (13 x 75 mm), (1-4,5 ml)
[32]	* Sarstedt S-Monovette® (13 x 65 mm), (2,6; 2,9; 3,4; 3,8 ml)
[32]	* Sarstedt S-Monovette® (13 x 75 mm), (2,7; 3; 4,3 ml)
[32]	* Sarstedt S-Monovette® (13 x 90 mm), (4,9; 5,6 ml)
[32] 15054	6 ml probówka z pokrywką (11,5 x 92 mm), Sarstedt® 6 ml tube with cap (11,5 x 92 mm), Sarstedt®
[32] 15119	7 ml probówka szklana (12 x 100 mm) 7 ml glass tube (12 x 100 mm)
[32] 15120	5 ml probówka szklana (12 x 75 mm) 5 ml glass tube (12 x 75 mm)
[32] 15419	5 ml probówka z korkiem (12 x 85 mm), Sarstedt® 5 ml tube with cap (12 x 85 mm), Sarstedt®
	14016
[28]	* Sarstedt S-Monovette® (15 x 75 mm), (4; 4,3; 5,5 ml)
[28]	* BD Vacutainer® (16 x 100 mm), (2,5-11 ml)
[28]	* Greiner Vacuette® (16 x 100 mm), (7-9 ml)
[28]	* Sarstedt S-Monovette® (15 x 92 mm), (7,5; 8,2; 8,5 ml)
[28]	* 10 ml Thermo Nalgene® Oak Ridge (16 x 81,5 mm)
[28] 15053	10 ml probówka z pokrywką (16 x 106 mm) 10 ml tube with cap (16 x 106 mm)
[28] 15118	10 ml probówka szklana (16 x 100 mm) 10 ml glass tube (16 x 100 mm)
[28] 15046	14 ml probówka z pokrywką (16,8 x 113,7 mm), Sarstedt® 14 ml tube with cap (16,8 x 113,7 mm), Sarstedt®

A. Wyposażenie dodatkowe/Optional accessories**MPW M-DIAGNOSTIC****14020**

[20]	*	Sarstedt S-Monovette® (15 x 75 mm), (4; 4,3; 5,5 ml)
[20]	*	10 ml Thermo Nalgene® Oak Ridge (16 x 81,5 mm)
[20]	*	BD Vacutainer® (16 x 100 mm), (2,5-11 ml)
[20]	*	Greiner Vacuette® (16 x 100 mm), (7-9 ml)
[20]	*	Sarstedt S-Monovette® (15 x 92 mm), (7,5; 8,2; 8,5 ml)
[20]	*	Sarstedt S-Monovette® (16 x 92 mm), (9; 10 ml)
[20]	15053	10 ml probówka z pokrywką (16 x 106 mm) 10 ml tube with cap (16 x 106 mm)
[20]	15118	10 ml probówka szklana (16 x 100 mm) 10 ml glass tube (16 x 100 mm)
[20]	*	13 ml probówka (ø16x100mm), Sarstedt® nr 62.515.006 13 ml tube (ø16 x 100 mm), Sarstedt® no. 62.515.006
[20]	15046	14 ml probówka z pokrywką (16,8 x 113,7 mm), Sarstedt® 14 ml tube with cap (16,8 x 113,7 mm), Sarstedt®
[20]	15121	10 ml probówka z dnem okrągłym i pokrywką (17 x 70 mm) 10 ml tube, round bottom, with cap (17 x 70 mm)

14021

[40]	*	2-1,5 ml probówka (10,8x41,8 mm), Eppendorf®; [15011], 2 ml (10,8x41,8 mm); [15128], 1,5ml (10,8x40,5 mm) 2-1,5 ml tube (10,8x41,8 mm), Eppendorf®; [15011], 2 ml (10,8x41,8 mm); [15128], 1,5ml (10,8x40,5 mm)
[40]	*	2 ml probówki z filtrem - spin columns (10,8 x 46 mm) 2 ml spin columns (with filter) (10,8 x 46 mm); [15011], 2 ml (10,8x41,8 mm); [15128], 1,5ml (10,8x40,5 mm)

14023

[4]	*	28 ml Thermo Nalgene® Oak Ridge (25,4 x 101,8 mm)
[4]	15056	30 ml Thermo Nalgene® Oak Ridge (25,5 x 94,3 mm) 30 ml Thermo Nalgene® Oak Ridge (25,5 x 94,3 mm)
[4]	15055	30 ml probówka z pokrywką (25,4 x 103,2 mm) 30 ml tube with cap (25,4 x 103,2 mm)
[4]	15222	30 ml probówka z pokrywką (25 x 94mm), Sterilin® 30 ml tube with cap (25 x 94 mm), Sterilin®
[4]	15223	30 ml probówka z pokrywką (25 x 94 mm), Sterilin® 30 ml tube with cap (25 x 94 mm), Sterilin®
[4]	15117	25 ml probówka szklana (25 x 100 mm) 25 ml glass tube (25 x 100 mm)
[4]	15424	30 ml probówka z pokrywką (25,5 x 94 mm), Nalgene® 30 ml tube with cap (25,5 x 94 mm), Nalgene®

14026

[4]	*	50 ml probówka z dnem stożkowym z rantem (30 x 115 mm), Greiner® 50 ml tube, conical bottom, skirted (30 x 115 mm), Greiner®
-----	---	---

14026+14188

[4]	15051	50 ml Thermo Nalgene® Oak Ridge (28,8 x 106,7 mm) 50 ml Thermo Nalgene® Oak Ridge (28,8 x 106,7 mm)
[4]	*	50 ml probówka z dnem stożkowym z zakrętką (30 x 117 mm), Falcon®; [15052] 50ml (30 x 117mm) 50 ml tube, conical bottom, with cap (30 x 117 mm), Falcon®; [15052] 50ml Sarstedt® (30 x 117 mm)
[4]	*	50 ml probówka z dnem stożkowym bez rantu (30 x 115 mm), Greiner® 50 ml tube, conical bottom, without skirt (30 x 115 mm), Greiner®
[4]	*	50 ml probówka Advanced Oak Ridge (29x102 mm), Herolab® nr 25 32 11 50 ml tube, Advanced Oak Ridge (29 x 102 mm), Herolab® no. 25 32 11

14028

[4]	15116	50 ml probówka szklana (35 x 100 mm) 50 ml glass tube (35 x 100 mm)
-----	-------	--

14029

[48]	*	Sarstedt S-Monovette® (11 x 92 mm), (4,5; 5 ml)
[48]	*	Sarstedt S-Monovette® (11 x 66 mm), (1,6; 2; 2,7; 3; 3,1 ml)
[48]	15054	6 ml probówka z pokrywką (11,5 x 92 mm), Sarstedt® 6 ml tube with cap (11,5 x 92 mm), Sarstedt®
[48]	15119	7 ml probówka szklana (12 x 100 mm) 7 ml glass tube (12 x 100 mm)
[48]	15120	5 ml probówka szklana (12 x 75 mm) 5 ml glass tube (12 x 75 mm)
[48]	15419	5 ml probówka z korkiem (12 x 85 mm), Sarstedt® 5 ml tube with cap (12 x 85 mm), Sarstedt®

14100+14196

[4]	15040	100 ml probówka z pokrywką (45,2 x 103,7 mm) 100 ml tube with cap (45,2 x 103,7 mm)
-----	-------	--

14100+14188

[4]	15115	100 ml probówka szklana (44 x 100 mm) 100 ml glass tube (44 x 100 mm)
-----	-------	--

14027

[4]	*	15 ml probówka z dnem stożkowym z zakrętką (17 x 120 mm), Falcon®; [15050], 15ml (17 x 120 mm) 15 ml tube, conical bottom, with cap (17 x 120 mm), Falcon®; [15050] 15ml Sarstedt®(17 x 120 mm)
-----	---	--

A. Wyposażenie dodatkowe/Optional accessories**MPW M-DIAGNOSTIC**

13201+17202

14013

[32]	*	BD Vacutainer® (13 x 100 mm), (4-7 ml)
[32]	*	Greiner Vacuette® (13 x 100 mm), (3,5-6 ml)
[32]	*	Sarstedt S-Monovette® (11 x 92 mm), (4,5; 5 ml)
[32]	*	BD Vacutainer® (13 x 75 mm), (1,6-5,3 ml)
[32]	*	Greiner Vacuette® (13 x 75 mm), (1-4,5 ml)
[32]	*	Sarstedt S-Monovette® (13 x 65 mm), (2,6; 2,9; 3,4; 3,8 ml)
[32]	*	Sarstedt S-Monovette® (13 x 75 mm), (2,7; 3; 4,3 ml)
[32]	*	Sarstedt S-Monovette® (13 x 90 mm), (4,9; 5,6 ml)
[32]	15054	6 ml probówka z pokrywką (11,5 x 92 mm), Sarstedt® 6 ml tube with cap (11,5 x 92 mm), Sarstedt®
[32]	15119	7 ml probówka szklana (12 x 100 mm) 7 ml glass tube (12 x 100 mm)
[32]	15120	5 ml probówka szklana (12 x 75 mm) 5 ml glass tube (12 x 75 mm)
[32]	15419	5 ml probówka z korkiem (12 x 85 mm), Sarstedt® 5 ml tube with cap (12 x 85 mm), Sarstedt®

14016

[28]	*	Sarstedt S-Monovette® (15 x 75 mm), (4; 4,3; 5,5 ml)
[28]	*	BD Vacutainer® (16 x 100 mm), (2,5-11 ml)
[28]	*	Greiner Vacuette® (16 x 100 mm), (7-9 ml)
[28]	*	10 ml Thermo Nalgene® Oak Ridge (16 x 81,5 mm)
[28]	15053	10 ml probówka z pokrywką (16 x 106 mm) 10 ml tube with cap (16 x 106 mm)
[28]	15118	10 ml probówka szklana (16 x 100 mm) 10 ml glass tube (16 x 100 mm)
[28]	15046	14 ml probówka z pokrywką (16,8 x 113,7 mm), Sarstedt® 14 ml tube with cap (16,8 x 113,7 mm), Sarstedt®

14020

[20]	*	Sarstedt S-Monovette® (15 x 75 mm), (4; 4,3; 5,5 ml)
[20]	*	10 ml Thermo Nalgene® Oak Ridge (16 x 81,5 mm)
[20]	*	BD Vacutainer® (16 x 100 mm), (2,5-11 ml)
[20]	*	Greiner Vacuette® (16 x 100 mm), (7-9 ml)
[20]	15053	10 ml probówka z pokrywką (16 x 106 mm) 10 ml tube with cap (16 x 106 mm)
[20]	15118	10 ml probówka szklana (16 x 100 mm) 10 ml glass tube (16 x 100 mm)
[20]	*	13 ml probówka (Ø16x100mm), Sarstedt® nr 62.515.006 13 ml tube (Ø16 x 100 mm), Sarstedt® no. 62.515.006
[20]	15046	14 ml probówka z pokrywką (16,8 x 113,7 mm), Sarstedt® 14 ml tube with cap (16,8 x 113,7 mm), Sarstedt®
[20]	15121	10 ml probówka z dnem okrągłym i pokrywką (17 x 70 mm) 10 ml tube, round bottom, with cap (17 x 70 mm)

14021

[40]	*	2-1,5 ml probówka (10,8x41,8 mm), Eppendorf®; [15011], 2 ml (10,8x41,8 mm); [15128], 1,5ml (10,8x40,5 mm) 2-1,5 ml tube (10,8x41,8 mm), Eppendorf®; [15011], 2 ml (10,8x41,8 mm); [15128], 1,5ml (10,8x40,5 mm)
[40]	*	2 ml probówki z filtrem - spin columns (10,8 x 46 mm) 2 ml spin columns (with filter) (10,8 x 46 mm); [15011], 2 ml (10,8x41,8 mm); [15128], 1,5ml (10,8x40,5 mm)

14023

[4]	*	28 ml Thermo Nalgene® Oak Ridge (25,4 x 101,8 mm)
[4]	15056	30 ml Thermo Nalgene® Oak Ridge (25,5 x 94,3 mm) 30 ml Thermo Nalgene® Oak Ridge (25,5 x 94,3 mm)
[4]	15055	30 ml probówka z pokrywką (25,4 x 103,2 mm) 30 ml tube with cap (25,4 x 103,2 mm)
[4]	15222	30 ml probówka z pokrywką (25 x 94mm), Sterilin® 30 ml tube with cap (25 x 94 mm), Sterilin®
[4]	15223	30 ml probówka z pokrywką (25 x 94 mm), Sterilin® 30 ml tube with cap (25 x 94 mm), Sterilin®
[4]	15117	25 ml probówka szklana (25 x 100 mm) 25 ml glass tube (25 x 100 mm)
[4]	15424	30 ml probówka z pokrywką (25,5 x 94 mm), Nalgene® 30 ml tube with cap (25,5 x 94 mm), Nalgene®

14026+14188

[4]	15051	50 ml Thermo Nalgene® Oak Ridge (28,8 x 106,7 mm) 50 ml Thermo Nalgene® Oak Ridge (28,8 x 106,7 mm)
-----	-------	--

14028

[4]	15116	50 ml probówka szklana (35 x 100 mm) 50 ml glass tube (35 x 100 mm)
-----	-------	--

A. Wyposażenie dodatkowe/Optional accessories	
MPW M-DIAGNOSTIC	
14029	
[48]	* Sarstedt S-Monovette® (11 x 66 mm), (1,6; 2; 2,7; 3; 3,1 ml)
[48]	15054 6 ml probówka z pokrywką (11,5 x 92 mm), Sarstedt® 6 ml tube with cap (11,5 x 92 mm), Sarstedt®
[48]	15119 7 ml probówka szklana (12 x 100 mm) 7 ml glass tube (12 x 100 mm)
[48]	15120 5 ml probówka szklana (12 x 75 mm) 5 ml glass tube (12 x 75 mm)
[48]	15419 5 ml probówka z korkiem (12 x 85 mm), Sarstedt® 5 ml tube with cap (12 x 85 mm), Sarstedt®
14100+14196	
[4]	15040 100 ml probówka z pokrywką (45,2 x 103,7 mm) 100 ml tube with cap (45,2 x 103,7 mm)
14100+14188	
[4]	15115 100 ml probówka szklana (44 x 100 mm) 100 ml glass tube (44 x 100 mm)
13201+17203	
14021	
[40]	* 2-1,5 ml probówka (10,8x41,8 mm), Eppendorf®; [15011], 2 ml (10,8x41,8 mm); [15128], 1,5ml (10,8x40,5 mm) 2-1,5 ml tube (10,8x41,8 mm), Eppendorf®; [15011], 2 ml (10,8x41,8 mm); [15128], 1,5ml (10,8x40,5 mm)
[40]	* 2 ml probówki z filtrem - spin columns (10,8 x 46 mm) 2 ml spin columns (with filter) (10,8 x 46 mm); [15011], 2 ml (10,8x41,8 mm); [15128], 1,5ml (10,8x40,5 mm)
14026	
[4]	* 50 ml probówka z dnem stożkowym z rantem (30 x 115 mm), Greiner® 50 ml tube, conical bottom, skirted (30 x 115 mm), Greiner®
14026+14188	
[4]	15051 50 ml Thermo Nalgene® Oak Ridge (28,8 x 106,7 mm) 50 ml Thermo Nalgene® Oak Ridge (28,8 x 106,7 mm)
[4]	* 50 ml probówka z dnem stożkowym z zakrętką (30 x 117 mm), Falcon®; [15052] 50ml (30 x 117mm) 50 ml tube, conical bottom, with cap (30 x 117 mm), Falcon®; [15052] 50ml Sarstedt® (30 x 117 mm)
[4]	* 50 ml probówka z dnem stożkowym bez rantu (30 x 115 mm), Greiner® 50 ml tube, conical bottom, without skirt (30 x 115 mm), Greiner®
[4]	* 50 ml probówka Advanced Oak Ridge (29x102 mm), Herolab® nr 25 32 11 50 ml tube, Advanced Oak Ridge (29 x 102 mm), Herolab® no. 25 32 11
14028	
[4]	15116 50 ml probówka szklana (35 x 100 mm) 50 ml glass tube (35 x 100 mm)
14100+14196	
[4]	15040 100 ml probówka z pokrywką (45,2 x 103,7 mm) 100 ml tube with cap (45,2 x 103,7 mm)
14100+14188	
[4]	15115 100 ml probówka szklana (44 x 100 mm) 100 ml glass tube (44 x 100 mm)
14027	
[4]	* 15 ml probówka z dnem stożkowym z zakrętką (17 x 120 mm), Falcon®; [15050], 15ml (17 x 120 mm) 15 ml tube, conical bottom, with cap (17 x 120 mm), Falcon®; [15050] 15ml Sarstedt®(17 x 120 mm)
12200	
RPM 4000 RCF 2469 Rmax 138 α 90	
13215 R max 138 RCF 2469 x g	
bez wkładki/without adapter Rmax 138 RCF 2469	
[8]	* BD Vacutainer® (16 x 100 mm), (2,5-11 ml)
[8]	* Greiner Vacuette® (16 x 100 mm), (7-9 ml)
[8]	* Sarstedt S-Monovette® (15 x 92 mm), (7,5; 8,2; 8,5 ml)
[8]	* Sarstedt S-Monovette® (16 x 92 mm), (9; 10 ml)
[8]	15046 14 ml probówka z pokrywką (16,8 x 113,7 mm), Sarstedt® 14 ml tube with cap (16,8 x 113,7 mm), Sarstedt®
[8]	15048 15 ml Thermo Nalgene® (16 x 113 mm) 15 ml Thermo Nalgene® (16 x 113 mm)
[8]	15053 10 ml probówka z pokrywką (16 x 106 mm) 10 ml tube with cap (16 x 106 mm)
[8]	15118 10 ml probówka szklana (16 x 100 mm) 10 ml glass tube (16 x 100 mm)
[8]	* 15 ml probówka z dnem stożkowym z zakrętką (17 x 120 mm), Falcon®; [15050], 15ml (17 x 120 mm) 15 ml tube, conical bottom, with cap (17 x 120 mm), Falcon®; [15050] 15ml Sarstedt®(17 x 120 mm)
14082 Rmax 138 RCF 2469	
[8]	* BD Vacutainer® (13 x 100 mm), (4-7 ml)
[8]	* Greiner Vacuette® (13 x 100 mm), (3,5-6 ml)
[8]	* Sarstedt S-Monovette® (11 x 92 mm), (4,5; 5 ml)

* probówka niedostępna w ofercie MPW lub dostępny odpowiednik (np:[15050]), patrz kolumna z prawej
tube is not offered by MPW or equivalent is available (e.g. [15050]), see column on the right

A. Wyposażenie dodatkowe/Optional accessories	
MPW M-DIAGNOSTIC	
[8]	15054 6 ml probówka z pokrywką (11,5 x 92 mm), Sarstedt® 6 ml tube with cap (11,5 x 92 mm), Sarstedt®
[8]	15119 7 ml probówka szklana (12 x 100 mm) 7 ml glass tube (12 x 100 mm)
11501	
RPM 4500 RCF 2966 Rmax 131 \pm 30	
13080 R max 131 RCF 2966 x g	
14082 Rmax 131 RCF 2966	
[30]	* BD Vacutainer® (13 x 100 mm), (4-7 ml)
[30]	* Greiner Vacuette® (13 x 100 mm), (3,5-6 ml)
[30]	* Sarstedt S-Monovette® (11 x 92 mm), (4,5; 5 ml)
[30]	15054 6 ml probówka z pokrywką (11,5 x 92 mm), Sarstedt® 6 ml tube with cap (11,5 x 92 mm), Sarstedt®
[30]	15119 7 ml probówka szklana (12 x 100 mm) 7 ml glass tube (12 x 100 mm)
bez wkładki/without adapter Rmax 131 RCF 2966	
[30]	* BD Vacutainer® (16 x 100 mm), (2,5-11 ml)
[30]	* Greiner Vacuette® (16 x 100 mm), (7-9 ml)
[30]	* Sarstedt S-Monovette® (15 x 92 mm), (7,5; 8,2; 8,5 ml)
[30]	* Sarstedt S-Monovette® (16 x 92 mm), (9; 10 ml)
[30]	15046 14 ml probówka z pokrywką (16,8 x 113,7 mm), Sarstedt® 14 ml tube with cap (16,8 x 113,7 mm), Sarstedt®
[30]	15048 15 ml Thermo Nalgene® (16 x 113 mm) 15 ml Thermo Nalgene® (16 x 113 mm)
[30]	15053 10 ml probówka z pokrywką (16 x 106 mm) 10 ml tube with cap (16 x 106 mm)
[30]	15118 10 ml probówka szklana (16 x 100 mm) 10 ml glass tube (16 x 100 mm)
[30]	* 15 ml probówka z dnem stożkowym z zakrętką (17 x 120 mm), Falcon®; [15050], 15ml (17 x 120 mm) 15 ml tube, conical bottom, with cap (17 x 120 mm), Falcon®; [15050] 15ml Sarstedt®(17 x 120 mm)
11743	
RPM 5500 RCF 3889 Rmax 115 \pm 30	
13329	
bez wkładki/without adapter	
[12]	15055 30 ml probówka z pokrywką (25,4 x 103,2 mm) 30 ml tube with cap (25,4 x 103,2 mm)
[12]	15424 30 ml probówka z pokrywką (25,5 x 94 mm), Nalgene® 30 ml tube with cap (25,5 x 94 mm), Nalgene®
[12]	15222 30 ml probówka z pokrywką (25 x 94mm), Sterilin® 30 ml tube with cap (25 x 94 mm), Sterilin®
[12]	15223 30 ml probówka z pokrywką (25 x 94 mm), Sterilin® 30 ml tube with cap (25 x 94 mm), Sterilin®
14256	
[12]	15046 14 ml probówka z pokrywką (16,8 x 113,7 mm), Sarstedt® 14 ml tube with cap (16,8 x 113,7 mm), Sarstedt®
[12]	15048 15 ml Thermo Nalgene® (16 x 113 mm) 15 ml Thermo Nalgene® (16 x 113 mm)
[12]	15053 10 ml probówka z pokrywką (16 x 106 mm) 10 ml tube with cap (16 x 106 mm)
[12]	15118 10 ml probówka szklana (16 x 100 mm) 10 ml glass tube (16 x 100 mm)
14255	
[12]	* Sarstedt S-Monovette® (11 x 92 mm), (4,5; 5 ml)
[12]	15119 7 ml probówka szklana (12 x 100 mm) 7 ml glass tube (12 x 100 mm)
Suma końcowa	

A. Wyposażenie dodatkowe/Optional accessories
MPW M-SCIENCE
WIRNIK / ROTOR

 PARAMETRY WIRNIKA / ROTOR PARAMETERS (RCF [x g], Rmax [mm], α [°])

POJEMNIK/BUCKET

WKŁADKA / ADAPTER

[liczba probówek na wirnik/tubes per rotor] PROBÓWKA / TUBE

11199
RPM 18000 RCF 24270 Rmax 67 α 45

bez pojemnika/without bucket

bez wkładki/without adapter

 [12] * 2-1,5 ml probówka (10,8x41,8 mm), Eppendorf®; [15011], 2 ml (10,8x41,8 mm); [15128], 1,5ml (10,8x40,5 mm)
 2-1,5 ml tube (10,8x41,8 mm), Eppendorf®; [15011], 2 ml (10,8x41,8 mm); [15128], 1,5ml (10,8x40,5 mm)

14084

 [12] 15127 0,5 ml probówka PCR (7,8 x 31 mm)
 0,5 ml PCR tube (7,8 x 31 mm)

14126

 [12] 15124 0,4 ml probówka PCR (5,7 x 48,6 mm)
 0,4 ml PCR tube (5,7 x 48,6 mm)

14133

 [12] 15125 0,2 ml probówka PCR (6 x 21,6 mm)
 0,2 ml PCR tube (6 x 21,6 mm)

11461
RPM 15100 RCF 21158 Rmax 83 α 45

bez pojemnika/without bucket R max 83 RCF 21158 x g

14084 Rmax 83 RCF 21158

 [24] 15127 0,5 ml probówka PCR (7,8 x 31 mm)
 0,5 ml PCR tube (7,8 x 31 mm)

14126 Rmax 83 RCF 21158

 [24] 15124 0,4 ml probówka PCR (5,7 x 48,6 mm)
 0,4 ml PCR tube (5,7 x 48,6 mm)

14133 Rmax 83 RCF 21158

 [24] 15125 0,2 ml probówka PCR (6 x 21,6 mm)
 0,2 ml PCR tube (6 x 21,6 mm)

bez wkładki/without adapter Rmax 83 RCF 21158

 [24] * 2-1,5 ml probówka (10,8x41,8 mm), Eppendorf®; [15011], 2 ml (10,8x41,8 mm); [15128], 1,5ml (10,8x40,5 mm)
 2-1,5 ml tube (10,8x41,8 mm), Eppendorf®; [15011], 2 ml (10,8x41,8 mm); [15128], 1,5ml (10,8x40,5 mm)

11462
RPM 14000 RCF 18188 Rmax 83 α 45

bez pojemnika/without bucket R max 83 RCF 18188 x g

14084 Rmax 83 RCF 18188

 [36] 15127 0,5 ml probówka PCR (7,8 x 31 mm)
 0,5 ml PCR tube (7,8 x 31 mm)

14126 Rmax 83 RCF 18188

 [36] 15124 0,4 ml probówka PCR (5,7 x 48,6 mm)
 0,4 ml PCR tube (5,7 x 48,6 mm)

14133 Rmax 83 RCF 18188

 [36] 15125 0,2 ml probówka PCR (6 x 21,6 mm)
 0,2 ml PCR tube (6 x 21,6 mm)

bez wkładki/without adapter Rmax 83 RCF 18188

 [36] * 2-1,5 ml probówka (10,8x41,8 mm), Eppendorf®; [15011], 2 ml (10,8x41,8 mm); [15128], 1,5ml (10,8x40,5 mm)
 2-1,5 ml tube (10,8x41,8 mm), Eppendorf®; [15011], 2 ml (10,8x41,8 mm); [15128], 1,5ml (10,8x40,5 mm)

11715
RPM 14000 RCF 15558 Rmax 71 α 30

bez pojemnika/without bucket

bez wkładki/without adapter

 [10] 15121 10 ml probówka z dnem okrągłym i pokrywką (17 x 70 mm)
 10 ml tube, round bottom, with cap (17 x 70 mm)

A. Wyposażenie dodatkowe/Optional accessories	
MPW M-SCIENCE	
11716	
RPM 14000 RCF 15339 Rmax 70 \neq 45	
bez pojemnika/without bucket R max 70 RCF 15339 x g	
bez wkładki/without adapter Rmax 70 RCF 15339	
[4]	15131 4 x 0,2 ml probówki szeregowe PCR-strip (10,2 x 37,2 mm) 4 x 0,2 ml PCR strip (10,2 x 37,2 mm)
[4]	15122 8 x 0,2 ml probówki szeregowe PCR-strip (10,2 x 72,4 mm) 8 x 0,2 ml PCR strip (10,2 x 72,4 mm)
[32]	15125 0,2 ml probówka PCR (6 x 21,6 mm) 0,2 ml PCR tube (6 x 21,6 mm)
[4]	15130 8 x 0,2 ml probówki szeregowe PCR strip (7,3 x 77,2 mm) 8 x 0,2 ml PCR strip (7,3 x 77,2 mm)
11760	
RPM 13500 RCF 17319 Rmax 85 \neq 45	
bez pojemnika/without bucket R max 85 RCF 17319 x g	
14084 Rmax 85 RCF 17319	
[24]	15127 0,5 ml probówka PCR (7,8 x 31 mm) 0,5 ml PCR tube (7,8 x 31 mm)
14126 Rmax 85 RCF 17319	
[24]	15124 0,4 ml probówka PCR (5,7 x 48,6 mm) 0,4 ml PCR tube (5,7 x 48,6 mm)
14133 Rmax 85 RCF 17319	
[24]	15125 0,2 ml probówka PCR (6 x 21,6 mm) 0,2 ml PCR tube (6 x 21,6 mm)
bez wkładki/without adapter Rmax 85 RCF 17319	
[24]	* 2-1,5 ml probówka (10,8x41,8 mm), Eppendorf®; [15011], 2 ml (10,8x41,8 mm); [15128], 1,5ml (10,8x40,5 mm) 2-1,5 ml tube (10,8x41,8 mm), Eppendorf®; [15011], 2 ml (10,8x41,8 mm); [15128], 1,5ml (10,8x40,5 mm)
[24]	* 2 ml probówki z filtrem - spin columns (10,8 x 46 mm) 2 ml spin columns (with filter) (10,8 x 46 mm); [15011], 2 ml (10,8x41,8 mm); [15128], 1,5ml (10,8x40,5 mm)
11943	
RPM 12000 RCF 13684 Rmax 85 \neq 45	
bez pojemnika/without bucket R max 85 RCF 13684 x g	
bez wkładki/without adapter Rmax 85 RCF 13684	
[20]	* 1,6 ml probówka Cryo (12,3 x 46,5 mm) 1,6 ml Cryo tube (12,3 x 46,5 mm)
[20]	* 1,8 ml probówka Cryo (12,3 x 46,5 mm) 1,8 ml Cryo tube (12,3 x 46,5 mm)
11944	
RPM 12000 RCF 13684 Rmax 85 \neq 45	
bez pojemnika/without bucket R max 85 RCF 13684 x g	
bez wkładki/without adapter Rmax 85 RCF 13684	
[6]	* 5 ml probówka z korkiem zakręcanym (17 x 66 mm), Eppendorf® 5 ml tube with screw cap (17 x 66 mm), Eppendorf®
[12]	* 5 ml probówka z korkiem wciskany (17 x 54,2 mm), Eppendorf® 5 ml tube with snap cap (17 x 54,2 mm), Eppendorf®
12300	
RPM 13000 RCF 16816 Rmax 89 \neq 90	
bez pojemnika/without bucket	
bez wkładki/without adapter	
[24]	15100 37 μ l kapilarna hematocrytowa (1,4 x 75 mm) 37 μ l micro-hematocrit capillary tube (1,4 x 75 mm)
Suma końcowa	

EU DECLARATION OF CONFORMITY

This EU declaration of conformity is issued under the sole responsibility of the manufacturer.

Manufacturer: **"MPW MED. INSTRUMENTS" SPÓŁDZIELNIA PRACY**
46 Boremłowska Street, 04-347 Warsaw, Poland

We apply the certified
Quality Management System
in accordance
with the standards: PN-EN ISO 9001:2015, PN-EN ISO 13485:2016

Product name: **Laboratory centrifuge MPW M-UNIVERSAL**

The aforementioned product is in conformity with the following EU regulations and directives:

- **2017/746 (IVDR)** REGULATION (EU) 2017/746 OF THE EUROPEAN PARLIAMENT AND OF THE COUNCIL of 5 April 2017 on in vitro diagnostic medical devices and repealing Directive 98/79/EC and Commission Decision 2010/227/EU
- **2011/65/UE (RoHS 2)** DIRECTIVE 2011/65/EU OF THE EUROPEAN PARLIAMENT AND OF THE COUNCIL of 8 June 2011 on the restriction of the use of certain hazardous substances in electrical and electronic equipment

Intended purpose: The product is a benchtop laboratory centrifuge specifically intended by the manufacturer for in vitro diagnostic (IVD) procedures. It is used for the separation of mixtures, suspensions, body fluids into components of different density under the influence of centrifugal force.

Risk class: **Class A (in accordance with Annex VIII, rule 5)**

The assessment of the conformity of the device has been carried out in accordance with Article 48(10) of Regulation (EU) 2017/746.

Wojciech Anisiewicz
Vice-President of the Management Board

Łukasz Sałański
President of the Management Board

EU DECLARATION OF CONFORMITY

This EU declaration of conformity is issued under the sole responsibility of the manufacturer.

Manufacturer: **"MPW MED. INSTRUMENTS" SPÓŁDZIELNIA PRACY**
46 Boremłowska Street, 04-347 Warsaw, Poland

We apply the certified
Quality Management System
in accordance
with the standards: PN-EN ISO 9001:2015, PN-EN ISO 13485:2016

Product name: **Laboratory centrifuge MPW M-DIAGNOSTIC**

The aforementioned product is in conformity with the following EU regulations and directives:

- **2017/746 (IVDR)** REGULATION (EU) 2017/746 OF THE EUROPEAN PARLIAMENT AND OF THE COUNCIL of 5 April 2017 on in vitro diagnostic medical devices and repealing Directive 98/79/EC and Commission Decision 2010/227/EU
- **2011/65/UE (RoHS 2)** DIRECTIVE 2011/65/EU OF THE EUROPEAN PARLIAMENT AND OF THE COUNCIL of 8 June 2011 on the restriction of the use of certain hazardous substances in electrical and electronic equipment

Intended purpose: The product is a benchtop laboratory centrifuge specifically intended by the manufacturer for in vitro diagnostic (IVD) procedures. It is used for the separation of mixtures, suspensions, body fluids into components of different density under the influence of centrifugal force.

Risk class: **Class A (in accordance with Annex VIII, rule 5)**

The assessment of the conformity of the device has been carried out in accordance with Article 48(10) of Regulation (EU) 2017/746.

Wojciech Anisiewicz
Vice-President of the Management Board

Łukasz Sałański
President of the Management Board

EU DECLARATION OF CONFORMITY

This EU declaration of conformity is issued under the sole responsibility of the manufacturer.

Manufacturer: **"MPW MED. INSTRUMENTS" SPÓŁDZIELNIA PRACY**
46 Boremlowska Street, 04-347 Warsaw, Poland

We apply the certified
Quality Management System
in accordance
with the standards: PN-EN ISO 9001:2015, PN-EN ISO 13485:2016

Product name: **Laboratory centrifuge MPW M-SCIENCE**

The aforementioned product is in conformity with the following EU regulations and directives:

- **2017/746 (IVDR)** REGULATION (EU) 2017/746 OF THE EUROPEAN PARLIAMENT AND OF THE COUNCIL of 5 April 2017 on in vitro diagnostic medical devices and repealing Directive 98/79/EC and Commission Decision 2010/227/EU
- **2011/65/UE (RoHS 2)** DIRECTIVE 2011/65/EU OF THE EUROPEAN PARLIAMENT AND OF THE COUNCIL of 8 June 2011 on the restriction of the use of certain hazardous substances in electrical and electronic equipment

Intended purpose: The product is a benchtop laboratory centrifuge specifically intended by the manufacturer for in vitro diagnostic (IVD) procedures. It is used for the separation of mixtures, suspensions, body fluids into components of different density under the influence of centrifugal force.

Risk class: **Class A (in accordance with Annex VIII, rule 5)**

The assessment of the conformity of the device has been carried out in accordance with Article 48(10) of Regulation (EU) 2017/746.

Wojciech Anisiewicz
Vice-President of the Management Board

Łukasz Sałański
President of the Management Board

DECLARATION OF DECONTAMINATION

(repair)

In order to protect our employees please fill out the declaration of decontamination completely before sending centrifuge to the manufacturer (repair).

1. Device:

– type:

– serial No.:

2. Description of decontamination

(see user manual)

.....

.....

.....

.....

3. Decontamination carried out by:

name:

4. Date and signature:

.....

DECLARATION OF DECONTAMINATION

(return)

In order to protect our employees please fill out the declaration of decontamination completely before sending centrifuge to the manufacturer (return).

1. Device:

– type:

– serial No.:

2. Description of decontamination

(see user manual)

.....
.....
.....
.....

3. Decontamination carried out by:

name:

4. Date and signature:

.....

NOMOGRAM

Centrifuging radius [cm]

R.C.F. (x "g")
multiple of
gravitational
acceleration

[r.p.m.]

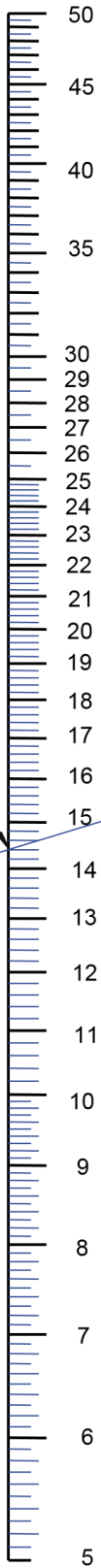

Formula used for calculation of this nomogram :

$$R.C.F. = 11,18 * r * (n/1000)^2$$

where :

- R.C.F. - multiple of gravitational acceleration
- r - centrifuging radius (cm)
- n - rotational speed (r.p.m.)
- g - gravitational acceleration

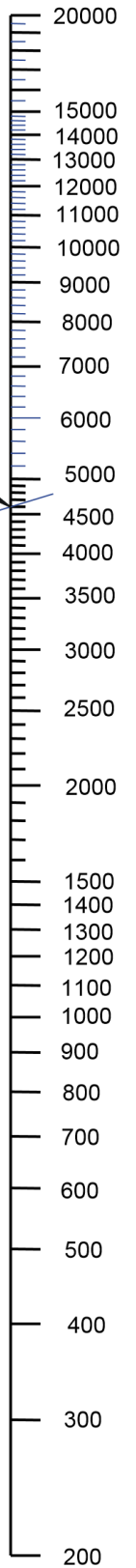
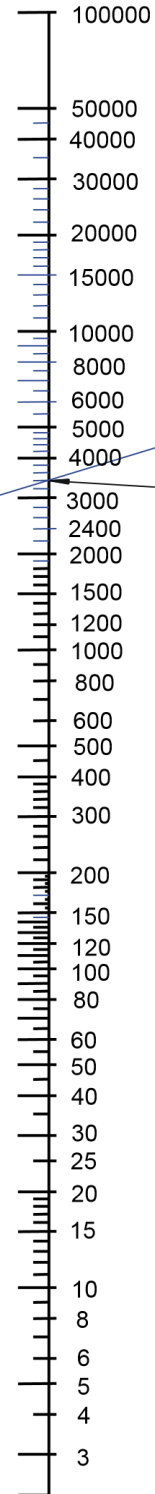

A

B

C

Example of making use
of the nomogram:

- A=14,4 cm
- B=4600 r.p.m.
- C=3400 x g

$$n = 1000 * \sqrt{\frac{RCF}{(11,18 * r)}}$$

$$r = \frac{RCF}{\left[11,18 * \left(\frac{n}{1000} \right)^2 \right]}$$