

USER MANUAL



Laboratory centrifuge **MPW-55**

Read before use!





Serial number of the centrifuge:

This manual was prepared with special care. MPW MED. INSTRUMENTS may change the manual at any time and without notice because of improvements, typographical errors or improvements to facilities

All rights reserved. No part of this User Manual may be modified, distributed, published or reproduced without the prior permission of MPW MED. INSTRUMENTS.

You can find the current version of the user manual on our website under:
www.mpw.pl DOWNLOAD section (one should choose demanded language version of website).

Warning signs:

	WARNING! Warning of potential injury or health risk.
	DANGER! Risk of electric shock with potential for severe injury or death as a consequence.
	DANGER! Biohazard with potential for risk to health or death as a consequence.
	DANGER! Risk of explosion with potential for severe injury or death as a consequence.

Contents

2. TECHNICAL DATA.	5
3. INSTALLATION.	6
3.1. BASIC ACCESSORIES (BEING ENCLOSED TO EVERY CENTRIFUGE).	6
3.2. OTHER ACCESSORIES	6
3.3. EXPLOITATION MATERIALS.	6
3.4. UNBOXING.	6
3.5. LOCATION.	6
3.6. CONNECTION TO MAINS.	6
3.7. FUSES.	6
4. DESCRIPTION OF THE CENTRIFUGE.	7
4.1. GENERAL DESCRIPTION.	7
4.2. SERVICE ELEMENTS.	7
5. SAFE WORKING CONDITIONS.	8
5.1. SERVICING PERSONNEL.	8
5.2. GUARANTEE AND OPERATIONAL USE PERIOD.	8
5.3. SAFEKEEPING PERIOD.	8
5.4. HINTS ON CENTRIFUGING.	8
5.5. HAZARDS AND PRECAUTIONS	9
6. OPERATION OF THE CENTRIFUGE.	10
6.1. MOUNTING OF THE ROTOR AND ACCESSORIES.	10
6.2. CONSTRUCTION AND SAFETY MEASURES.	10
6.3. DRIVE.	10
6.4. DATA INPUT AND OUTPUT.	10
6.5. CONTROLS.	10
6.6. SAFETY DEVICES.	11
6.6.1. COVER LOCK.	11
6.6.2. UNBALANCED LOAD CHECKING SYSTEM.	11
6.6.3. REST STATE INSPECTION.	11
6.7. INCREASE A TEMPERATURE	11
7. DESCRIPTION OF THE CENTRIFUGE OPERATING ELEMENTS.	12
7.1. CONTROL PANEL - DRAWING NO. 4.	12
7.2. SWITCHING THE CENTRIFUGE ON.	14
7.3. SWITCHING THE CENTRIFUGE OFF.	15
7.4. MATHEMATICAL RELATIONS.	15
7.4.1. RCF – RELATIVE CENTRIPETAL FORCE.	15
7.4.2. NOMOGRAM OF RELATIONSHIP - ROTATIONAL SPEED/CENTRIFUGING RADIUS/RCF – ATTACHMENT	15
7.4.3. MAXIMUM LOAD.	15
8. CLEANING, DISINFECTION, MAINTENANCE.	16
8.1. CLEANING OF THE CENTRIFUGE.	16
8.2. CLEANING OF THE ACCESSORIES.	16
8.3. STERILIZATION AND DISINFECTIONS OF THE ROTATIONAL CHAMBER AND ACCESSORIES.	16
9. EMERGENCY CONDITIONS – SERVICE.	18
9.1. FAULT FINDING.	18
9.2. WORK SAFETY INSPECTION.	19
9.3. INSPECTION PROCEDURES CARRIED OUT BY THE OPERATOR.	19
10. REPAIR CONDITIONS.	20
11. TRANSPORT AND STORAGE	21
12. DISPOSAL.	22
13. MANUFACTURER’S DATA.	23
14. TABLE OF CHEMICAL RESISTANCE TO THE INTERACTION OF VARIOUS CATEGORIES OF REAGENTS OF PLASTICS	24
15. ANNEXES.	25
A. ADDITIONAL ACCESSORIES	
B. DECLARATION OF CONFORMITY CE	
C. DECLARATION OF CONFORMITY ROHS 2	
D. DECLARATION OF DECONTAMINATION (repair / return)	
E. NOMOGRAM RPM / RCF	

1. Application.

The MPW-55 centrifuge is a laboratory microcentrifuge for *in vitro* diagnostic (IVD), used to separation of samples took from people's, animal's and plant's components with different densities, to provide information about their biological state under the influence of the centrifugal force. Its construction ensures easy operation, safe work and wide range of applications at laboratories engaged in routine medical analyses, biochemical research works etc. This centrifuge is not biotight and therefore during centrifugation of preparations requiring biotightness one has to use closed and sealed rotors. In the centrifuge, it is prohibited to centrifuge caustic, inflammable and explosive preparations.

2. Technical data.

manufacturer	"MPW MED. INSTRUMENTS" SPÓŁDZIELNIA PRACY 46 Boremlowska Street, 04-347 Warsaw – Poland				
type	MPW – 55				
cat. no (REF)	10055/12-56				
mains voltage (L1+N+PE)	230 V	100V	110V	120V	127V
	±10%	±5%			
frequency	50/60 Hz				
maximum power consumption	90W				
overcurrent protection	fuse WTA-T 3,15A 250V				
capacity (maks.)	48 ml				
rotational speed range – RPM	100÷ 14500, step 100				
maximum acceleration – RCF [x g]	15279				
acceleration	3 linear characteristics				
deceleration	3 linear characteristics				
programs	9				
time range	15 s÷99 min 45 s, with 15 s interval and ∞				
interference level	according to PN-EN 55011				
environmental conditions:	PN-EN 61010-1 (pkt.1.4.1)				
place setting	inside only				
ambient temperature	+2° ÷ +40°C				
relative humidity at ambient temperature	< 80%				
installation category	II	PN-EN 61010-1			
degree of pollution	2	PN-EN 61010-1			
protection zone	300 mm				
dimensions:					
height (H)	180 mm				
widht (W)	220 mm				
depth (D)	270 mm				
noise level	≤ 56 dBA				
weight	5kg				

*- There is a possibility of using power inverter 12DC/230AC (look: **p.3.2**)

3. Installation.

3.1. Basic accessories (being enclosed to every centrifuge).

name	pcs	catalogue number
Centrifuge MPW-55	1	10055/12-56
Complete clamp	1	17167
Spanner for the rotor	1	17099T
Spanner for emergency opening of the cover	1	17162
Power cord 230V / 120V	1	17866/17867
Fuses WTA-T 3,15 A 250 V (230V)	2	17859
Technical vaseline 20ml	1	17201
User manual	1	See page 1.

3.2. OTHER ACCESSORIES

Catalog no

Specification

16098	Capillary caps
16135	Hematocrite reader – flat (sell out)
16150	Hematocrite reader – round
16696	Power inverter 300W (12DC→ 230 AC) (e.g. possibility of supply from the cigarette lighter socket)

3.3. Exploitation materials.



For operating in centrifuge one should use only original company's buckets comprised in the specification of accessories as well as test-tubes for centrifuges of proper diameter, length and strength. Utilization of test-tubes of other makes shall be agreed upon with manufacturer of the centrifuge. For cleaning and disinfecting one should use agents generally applied in the health service, such as e.g. *Aerodesina-2000*, *Lysoformin 3000*, *Melseptol*, *Melsept SF*, *Sanepidex*, *Cutasept F*.

3.4. Unboxing.

Open the package. Remove the box containing the accessories. Take out centrifuge from the container. Keep the box and packing materials in case of service shipping

3.5. Location.



The centrifuge shall not be located near the radiators and shall not be subjected to direct sunlight. The table for the centrifuge shall be stable and shall have flat-levelled table top. It is necessary to ensure a safety zone of the minimum 30 cm round the centrifuge from every direction. Normal operating conditions ambient temperature is from 15° C to 35° C. Passed parameters of the centrifuge are referring to the above named temperatures. At the change of the place from cold to warm one, condensation of water will occur inside the centrifuge. It is important then that sufficient time be provided for drying the centrifuge prior to starting the centrifuge again (minimum 4 hours).

3.6. Connection to mains.



Supply voltage given on the rating plate has to be consistent with local supply voltage. MPW MED. INSTRUMENTS laboratory centrifuges are 1st safety class devices and they are provided with the three-core cable with the plug resistant to dynamic loadings. Mains socket shall be provided with the safety pin. It is recommended to install emergency cut-out that shall be located far from the centrifuge, near the exit or beyond the room.

Supply voltage 100 ÷ 230 V 50/60 Hz.



Before switching on, check whether the centrifuge is connected to power supply correctly. Check centrifuge before usage whether she is installed correctly.

3.7. Fuses.

The centrifuge has standard protection with the WTA-T 3,15 A 250 V fuse. Fuse is situated in the plug-in socket unit at back wall of the centrifuge.

4. Description of the centrifuge.

4.1. General description.

New generation of MPW MED. INSTRUMENTS laboratory centrifuges is provided with state-of-the-art microprocessor control systems, very durable and quiet asynchronous brushless motors and accessories consistent with requirements of the present-day user.

4.2. Service elements.

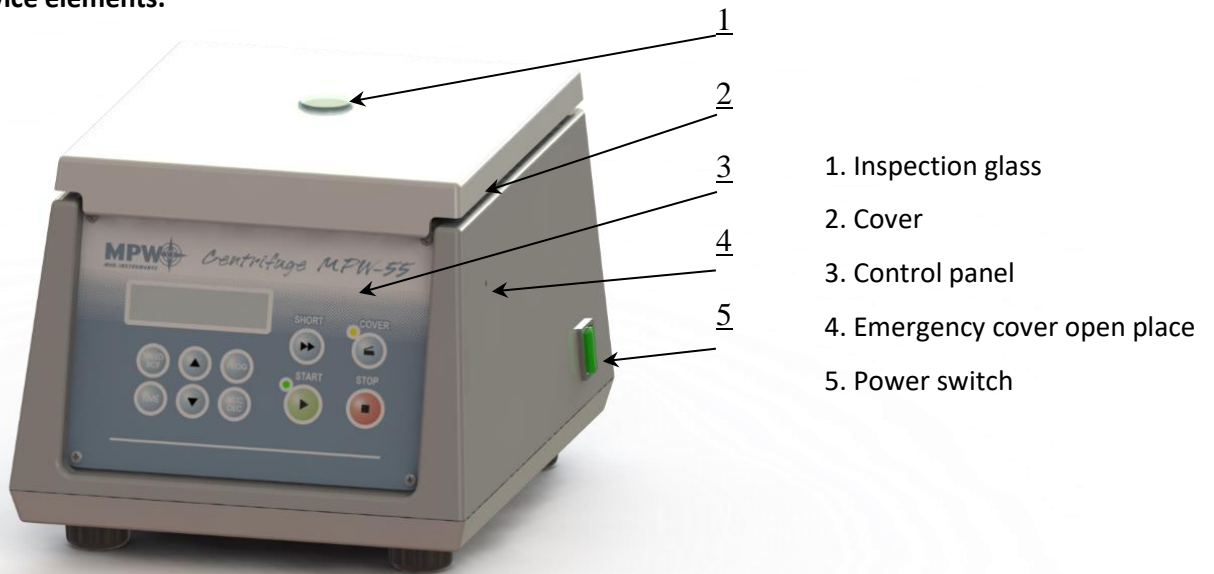

- 1. Inspection glass
- 2. Cover
- 3. Control panel
- 4. Emergency cover open place
- 5. Power switch

Drawing No.1. General view

- 1. Plug-in socket
- 2. Fuse base

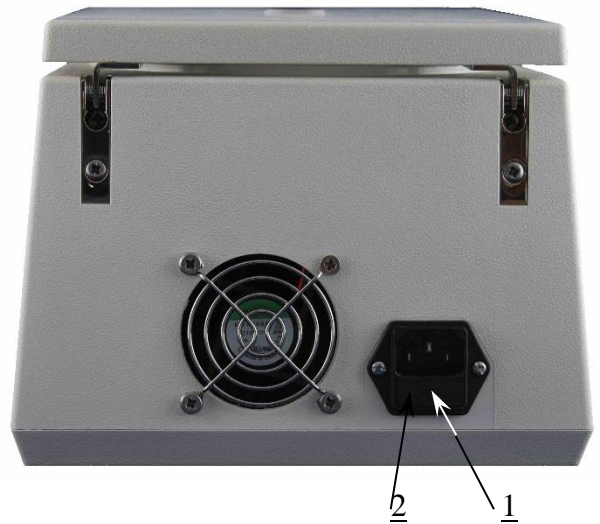

Drawing No.2.Back of centrifuge

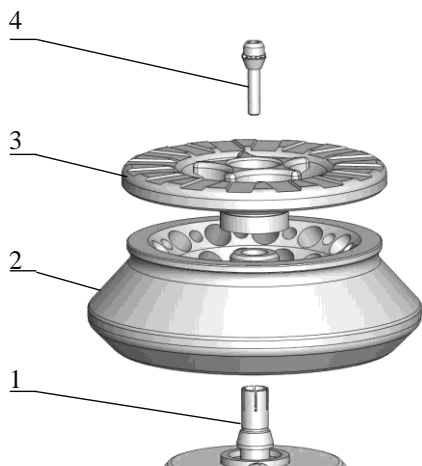

- 1. Motor axle
- 2. Rotor
- 3. Rotor lid
- 4. Complete clamp

Drawing No. 3. Unit elements of the angle rotor

5. Safe working conditions.

5.1. Servicing personnel.

	<ul style="list-style-type: none">▪ Laboratory centrifuge can be operated by laboratory personnel after getting acquainted with user manual.▪ This User Manual is part of the device.▪ User manual shall be always held near the centrifuge.▪ The centrifuge can not be misused.▪ If the centrifuge is used in a manner not specified by the manufacturer, the protection provided by the device may be impaired.
---	---





5.2. Guarantee and operational use period.

	<ul style="list-style-type: none">▪ Guarantee period amounts to 24 months (unless otherwise specified in the purchase documents).▪ Guarantee conditions are described in guarantee card..▪ The service life of the centrifuge specified by the manufacturer amounts to 10 years.▪ After 24 months from the start of the warranty period (date of purchase), a technical inspection of the centrifuge should be carried out (validation) by an authorized service of the manufacturer. Subsequent inspections should be carried out at annual intervals.▪ Maximum period of storage of not used centrifuge amounts to 1 year. After this period, a service authorized by manufacturer should carry out technical inspection of the centrifuge.▪ Manufacturer reserves the right to make technical changes in manufactured products.
---	---

5.3. Safekeeping period.

Maximum period of storage of not used centrifuge amounts to 1 year. After this period, a service authorized by manufacturer should carry out technical inspection of the centrifuge.

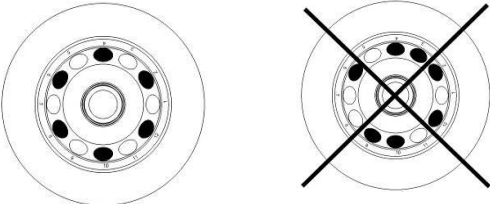
5.4. Hints on centrifuging.

	<ul style="list-style-type: none">• Set the centrifuge in horizontal position on rigid base.• Ensure safe positioning location.• Ensure free space around the centrifuge (amounting to at least 30 cm left free).• Ensure sufficient ventilation.• Fix the rotor on the motor axis firmly.
	<ul style="list-style-type: none">• Avoid unbalance.• Load the rotor holes with the same accessories.• Centrifugation of the test tubes of different sizes. There is a possibility to centrifuge test tubes of different sizes; however, it is absolutely necessary in such cases that opposite buckets and round carriers be the same.• It is necessary to insert test tubes symmetrically on the opposite sides. <div style="text-align: center;"></div> <ul style="list-style-type: none">• Fill test tubes outside the centrifuge.• Please pay special attention to the quality and proper thickness of the glass test tubes walls. Those shall be test tubes for centrifuges, of proper durability up to 5,000 x g.• In order to protect the centrifuge against unbalance, fill in the test tubes up to the same weight.
	<ul style="list-style-type: none">• Use only accessories in good condition.• Protect equipment against corrosion using accurate preventive maintenance.



- Infectious materials could be processed in closed rotors only.
-



- It is not allowed to centrifuge explosive and inflammable materials.
 - It is not allowed to centrifuge substances prone to reacting in result of supplying high energy during centrifugation.
-

5.5. Hazards and precautions



- Prior to switching the centrifuge on, one shall read carefully all sections of this instruction in order to ensure smooth operation and avoid damages of this device or its accessories.
-

- Centrifuge shall not be operated by unqualified laboratory personnel.
-



- Centrifuge must not be transported with the rotor mounted on the shaft.
-

- One must use original rotors, test-tubes and spare parts only.
-



- In the case of faulty operation of the centrifuge one shall ask of assistance of service of MPW MED. INSTRUMENTS or its authorized representatives.
-



- It is not allowed to switch the centrifuge on if it is not installed properly or rotor is not fitted correctly.
-



- The centrifuge must not be operated in places where explosion hazard appears as it is not explosion-proof make.
 - It is not allowed to subject to centrifugation materials, which subjected to action of air, could generate inflammable or explosive mixtures.
-



- It is prohibited to subject to centrifugation toxic or infectious materials with damaged leak proof seals of the rotor or test-tube. Proper disinfections procedures have to be carried out when dangerous substances contaminated the centrifuge or its accessories.
-



- It isn't allowed to open the cover manually in emergency procedure when rotor is still turning.
-



- It isn't allowed to exceed load limit set by the manufacturer. Rotors are intended for fluids of average homogeneous density equal to 1.2 g/cm³ or smaller when centrifugation is carried out at maximum speed. When fluids of higher density shall be used, then it is necessary to limit speed (see point 7.4.3 "Maximum load").
-



- It isn't allowed to use the rotors and round carriers with signs of corrosion or other mechanical defects.
 - It is not allowed to centrifuge highly corrosive substances which may cause material impairment and lower mechanical properties of rotor and round carriers.
 - It isn't allowed to use rotors and accessories not admitted by the manufacturer. Let to use commercial glass and plastic test tubes, which are destined to centrifuging in this laboratory centrifuge. One should absolutely not use poor quality elements. Cracking of glass vessels and test tubes could result in dangerous vibration of the centrifuge.
-



- It isn't allowed to carry out centrifugation with the rotor caps with taken off or not driven tight.
 - It isn't allowed to lift or shift the centrifuge during operation, and rest on it.
 - It isn't allowed to stay in the safety zone within 30 cm distance around the centrifuge neither leave within this zone some things, e.g. glass vessels.
 - It isn't allowed to put any objects on the centrifuge.
-

6. Operation of the centrifuge.

6.1. Mounting of the rotor and accessories.

1. Connect the centrifuge to the mains (master switch on back side of the centrifuge).
2. Open the cover of the centrifuge by pressing the **COVER** key. Prior to putting the rotor in, one has to check if rotational chamber is free of impurities, e.g. such as dust, glass splinters, residues of fluids that must be taken away.
3. One shall fit the rotor on the motor shaft driving it home on the cone.
4. Screw-in the bolt for fixing the rotor (clockwise) and screw it tightly home with the supplied spanner for the rotor.
5. Swing-out rotors have to be provided with the buckets in all seats. One should remember that every buckets swings individually. Bucket suspension studs should be lubricated periodically with technical petroleum jelly.
6. One should use only test tubes intended for selected types of the rotor - see p. 2.1. "Accessories".
7. Fill test tubes outside the centrifuge.
8. Put on or screw the caps on rotors.
9. Test tubes have to be filled properly in order to avoid overflows.
10.  **CAUTION: Centrifuge will tolerate small weight differences occurring during loading of rotors. However it is recommended to equalize vessels loads as much as possible in order to ensure minimal vibrations during operation. When the centrifuge is started with large imbalance, the unbalance control system will switch-off the drive system and error signal will be transmitted. On the monitoring panel, U sign will be displayed.**
11. In order to prolong lifetime of the rotor and gaskets, it is recommended to lubricate rotor's trunnions, used for hanging buckets, undercuts for trunnions in buckets, gaskets and threaded parts with the petroleum jelly.
12. For replacement of the rotor one shall unscrew clamping and then grab the rotor with both hands at opposite sides, taking it away from drive shaft by pulling it up.

6.2. Construction and safety measures.

The centrifuge has rigid self-supporting structure. Housing was made of ABS type plastic. Cover is fixed on steel axles of hinges and from the front is locked with electromagnetic lock blocking possible opening during centrifugation. Rotation chamber casing was made of thick steel sheet. The rotation chamber bowl is made of plastic. Rotors are from aluminum and reductive inserts from the polypropylene.

6.3. Drive.

Low noise induction motor constitutes the drive.

6.4. Data input and output.

Data setting and read-out system forms hermetically closed keyboard with distinctly accessible operation points. Easily readable displays signalling individual performed operations facilitate operator's programming and recording of parameters and condition of the centrifuge.

6.5. Controls.

The microprocessor control unit of the centrifuge ensures broad possibilities of providing, realisation and reading of work parameters, that is:

- selection of rotational speed within $100 \div 14500$ rpm at 100 rpm interval or RCF;
- setting centrifugation time within $15 \text{ s} \div 99 \text{ min } 45 \text{ s}$ range at 15 s interval or continuous operation;
- selection of **SHORT** – short duration operation;
- possibility to program 9 operation programs;
- selecting of 3 acceleration characteristics
- selecting of 3 deceleration characteristics

6.6. Safety devices.

Apart from the above described passive devices and safety measures there exist as well active devices and elements as follows:

6.6.1. Cover lock.

The centrifuge can be started only with properly closed cover. , the cover can be opened only after stopping the rotor. In the case of emergency opening of the cover during operation, the centrifuge will be immediately switched-off and the rotor will brake till complete stopping. With opened cover (the **COVER** diode is shining) the drive is completely disconnected from the power, which makes it impossible to start the centrifuge.

6.6.2. Unbalanced load checking system.

When loads of opposite buckets or carriers in rotors are unbalanced, the drive will be switched-off during acceleration or operation of the centrifuge – and the **U** sign will be displayed.

6.6.3. Rest state inspection.

Opening of the centrifuge's cover is possible only with the rotor in the state of rest. This state is being checked by the microprocessor which recognizes and signals with **S** sign on the display the rest state prior to opening the cover.

6.7. Increase a temperature

In uncooled centrifuges, the temperature in the rotor chamber, rotor and sample can increase to above 40°C, based on the run time, g-force (rcf)/speed and ambient temperature.

7. Description of the centrifuge operating elements.

Power switching ON/OFF is carried out with master switch situated on right side of the centrifuge. All settings on the centrifuge are done by means of the control panel. Panel comprises control keys and display.

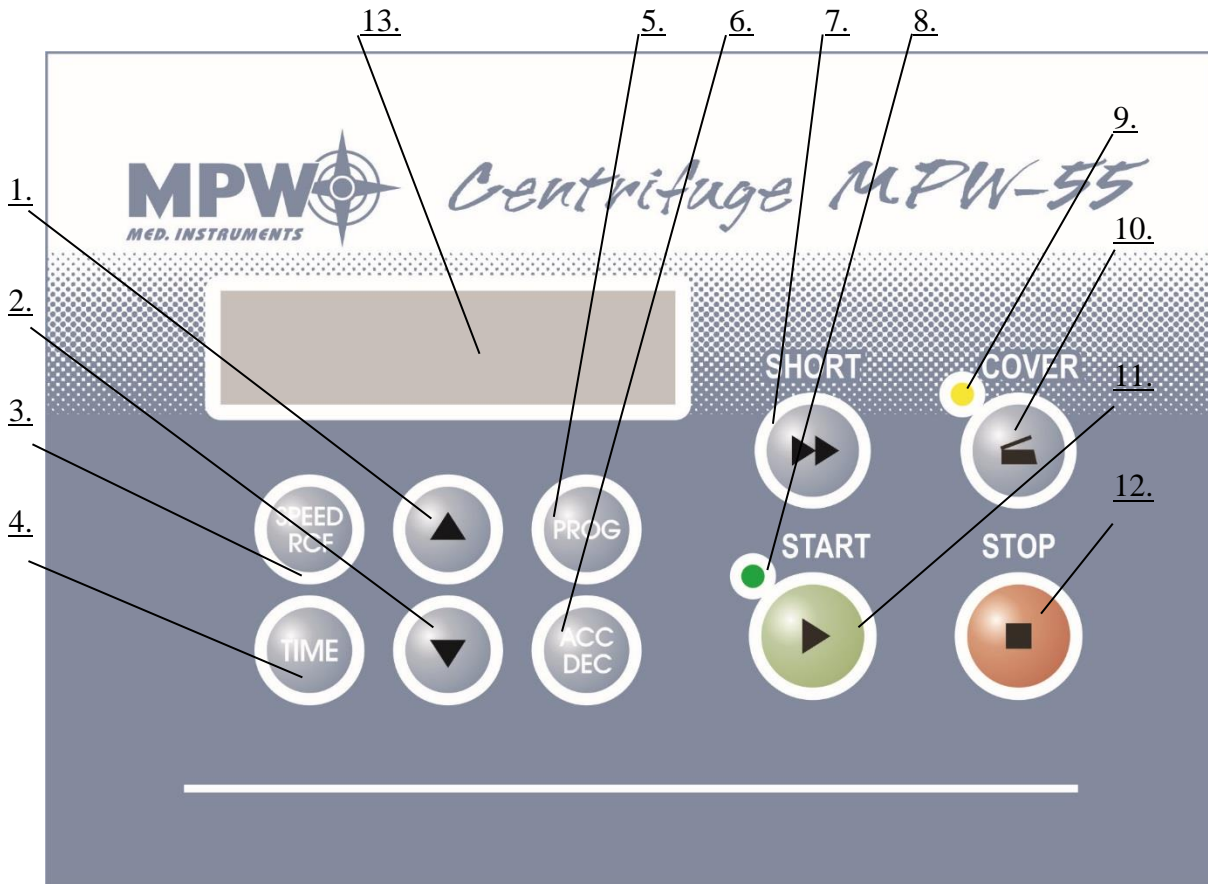

7.1. Control panel - Drawing No. 4.

For controlling centrifuge operation serves control panel placed on front casing wall.



Drawing No.4. Control panel

Control panel comprises following elements:

- ◆ **START** key  [element No.11] can be used to:
 - starting the centrifugation program with the parameters displayed on display,
 - blinking LED on the **START** key [element No. 8] signalling rotary motion of rotor.
 The centrifuge can be activated if:
 - the cover is closed (showing up of sign of the dot on the display [element No.13]),
 - the LED is not shining on the **COVER** key [element No.9]
- ◆ **STOP** key  [element No. 12] serves for aborting the actually running operation:
 - interrupting centrifugation program in any program phase and braking the rotor. After pressing the key will occur arrow ↓ on the display which indicated the rotor deceleration and the number of the deceleration mode,
 - finishing of braking rotor process – on the display will shine sign **S** (Stop) also signalling this state by sound.
- ◆ **COVER** key  [element No. 10] serves for:
 - open the centrifuge cover,

Open or incorrectly closing the cover is signalling by LED shining, key is active only if the rotor is not centrifuging,

The cover can be opened only if rotor is stopped, on the display will be displayed sign **S** and the centrifuge will signal possibility of opening cover by short five sounds.

ATTENTION: It is not possible to open of the centrifuge at moment when the sign = signalling of possibility to change the parameter value is active, even in spite of the stopped rotor.





- ◆ **SHORT** key [element No. 7] serves for:
 - short duration operation of the centrifuge in time of holding down the key till moment of key releasing,
 - the rotor of *Short* mode accelerates to speed value setting in the program,
 - accelerating and decelerating of rotor is in accordance with programmed characteristics,
 - pressing the **STOP** key after releasing **SHORT** key during the braking of rotor will cause quicker braking of rotor according to characteristic No.1,
 - the centrifugation time in *Short* mode is measured in minutes and seconds from the start of the centrifuging (pressing the **SHORT** key) to the rotor stop.

- ◆ The field of functional keys serves for change the program as well for setting it's individual parameters such as: speed, RCF, time, acceleration and deceleration mode.
 - After pressing the key, the sign equal "=" appears on the display. It means that the value of given parameter can be changed by key: arrow down or arrow up.
 - The possibility of changing the value of parameter is signalling by sign = and is active for a three seconds. It is time, when one should accede to set the demanded value. After three seconds from the setting of the demanded value of given parameter, this value will be saved in the program or after selection the given program will be set as active.

- ◆ Decreasing key, arrow down  [element No. 2] serves for:
 - decreasing the values of parameters.

- ◆ Increasing key, arrow up  [element No. 1] serves for:
 - increasing the values of parameters.

- ◆  key [element No. 3] serves for:
 - selecting the possibility of changing the centrifuging speed – **SPEED**
 - next pressing of the key switching-over the programming mode from speed to **RCF** values.

- ◆  key [element No. 4] serves for:
 - programming the centrifuging time in minutes from 15 s to 99 min 45 s. Setting the sign --m--s over the 99 m 45 s, it will cause the continuous operation of the centrifuge.

- ◆  key [element No. 6] serves for:
 - programming the rotor acceleration **ACC** and deceleration **DEC** characteristics.
 - The rotor acceleration characteristic is represented with an arrow up ↑. Pressing this key again will result in switching from rotor acceleration programming mode to rotor deceleration programming mode. The rotor deceleration characteristic is represented with an arrow down ↓. The user can select three deceleration and acceleration characteristics. Characteristics with number 1 are the fastest.

- ◆  key [element No. 5] serves for:
 - selecting program number which will be realized or reprogrammed,
 - It is possible to save the nine programs,

- ◆ Sound signal
 - sound signal is an appendix of the information given by optical path.

- one short signal – confirmation of the made command (e.g. increasing parameter and such)
- two short signals – signalling the impossibility of the made command (e.g. increasing the centrifuging speed above 14500)
- one long signal – signalling the start of the following processes:
 - breaking after pressing the **STOP** key,
 - beginning the centrifuging operation in *Short* mode and breaking after releasing the **SHORT** key,
- five short sounds – stopping the rotor and **possibility to open the cover**,
- five short sounds and one long signal – signalling readiness after switching the supply on.

◆ LCD display

The centrifuge has readable display LCD, on which are showing information being referred to the actual condition of the system.

The information about the centrifuge type, program version and internet address are displaying at once after switching supply on for three seconds.

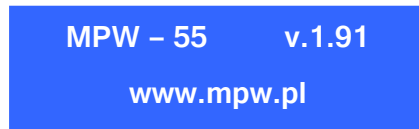

— following the information about program has been lately made, the time, speed and acceleration characteristic settings will be displayed.

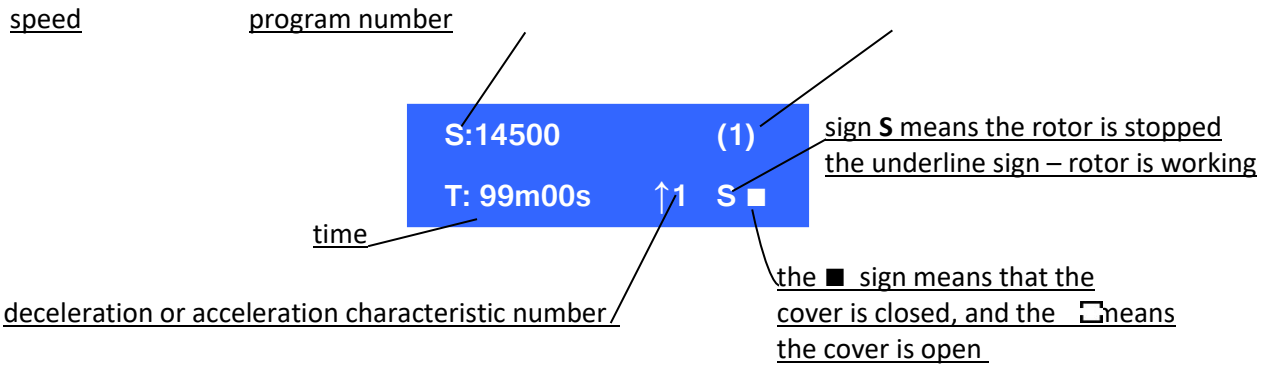

after pressing the  key twice [element No. 3 on Drawing 4.] the display shows the acceleration value corresponding to the programmed speed

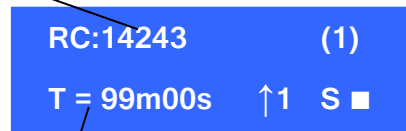

The "=" sign means that the given parameter can be modified

During operation of the centrifuge one cannot change the program parameters, but only interrupt its further realization with pressing the **STOP** key, [element No.12].

7.2. Switching the centrifuge on.

After acquainting with operation elements, programming and preparing the centrifuge to operation one shall set the program, next close the cover and press the **START** key. The centrifuge will start and realize the programmed program.

7.3. Switching the centrifuge off.

The centrifuge is automatically switching off when the program will be realized. It is possible to finish earlier the realization of given program by pressing the **STOP** key. After ending the centrifugation process one should remember to switch off the centrifuge using the main switch being located from the side of centrifuge.

7.4. Mathematical relations.

7.4.1. RCF – relative centripetal force.

RCF acceleration is the acceleration generated by the rotary motion of the rotor acting upon tested product and it can be calculated according to the formula:

$$\text{RCF} = 11,18 \times r \times (n/1000)^2$$

$$\text{RCF} \quad [x \text{ g}], \quad r \text{ [cm]}, \quad n \text{ [rpm]}$$

Depending on the distance of particles of the tested product from the axis of rotation, one can establish with use of the above formula the minimum RCF, average RCF or maximum RCF. On the basis of pre-set RCF value and given radius of the bottom of the bucket one can calculate with it the rotational speed to be set in the program of centrifuging. Selection of the time of sedimentation and the RCF value shall be carried out experimentally for any given product.

Once every 100 rpm, an electronic circuit automatically calculates and displays RCF value. In order to program required RCF value one shall use nomogram (Drawing No. 5) or change the rotational speed, matching displayed value to required acceleration value.

7.4.2. Nomogram of relationship - rotational speed/centrifuging radius/RCF – Attachment

7.4.3. Maximum load.

In order to avoid overloading of the rotor one shall observe maximum load which is recorded on every rotor. Maximum permissible load is reached when all test-tubes are filled with the fluid with 1.2 g/cm³ density. If density of the centrifuged liquid is higher than 1.2 g/cm³, then test-tubes could be filled only partially or one shall limit operation speed of the centrifuge, which is being calculated from the formula:

$$n_{\text{perm}} = n_{\text{max}} * \sqrt{\frac{1,2}{\gamma}}; \quad \gamma = \text{specific gravity} \left[\frac{G}{\text{cm}^3} \right]; \quad n_{\text{max}} \text{ [maximum rotational speed - rpm]}$$

8. Cleaning, disinfection, maintenance.

CAUTION! It is necessary to use protective gloves during following work.

8.1. Cleaning of the centrifuge.

For cleaning, water with soap or other water soluble mild detergent shall be used. One should avoid corrosive and aggressive substances. It is prohibited to use alkaline solutions, inflammable solvents or agents containing abrasive particles. Using wiping cloth, remove condensate or residues of the products from the rotor chamber. It is recommended to keep the cover opened when the centrifuge does not work in order to expel the moisture.



In the case the user decides to use centrifuge and equipment cleaning methods other than the ones described in this manual, the user shall contact the device manufacturer in order to check whether the cleaning method chosen does not damage the device.

8.2. Cleaning of the accessories.

In order to ensure safe operation one shall carry out in regular way periodical maintenance of the accessories. Manufactured rotors and round carriers have to withstand steady high stresses originating from the centrifugal force. Chemical reactions as well as corrosion (combination of variable pressure and chemical reactions) can cause corrosion or destruction of metals. Hard to observe surface cracks increase gradually and weaken material without visible symptoms. In the case of observation of surface damage, crevice or other change, as well as the corrosion, the given part (rotor, carrier etc.) shall be immediately replaced. In order to prevent corrosion one has to clean regularly the rotor with the fastening bolt and round carriers. Cleaning of the accessories shall be carried out outside of the centrifuge once every week or still better after each use. Then, those parts shall be dried using soft fabric or in the chamber drier at ca. 50° C.

Especially prone to the corrosion are parts made of aluminium. For cleaning them one should use neutral agent of pH value from 6 to 8. It is forbidden to use alkaline agent of pH above 8. In this way, the useful service life of the device is substantially increased and susceptibility to corrosion is diminished. Accurate maintenance increases the service life as well and protects against premature rotor failures. Corrosion and damages resulting from insufficient maintenance could not be subject of claims lodged against the manufacturer.

8.3. Sterilization and disinfections of the rotational chamber and accessories.

One can use all standard disinfectants. The centrifuges and accessories are constructed from various materials and one should to take into account possible variety of materials (see p. 6.2). During sterilization by means of steam one should to consider temperature resistance of individual materials.

STERILIZATION

	Sterilization* temp. 121 °C, time 20 min	Radiation – β/γ 25 kGy	Gas (ethylene oxide)	Chemical compounds (formalin, ethanol)
PS	no	yes	no	yes
SAN	no	no	yes	yes
PMMA	no	yes	no	yes
PC	yes ¹⁾	yes	yes	yes
PVC	no ²⁾	no	yes	yes
POM	yes ¹⁾	yes	yes	yes
PE-LD	no	yes	yes	yes
PE-HD	no	yes	yes	yes
PP	yes	yes	yes	yes
PMP	yes	yes	yes	yes
ECTFE/ETFE	yes	no	yes	yes
PTFE	yes	no	yes	yes
FEP/PFA	yes	no	yes	yes
FKM	yes	-	yes	yes

EPDM	yes	-	yes	yes
NR	no	no	yes	yes
SI	yes	no	yes	yes
<p>* Laboratory vessels have to be exactly cleaned and rinsed with the distilled water before the sterilization in the autoclave. It is always necessary to remove closures from containers!</p> <p>1) The frequent steam sterilization reduces mechanical durability! PC test tubes may become useless.</p> <p>2) Except PVC hoses which are resistant to the steam sterilization in the temperature 121 °C.</p>				

Abbreviations of names of characterized plastics

PS:	Polystyrene	ECTFE:	Ethylene/chlorotrifluoroethylene
SAN:	Styrene-acrylonitrile	ETFE:	Ethylene/tetrafluoroethylene
PMMA:	Polymethyl methacrylate	PTFE:	Polytetrafluoroethylene
PC:	Polycarbon	FEP:	Tetrafluoroethylene/perfluoropropylene
PVC:	Polyvinyl chloride	PFA	Tetrafluoroethylene/perfluoroalkylvinylether
POM:	Acetal polyoxymethylenel	FKM	Fluorcarbon rubber
PE-LD:	Low density polyethylene	EPDM:	Ethylene propylene diene
PE-HD:	High density polyethylene	NR:	Natural rubber
PP:	Polypropylene	SI:	Silicon rubber
PMP:	Polymethylpentene		



For centrifuging infectious materials it is necessary to use hermetically closed buckets, in order to prevent they migration into the centrifuge.

Rotors, buckets and round carriers can be sterilized in autoclave with temperature 121° – 124° C and pressure 215 kPa during 20 min. In the centrifuge, disinfectants and cleaning agents generally used in medical care should be used (e.g. *Aerodesina-2000, Lysoformin 3000, Melseptol, Melsept SF, Sanepidex, Cutasept F*).



User is responsible for proper disinfections of the centrifuge, if some dangerous material was spilled inside or outside of the centrifuge.
During the above mentioned works one must wear safety gloves.

9. Emergency conditions – service.

9.1. Fault finding.

Majority of faults could be removed by switching the centrifuge **OFF** and then **ON**. After switching the centrifuge **ON**, there shall be displayed parameters of the recently implemented program and sound signals comprising four successive tones shall be generated. In the case of short-duration power failure the rotor is decelerate.

Please find below the most frequent faults and their repair methods.

1. Lack of the display:	Remedies:
<i>Is mains socket live ?</i>	<i>Check mains socket fuse.</i>
<i>Is supply cable plugged into socket ?</i>	<i>Plug correctly supply cable.</i>
<i>Is input fuse good ?</i>	<i>Replace input fuse (rated data on rating plate).</i>
<i>Is master switch switched ON ?</i>	<i>Switch ON power supply.</i>
<i>Above was checked and still there is not display active.</i>	<i>Call service.</i>
2. Centrifuge does not start:	Remedies:
<i>START key pushing does not generate reaction or single tone only</i>	
<i>P message is displayed</i>	<i>Call service</i>
<i>LED diode of cover is shining</i>	<i>Close cover. The lock has to be locked with typical sound. He has to the sign of the dot appear on the display. If the diode is not switching off one shall call service.</i>
<i>LED diode of "Start" key is shining</i>	<i>Switch power supply OFF/ON. If fault still persists then call service.</i>
<i>The digit of display parameters is blinking</i>	<i>Push the "Stop" key which has being recorded program. If fault still persists then call service.</i>
3. Centrifuge starts but does not accelerate	Remedies:
<i>E symbol displayed after stopping. Drive overload</i>	<i>Wait for 15 minutes and switch again after opening and closing the cover.</i>
4. One cannot open the cover:	Remedies:
<i>With the attempt opening cover is audible buzzing of the lock.</i>	<i>One should lift up till the yellow LED "Cover" is switching on. Failed spring of cover lifting or bended the lock striker. One should bend the striker or call service.</i>
<i>LED diode "Cover" is not shining and the centrifuge not swirling.</i>	<i>Lock is failed. Call service.</i>

Emergency cover release	
	<p>You can manually open the lid (e.g. in case of power failure). To do this, insert the key into the emergency opening of the cover (Cat. No. 17162) into the hole on the right side of the chassis and then push it until you release the lock of the lock and open the cover.</p> <p>CAUTION! The cover can be open the emergency only when the rotor is at rest. You should check this by see inside the centrifuge using the viewfinder provided in the lid.</p>

9.2. Work safety inspection.

For safety reasons, inspections of the centrifuge carried out by the authorized service at least once a year after the period of warranty. The reason for more frequent inspections could be corrosion inducing environment. Examinations should end with issuing "Report of validation, the check on the technical state of the laboratory centrifuge". It is being recommended to establish "Technical passport" or "Log of the apparatus", in whom every repairs and reviews are being registered. Both these documents should be stored in the place of use of the centrifuge.

9.3. Inspection procedures carried out by the operator.

Operator has to pay special attention to the fact that the centrifuge parts of key importance due to safety reasons are not damaged.

This remark is specifically important as for:

1. Motor suspension
2. Motor axis concentricity
3. Centrifuge accessories and especially structural changes, corrosion, preliminary cracks, abrasion of metal parts.
4. Screw joints.
5. Inspection of the rotor assembly.
6. Inspection of bioseals of the buckets if such are used.
7. Control of execution of the guarantee yearly technical inspection of the centrifuge

Only the manufacturer-specified holders, included in the equipment list, as well as centrifuge capillaries, which diameter, length and durability are suitable, should be used for spinning in this centrifuge. The use of equipment made by other manufacturers should be consulted with the manufacturer of the centrifuge. Disinfectants and cleaning agents generally used in medical care should be used in this centrifuge (e.g. *Aerodesina-2000*, *Lysoformin 3000*, *Melseptol*, *Melsept SF*, *Sanepidex*, *Cutasept F*).

10. Repair conditions.

Manufacturer grants to the Buyer the guarantee on conditions specified in the Guarantee Certificate. Buyer forfeits the right to guarantee repair when using the device inconsistently with the Operating Instruction provisions, when damage results from the User's fault. Repairs should be carried out in authorized service workshops, granted with the MPW Certificate. The centrifuge shall be sent to repair after decontaminating disinfections. Information about authorized service workshops could be obtained from the Manufacturer.

11. Transport and storage



CAUTION! Due to the heavy weight of the device, lifting and carrying it may cause injury to the spine.

- Store the device only in a closed and dry room.
- Remove rotor from centrifuge before transport.
- Lift and carry with the adequate number of people.
- Use transport equipment.
- Use the original packaging and transport protection for transport.

Transport and storage conditions.

	Storage (in the package)	Storage (without the package)	Transport
Temperature	-25 ÷ +55 °C	-5 ÷ +45 °C	-25 ÷ +60 °C (general) -20 ÷ +55 °C (air)
Relative humidity	10 ÷ 75 %	10 ÷ 75 %	10 ÷ 75 %
Pressure	70 ÷ 106 kPa	70 ÷ 106 kPa	30 ÷ 106 kPa

12. Disposal.



- The device disposed of in accordance with applicable regulations.
- Pursuant to guideline 2002/96/EC (WEEE), all devices supplied after August 13, 2005, may not be disposed as part of domestic waste.
- The device belongs to 8th group (medical devices) and is categorized in business to business field.
- The icon of the crossed-out trash can shows that the device may not be disposed as part of domestic waste.
- The waste disposal guidelines of the individual EC countries might vary. If necessary, contact your supplier.

13. Manufacturer's data.

"MPW MED. INSTRUMENTS" SPÓŁDZIELNIA PRACY

Boremlowska 46 Street

04-347 Warsaw

tel. (+48) 22 610 56 67 (sales department - POLAND)
(+48) 22 879 70 46 (sales department - outside POLAND)
(+48) 22 610 81 07 (service)

fax: (+48) 22 610 55 36

e-mail: mpw@mpw.pl

website: www.mpw.pl

000042924 - number of entry in the Waste Database

PL/CA01-01782 - identification number given by Office for Registration of Medicinal Products, Medical Devices and Biocidal Products.

Distributor's info

DISTRIBUTOR:

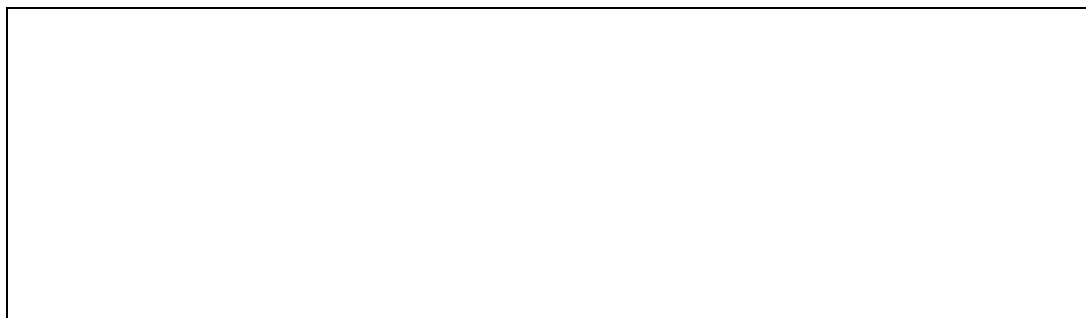

14. Table of chemical resistance to the interaction of various categories of reagents of plastics

Groups of the substance in temp. 20°C	PS	SAN	PMMA	PC	PCV	POM	PE-LD	PE-HD	PP	PMP	ECTFE ETFE	PTFE FEP PFA	FKM	EPDM	NR	SI
Aldehydes	-	-	o	o	-	o	-	+	+	o	+	+	+	+	o	o
Cyclic alcohols	+	+	+	+	+	+	+	+	+	+	+	+	-	+	+	+
Esters	-	-	-	-	-	-	+	o	o	o	+	+	-	o	o	o
Ether	-	-	-	-	-	+	+	o	o	-	+	+	-	-	-	-
Ketones	-	-	-	-	-	+	o	o	o	o	o	+	-	o	-	-
Strong or concentrated acids	o	-	-	-	+	-	+	+	+	+	+	+		+	-	-
Weak or diluted acids	o	o	o	o	+	-	+	+	+	+	+	+	+	+	o	o
Oxidizing acids or oxidizing substances	-	-	-	-	-	-	-	-	-	-	+	+	o	o	-	-
cyclic hydrocarbons	-	-	o	o	+	+	+	+	+	o	+	+	o	-	-	-
Ahs	-	-	-	-	-	+	+	o	o	-	+	+	o	-	-	-
Haloid hydrocarbons	-	-	-	-	-	+	+	o	o	-	+	+	o	-	-	-
Alkalis	+	+	-	-	+	+	+	+	+	+	+	+	o	+	+	o

+ = very good chemical resistance

Permanent action of the substance isn't causing damage through 30 days. The material is able to be resistant through years.

o = chemical resistance of good to limited

Continuous action of the substance is causing insignificant damage through the period of 7-30 days, partly reversible (e.g. puffing up, softening, reduced mechanical durability, discolouring).

- = limited chemical resistance

The material isn't able to have the continuous contact with the substance. The immediate occurrence of damage is possible (e.g. the loss of mechanical durability, the deformation, discolouring, bursting, dissolving).

Abbreviations of names of characterized plastics

PS:	Polystyrene	ECTFE:	Ethylene/chlorotrifluoroethylene
SAN:	Styrene-acrylonitrile	ETFE:	Ethylene/tetrafluoroethylene
PMMA:	Polymethyl methacrylate	PTFE:	Polytetrafluoroethylene
PC:	Polycarbon	FEP:	Tetrafluoroethylene/perfluoropropylene
PVC:	Polyvinyl chloride	PFA:	Tetrafluoroethylene/perfluoroalkylvinylether
POM:	Acetal polyoxymethylenel	FKM:	Fluorcarbon rubber
PE-LD:	Low density polyethylene	EPDM:	Ethylene propylene diene
PE-HD:	High density polyethylene	NR:	Natural rubber
PP:	Polypropylene	SI:	Silicon rubber
PMP:	Polymethylpentene		

15. Annexes.

A. Wyposażenie dodatkowe/Optional accessories**MPW-55****WIRNIK / ROTOR****PARAMETRY WIRNIKA / ROTOR PARAMETERS****POJEMNIK/BUCKET****WKŁADKA / ADAPTER**

[liczba probówek na wirnik/tubes per rotor] PROBÓWKA / TUBE

11201**RPM 14500, RCF 13163, Rmax 56, ϕ 45****bez pojemnika/without bucket****bez wkładki/without adapter**

[2]	15122	8 x 0,2 ml probówki szeregowe PCR-strip (10,2 x 72,4 mm) 8 x 0,2 ml PCR strip (10,2 x 72,4 mm)
[24]	15125	0,2 ml probówka PCR (6 x 21,6 mm) 0,2 ml PCR tube (6 x 21,6 mm)
[2]	15130	8 x 0,2 ml probówki szeregowe PCR strip (7,3 x 77,2 mm) 8 x 0,2 ml PCR strip (7,3 x 77,2 mm)
[4]	15131	4 x 0,2 ml probówki szeregowe PCR-strip (10,2 x 37,2 mm) 4 x 0,2 ml PCR strip (10,2 x 37,2 mm)

11202**RPM 14500, RCF 15279, Rmax 65, ϕ 42****bez pojemnika/without bucket****14084**

[12]	15127	0,5 ml probówka PCR (7,8 x 31 mm) 0,5 ml PCR tube (7,8 x 31 mm)
------	-------	--

14133

[12]	15125	0,2 ml probówka PCR (6 x 21,6 mm) 0,2 ml PCR tube (6 x 21,6 mm)
------	-------	--

bez wkładki/without adapter

[12]	*	2-1,5 ml probówka (10,8x41,8 mm), Eppendorf®; [15011], 2 ml (10,8x41,8 mm); [15128], 1,5ml (10,8x40,5 mm) 2-1,5 ml tube (10,8x41,8 mm), Eppendorf®; [15011], 2 ml (10,8x41,8 mm); [15128], 1,5ml (10,8x40,5 mm)
------	---	--

11204**RPM 14500, RCF 15279, Rmax 65, ϕ 51, 32****bez pojemnika/without bucket****14084**

[24]	15127	0,5 ml probówka PCR (7,8 x 31 mm) 0,5 ml PCR tube (7,8 x 31 mm)
------	-------	--

14133

[24]	15125	0,2 ml probówka PCR (6 x 21,6 mm) 0,2 ml PCR tube (6 x 21,6 mm)
------	-------	--

bez wkładki/without adapter

[24]	*	2-1,5 ml probówka (10,8x41,8 mm), Eppendorf®; [15011], 2 ml (10,8x41,8 mm); [15128], 1,5ml (10,8x40,5 mm) 2-1,5 ml tube (10,8x41,8 mm), Eppendorf®; [15011], 2 ml (10,8x41,8 mm); [15128], 1,5ml (10,8x40,5 mm)
------	---	--

A. Wyposażenie dodatkowe/Optional accessories**12205****RPM 14500, RCF 14574, Rmax 62, ϕ 90****bez pojemnika/without bucket****bez wkładki/without adapter**

[24] 15101	19 μ l kapilara hematokrytowa (1,3 x 50 mm)
	19 μ l micro-hematocrit capillary tube (1,3 x 50 mm)

DECLARATION OF CONFORMITY

Product name: **Laboratory centrifuge MPW-55**

Product type: **Laboratory centrifuge**

This declaration of conformity is issued under the sole responsibility of the manufacturer.

Product classification on the basis of the Directive 98/79/EC: Non classified to list A or B and not for self-testing.

Product complies with the requirements:

• **Directive 98/79/EC (IVD), including the requirements of harmonized standards:**

EN 15223-1:2016	EN ISO 18113-3:2011
EN 13612:2002	EN 61326-2-6:2006
EN 13612:2002/AC:2002	EN 61010-2-101:2002
EN 13975:2003	EN 62304:2006
EN ISO 14971:2012	EN 62304:2006/AC:2008
EN ISO 18113-1:2011	EN 62366:2008

• **selected harmonized standards of Directive 2014/35/UE (LVD):**

EN 61010-1:2010	EN 61010-2-020:2006
-----------------	---------------------

• **directive 2014/30/UE (EMC).**

„MPW MED. INSTRUMENTS”
SPÓŁDZIELNIA PRACY
w Warszawie

„MPW MED. INSTRUMENTS”
SPÓŁDZIELNIA PRACY

Warsaw, 46 Boremlowska Street
applies Quality Management System in line with
PN-EN ISO 9001:2015, PN-EN ISO 13485:2016

Certifying authority:

Członek Zarządu
Wojciech Anisiewicz

PREZES ZARZĄDU
mgr Łukasz Satański





DECLARATION OF CONFORMITY

(with RoHS 2 Directive 2011/65/EU)

DEKLARACJA ZGODNOŚCI

(z dyrektywą RoHS 2 2011/65/UE)

PRODUCT DETAILS/DANE PRODUKTU

Product name/Nazwa produktu:

Laboratory centrifuge MPW-55 /

Wirówka laboratoryjna MPW-55

Product type/Typ:

Laboratory centrifuge/Wirówka laboratoryjna

Manufactured by/Wytworzona przez:

„MPW MED. INSTRUMENTS”

SPÓŁDZIELNIA PRACY

ul. Boremlowska 46, 03-347 Warszawa, Polska

We hereby declare under our sole responsibility, that the product above is in compliance with the requirements of RoHS 2 Directive 2011/65/EU. /

Niniejszym deklarujemy z pełną odpowiedzialnością, że produkt, do którego odnosi się niniejsza deklaracja, jest zgodny z Dyrektywą RoHS 2 2011/65/UE.

„MPW MED. INSTRUMENTS”
SPÓŁDZIELNIA PRACY
w Warszawie

Warsaw/Warszawa, 2018.09.15

(place and date of issue/miejsce i data
sporządzenia deklaracji)

Wojciech Anisiewicz

Member of Management
Board/Członek Zarządu

(name and signature of authorized person/imię i nazwisko osoby
upoważnionej do sporządzenia deklaracji)

Łukasz Sałański

President of Management
Board/Prezes Zarządu

DECLARATION OF DECONTAMINATION

(repair)

In order to protect our employees please fill out the declaration of decontamination completely before sending centrifuge to the manufacturer (repair).

1. Device:

– type:

– serial No.:

2. Description of decontamination

(see user manual)

.....

.....

.....

.....

3. Decontamination carried out by:

name:

4. Date and signature:

.....

DECLARATION OF DECONTAMINATION

(return)

In order to protect our employees please fill out the declaration of decontamination completely before sending centrifuge to the manufacturer (return).

1. Device:

– type:

– serial No.:

2. Description of decontamination

(see user manual)

.....
.....
.....
.....

3. Decontamination carried out by:

name:

4. Date and signature:

.....

NOMOGRAM

Centrifuging radius [cm]

R.C.F. (x "g")
multiple of
gravitational
acceleration

[r.p.m.]

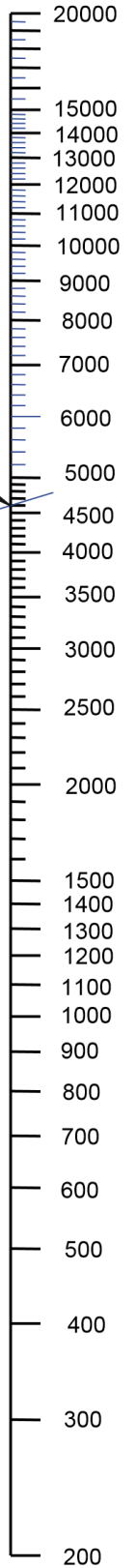
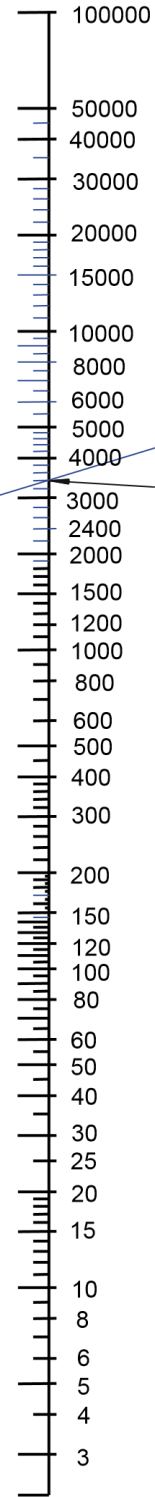
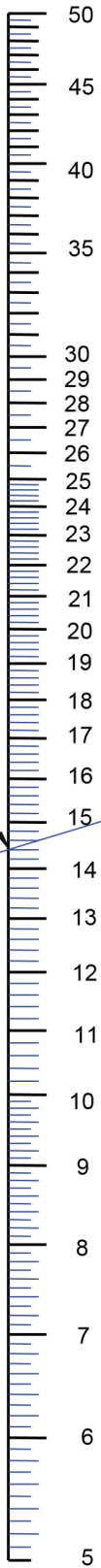

Formula used for calculation of this nomogram :

$$R.C.F. = 11,18 * r * (n/1000)^2$$

where :

- R.C.F. - multiple of gravitational acceleration
- r - centrifuging radius (cm)
- n - rotational speed (r.p.m.)
- g - gravitational acceleration

Example of making use
of the nomogram:

A=14,4 cm
B=4600 r.p.m.
C=3400 x g

$$n = 1000 * \sqrt{\frac{RCF}{(11,18 * r)}}$$

$$r = \frac{RCF}{\left[11,18 * \left(\frac{n}{1000} \right)^2 \right]}$$

A

B

C