

# USER MANUAL



## MPW-380 MPW-380R

**Read before use!**

Serial number of centrifuges: .....

For centrifuges with serial no (SN):

**MPW-380**      10380037224 – ...

**MPW-380R**    10380R037823 – ...



This manual was prepared with particular care. MPW MED. INSTRUMENTS may change the manual at any time and without notice because of improvements, typographical errors, or improvements to facilities  
All rights reserved. No part of this User Manual may be modified, distributed, published, or reproduced without the prior permission of MPW MED. INSTRUMENTS.

You can find the current version of the user manual on our website under:

**www.mpw.pl** **DOWNLOAD** section (one should choose demanded language version of website).











# Content

<b>1. Symbols used in the manual and on the device</b> .....	<b>5</b>
1.1 Markings on the device .....	5
<b>2. Application</b> .....	<b>6</b>
<b>3. Technical specification</b> .....	<b>7</b>
3.1 Environmental conditions .....	7
<b>4. Installation</b> .....	<b>8</b>
4.1 Content of the package .....	8
4.2 Location selection.....	8
4.3 Preparation for installation .....	8
4.4 Centrifuge installation .....	9
4.5 Starting the centrifuge .....	9
4.6 Opening and closing the cover .....	9
4.7 Current protection.....	10
<b>5. Safety notes</b> .....	<b>10</b>
5.1 General remarks .....	10
5.2 Placing the rotor and accessories in the centrifuge .....	10
5.3 Filling tubes .....	11
5.4 Filling the rotor .....	11
5.4.1 <i>Angular rotors</i> .....	11
5.4.2 <i>Horizontal rotors</i> .....	12
5.5 Safety hints.....	13
5.6 Operating conditions .....	14
5.7 Equipment life .....	14
5.8 Work safety .....	15
5.9 Unbalance.....	15
5.10 Emergency stop .....	16
5.11 Residual risk.....	16
5.12 Obligation to report a serious device incident .....	16
<b>6. Product description</b> .....	<b>17</b>
6.1 Product Design and Appearance .....	17
6.2 Name plate .....	18
6.3 Control device .....	18
6.4 Setting parameters .....	18
6.5 Safety features .....	18
6.6 Increase in temperature (MPW-380 only).....	19
<b>7. Centrifuging</b> .....	<b>20</b>
7.1 Control panel.....	20
7.2 Display .....	20
7.3 Setting up RPM, RCF, time, temperature .....	22
7.4 Users programs .....	23
7.5 Creator of acceleration and deceleration curves .....	25
7.5.1 <i>Acceleration characteristic, Creation of episode 1</i> .....	25
7.5.2 <i>Adding and editing sections - acceleration</i> .....	26
7.5.3 <i>Acceleration graph</i> .....	27
7.5.4 <i>Deceleration characteristic – creating section 1</i> .....	27
7.5.5 <i>Adding and editing sections - deceleration</i> .....	28
7.5.6 <i>Deceleration graph</i> .....	28
7.5.7 <i>Deleting sections</i> .....	28
7.6 Programs with user characteristics .....	29
7.7 Rotor choosing .....	29
7.8 SHORT mode.....	29
7.9 Finishing the centrifuging .....	29
7.10 Temporarily disabled functions.....	30
<b>8. Temperature control</b> .....	<b>30</b>
8.1 Initial cooling during centrifuging –FAST COOL.....	31

8.2	Initial cooling or heating without centrifuging – THERMAL CHAMBER .....	31
8.3	Cooling or heating in “START DELAY – OF TEMPERATURE” mode .....	31
8.4	Cooling or heating in „SHORT” mode .....	31
8.5	Cooling and heating notes .....	32
<b>9.</b>	<b>Parameters of centrifugation .....</b>	<b>32</b>
9.1	Acceleration/deceleration – changing characteristic .....	32
9.2	Radius .....	33
9.3	Sample density .....	33
9.4	Temperature offset .....	33
9.5	Thermal chamber .....	34
9.6	Automatic lid opening .....	35
9.7	Start delay - of time .....	35
9.8	Start delay – of temperature .....	35
<b>10.</b>	<b>Menu .....</b>	<b>36</b>
10.1	Screen saver .....	37
10.2	Visual alarm .....	37
10.3	Types of main screen .....	37
10.3.1	Switching the normal display to simplified display .....	38
10.3.2	Switching the simplified screen to normal display .....	38
10.4	Rotating runtime .....	38
10.5	Buzzer .....	38
10.6	Language .....	39
10.7	Other .....	39
10.8	Password .....	40
10.9	Last 10 cycles .....	41
10.10	Work time .....	41
10.11	Rotor runtime .....	41
10.12	Contact us .....	42
10.13	Diagnostics .....	42
10.14	Factory settings .....	42
<b>11.</b>	<b>Maintenance .....</b>	<b>42</b>
11.1	Cleaning of the centrifuge .....	42
11.2	Maintenance of centrifuge elements .....	43
11.3	Sterilization .....	43
11.3.1	Autoclaving .....	44
11.4	Chemical resistance .....	45
<b>12.</b>	<b>Troubleshooting .....</b>	<b>46</b>
12.1	Messages .....	47
12.2	Emergency cover release .....	47
<b>13.</b>	<b>Guarantee .....</b>	<b>48</b>
<b>14.</b>	<b>Transport and storage .....</b>	<b>49</b>
<b>15.</b>	<b>Disposal .....</b>	<b>49</b>
<b>16.</b>	<b>List of changes in the manual .....</b>	<b>49</b>
<b>17.</b>	<b>Manufacturer’s info .....</b>	<b>50</b>
	<b>Distributor’s info .....</b>	<b>50</b>
<b>18.</b>	<b>ANNEXES .....</b>	<b>50</b>



- |   |   |
|---|---|
| A. Additional accessories                 | C. Declaration of decontamination (repair / return) |
| B. Declaration of conformity (CE, ROHS 2) | D. Nomogram RPM / RCF                               |

## 1. Symbols used in the manual and on the device

Symbol	Explanation
	<b>WARNING!</b> Warning of potential injury or health risk
	<b>WARNING!</b> Risk of crushing injury
	<b>DANGER!</b> Risk of electric shock with potential for severe injury or death as a consequence
	<b>DANGER!</b> Biohazard with potential for risk to health or death as a consequence
	<b>DANGER!</b> Risk of explosion with potential for severe injury or death as a consequence
	Symbol identifying a medical device for in vitro diagnostic use
	CE mark
	Symbol informing about the method of disposal
	Please read the instruction manual before you start working with the device
	Manufacturer's data

### 1.1 Markings on the device

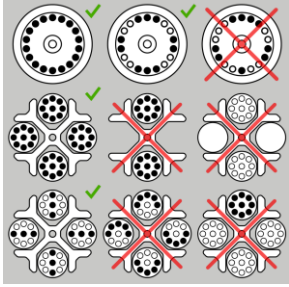
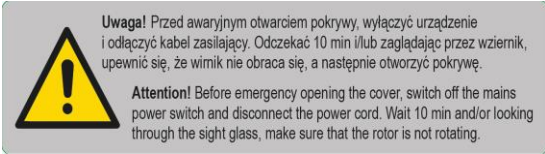
<i>Symbol</i>	<i>Explanation</i>	<i>Location</i>
	Information about the direction of rotation of the rotor	Under the centrifuge lid

	Reminder for proper rotor maintenance	Under the centrifuge lid
	Information about correct and incorrect filling of rotors	Under the centrifuge lid
	Information about the place of danger	On the side of the centrifuge next to the emergency opening of the lid
	Information reminding you to properly tighten the rotor screw	Under the centrifuge lid

## 2. Application

- **MPW-380, 380R** centrifuges are a family of table-top non-automatic laboratory centrifuges (MPW-380 – ventilated centrifuge, MPW-380R – refrigerated centrifuge).
- The devices are intended for In Vitro Diagnostics (IVD). This means that it is an in vitro diagnostic medical device - in accordance with the 2017/746 Regulation of the European Parliament and of the Council (EU) of 5 April 2017 on in vitro diagnostic medical devices and repealing Directive 98/79/EC and Commission Decision 2010 /227/EU.
- Centrifuges are used to separate aqueous solutions and suspensions of samples with a density not higher than **1.2g/cm<sup>3</sup>** taken from human, animal and plant organisms into components of different densities under the influence of centrifugal force, in order to provide information about their biological state and to other analytical work.
- The design of the centrifuge ensures ease of use, safe operation and a wide range of applications in medical, biochemical, and other analysis laboratories.
- The centrifuge is not biotight, therefore, when centrifuging preparations that require biotightness, containers and rotors with a biotightness certificate should be used.

### 3. Technical specification

manufacturer	"MPW MED. INSTRUMENTS" SPÓŁDZIELNIA PRACY, Boremłowska 46 Street, 04-347 Warsaw									
type	MPW - 380					MPW – 380R				
cat. number (REF)	10380/2-56	10380/1-56/100	10380/1-56/110	10380/1-56	10380/1-56/127	10380R/2-56	10380R/1-6/100	10380R/1-6/110	10380R/1-6	10380R/1-6/127
mains voltage (L1+N+PE)	230V ±10%	100V	110V	120V	127V	230V ±10%	100V	110V	120V	127V
mains frequency,	50/60Hz					50/60Hz	60Hz			
power consumption (max.)	800W					1400W				
current protection [A]	10A	12A				18A	20A			
cooling medium	-					R452A				
capacity (max.)	3000 ml									
speed – RPM	90 ÷ 18000 RPM (step 1 RPM)									
force – RCF	31876 x g (step 1 x g)									
kinetic energy (max.)	45000 J									
running time	00:00:01 ÷ 99:59:59 – [hours, min., sec] (step 1s)									
time counting	since start button is pressed / since preselected speed is reached									
short-time operation mode – SHORT	yes									
continuous operation mode – HOLD	yes									
menu languages	Polish, English, German, Spanish, Italian, Portuguese, Russian, Swedish, French, Czech									
user programs	100									
adjustable temperature	-					-20 ÷ 40°C* (step 1°C)				
cooling / heating	no / no					yes / no				
guaranteed temperature with max. rotor speed	-					≤4°C				
cooling	no					yes				
cooling without centrifuging	no					yes				
acceleration (ACEL)	10 linear curves									
deceleration (DECEL)	10 linear curves									
programmable non-linear curves:										
acceleration						10				
deceleration						10				
USB communication	no									
Electromagnetic compatibility	according to EN 61326-2-6:2006									
degree of protection (according to PN-EN 60034-5:2021-01)	IP21					IP21				
height (H)	455 mm					455 mm				
width (W)	515 mm					715 mm				
depth (D)	650 mm					650 mm				
height with open cover (H <sub>oc</sub> )	960 mm					960 mm				
noise level	<67 dB									
weight 230V	approx. 76 kg					approx. 114 kg				
weight 120V	approx. 81,5 kg					approx. 120 kg				

\*time and possibility of obtaining a set temperature is dependent on multiple factors , including rotor type, established RPM, ambient temperature; accuracy: - ±1°C appropriate for place of temperature sensor

#### 3.1 Environmental conditions

- The device may only be used indoors.
- The permissible ambient temperature is 2°C to 40°C.
- Maximum allowed relative humidity 80% at temperature up to 31°C decreasing linearly to 50% relative humidity at 40°C.
- The mains voltage fluctuations must not exceed ± 10% of the nominal voltage.
- Maximum altitude 2,000 m above sea level.
- Overvoltage category II.
- Pollution degree 2.

## 4. Installation

### 4.1 Content of the package

name	pcs.	cat no.
centrifuge MPW-380/R (type and supply version dependent)	1	10380/2-56; 10380/1-56; 10380/1-56/100; 10380/1-56/110; 10380/1-56/127  10380R/2-56; 10380R/1-6; 10380R/1-6/100; 10380R/1-6/110; 10380R/1-6/127
rotor fixing screw	1	17798
rotor key / emergency opening of the cover	1	17799
power cord 230V / 120V	1	17009/17010
vaseline 20ml	1	17201
user manual	1	See page 1



### 4.2 Location selection

	<p><b>WARNING! Risk of damage to the device.</b></p> <ul style="list-style-type: none"> <li>▪ The table intended for the centrifuge operation should be adapted to the weight of the device, clean, stable and free from vibrations, and have a flat, levelled top.</li> <li>▪ In accordance with the EN 61010-2-020 standard, leave a safety distance of 30 cm from the operating device. Keep a distance from walls and other devices. Do not place any objects in this area.</li> <li>▪ The centrifuge should be positioned so that access to the mains switch is not difficult.</li> <li>▪ Do not use the device near strong, unshielded, high-frequency electromagnetic sources as they may interfere with its proper operation.</li> <li>▪ Do not install the centrifuge near heat sources (e.g. radiators).</li> <li>▪ Avoid direct sunlight.</li> <li>▪ Ensure adequate ventilation of the room.</li> </ul>
---	---

### 4.3 Preparation for installation

	<p><b>WARNING! Risk of injury or damage to the device.</b></p> <ul style="list-style-type: none"> <li>▪ After changing the storage location of the device (from cold to warm), wait until the device warms up to ambient temperature to avoid damage to electronic components due to condensation.</li> <li>▪ It is important to allow enough time for the device to dry before restarting it (min. 4 hours).</li> <li>▪ Lifting and carrying the device may result in injuries due to its heavy weight.</li> <li>▪ The centrifuge should be lifted and transported with a sufficient number of people (min. 2). Use a transport aid to move the centrifuge.</li> <li>▪ Lift the device from below, near its feet.</li> </ul>
---	---



 	<p><b>WARNING! Risk of electric shock or fire.</b></p> <ul style="list-style-type: none"> <li>▪ The centrifuge may only be operated in a building that complies with applicable national regulations and standards. In particular, it must be ensured that power supply circuits located upstream of the device's internal protection are not loaded in an unauthorized manner. This can be ensured by using additional interrupters or other suitable fuse elements in the building installation.</li> <li>▪ The voltage and frequency of the power source must comply with the requirements specified on the <b>device nameplate</b>.</li> <li>▪ The power socket must be earthed with a protective conductor (PE).</li> <li>▪ During operation, there must be easy access to the power switch and the device that cuts off the electrical network (e.g. residual current device).</li> <li>▪ Only the power cord included with the centrifuge can be used.</li> <li>▪ Before turning on the device, make sure it is properly connected to the power source.</li> </ul>
--	---

- 1) Open the package.
- 2) Remove the box containing the accessories.
- 3) Remove the centrifuge from the box and remove the foil (keep the packaging and packing material for service shipment).
- 4) Place the device on a suitable laboratory table.



#### 4.4 Centrifuge installation

- 1) Check whether the mains voltage and frequency meet the requirements given on the nameplate of the device.
- 2) Connect the power cord to the centrifuge power socket (on the rear wall of the centrifuge) and to the power source.

#### 4.5 Starting the centrifuge

- 1) Wait at least 4 hours for the unit to reach ambient temperature to avoid compressor failure or damage to electronic components due to condensation.
- 2) Turn on the centrifuge power using the mains switch located on the side wall of the device.
- 3) Open the cover according to the section **Opening and closing the cover**.
- 4) Install the rotor according to the section **Placing the rotor and accessories in the centrifuge**.
- 5) Set centrifugation parameters according to the sections **Centrifuging** and **Parameters of centrifugation** Parameters of centrifugation.

#### 4.6 Opening and closing the cover

	<p><b>ATTENTION !</b></p> <ul style="list-style-type: none"> <li>▪ The cover can only be opened when the centrifuge is at rest (the rotor is not rotating).</li> <li>▪ Centrifugation can only be started with the lid closed.</li> </ul>
	<p><b>WARNING! Risk of injury.</b></p> <ul style="list-style-type: none"> <li>▪ Do not put your hands between the cover and the housing when closing the centrifuge cover.</li> </ul>

- 1) Press the **COVER** button  to open the cover.
- 2) To close the cover, press it down with both hands until the lock engages.

#### 4.7 Current protection

	The centrifuge is equipped with thermal current protection. Fuse is situated in the power switch (without an additional fuse).
---	--

### 5. Safety notes

#### 5.1 General remarks

	<ul style="list-style-type: none"> <li>▪ The laboratory centrifuge may be operated only by qualified laboratory personnel, after reading the operating manual.</li> <li>▪ The operating instructions are part of the product.</li> <li>▪ The operating manual should always be kept in the vicinity of the centrifuge.</li> <li>▪ The centrifuge cannot be operated contrary to its purpose.</li> <li>▪ If the centrifuge is used in a manner inconsistent with the manufacturer's guidelines, the safety of its use may be impaired.</li> <li>▪ For centrifugation in the centrifuge, only containers and inserts provided in the list of equipment and centrifuge tubes, the diameter, length and strength of which are appropriate, should be used. The use of test tubes not included in the list should be agreed with MPW MED. INSTRUMENTS or its authorized representatives.</li> <li>▪ Pay attention to the quality and appropriate thickness of the glass test tubes walls. Glass tubes should be centrifuge tubes, and their use in the centrifuge should be made dependent on the following guidelines:</li> </ul> <table border="1" data-bbox="341 1149 1350 1296"> <thead> <tr> <th>glass tubes</th> <th>max RCF in angular rotors</th> <th>max RCF in horizontal rotors</th> </tr> </thead> <tbody> <tr> <td>5-10 ml</td> <td>3000 x g</td> <td>4000 x g</td> </tr> <tr> <td>30-100 ml</td> <td>spinning not allowed</td> <td>4000 x g</td> </tr> </tbody> </table> <ul style="list-style-type: none"> <li>▪ Weighing the filled test tubes into the rotor is recommended. When centrifuging in horizontal rotors, it is recommended to weigh the filled containers / hangers. This will allow to minimize the differences in mass between them, and as a result to avoid the negative impact of vibrations on the engine suspension and to reduce noise levels during the operation of the centrifuge.</li> </ul>	glass tubes	max RCF in angular rotors	max RCF in horizontal rotors	5-10 ml	3000 x g	4000 x g	30-100 ml	spinning not allowed	4000 x g
glass tubes	max RCF in angular rotors	max RCF in horizontal rotors								
5-10 ml	3000 x g	4000 x g								
30-100 ml	spinning not allowed	4000 x g								

#### 5.2 Placing the rotor and accessories in the centrifuge

	<ul style="list-style-type: none"> <li>▪ Connect the centrifuge to the power supply (mains socket at the back of the centrifuge).</li> <li>▪ Turn on the centrifuge (switch on the side of the centrifuge).</li> <li>▪ Open the cover of the centrifuge by pressing the COVER key. Before installing the rotor, check that the rotating chamber is free from any contamination. If there is dust, glass splinters, liquid residues, etc., remove them.</li> <li>▪ The rotor can fall if not handled properly, therefore it should always be handled and placed in the centrifuge using both hands.</li> <li>▪ Place the rotor on the motor axis by sliding it onto the cone as far as it will go (keeping the coaxiality between the rotor and the motor axis).</li> <li>▪ Screw the screw fixing the rotor into the motor axis (clockwise), and then tighten it firmly with the rotor key.</li> </ul>
---	--

	<ul style="list-style-type: none"> <li>Fill the rotor with containers / hangers / test tubes according to recommendations in section <b>Filling the rotor</b>.</li> <li>In order to replace the rotor, first remove the tubes and containers from it, unscrew the screw fixing the rotor with the enclosed rotor key, counterclockwise, then using both hands, grab the rotor on opposite sides and remove it from the motor axis.</li> <li>Install another rotor as described above instructions.</li> </ul>
--	---

### 5.3 Filling tubes

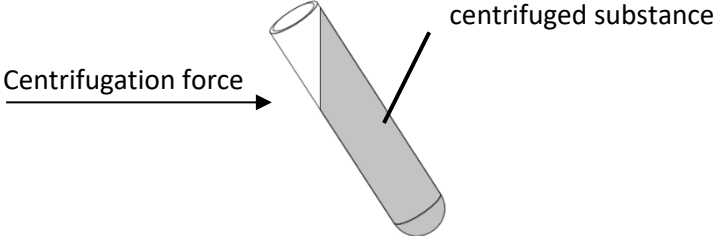
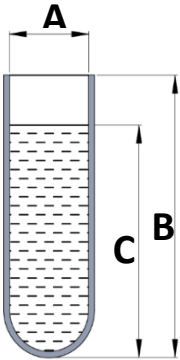
	<ul style="list-style-type: none"> <li>Fill test tubes outside the centrifuge.</li> </ul> <div style="text-align: center;">  </div> <ul style="list-style-type: none"> <li>If the manufacturer of the test tube has not specified the maximum level, fill the test tubes so that the centrifuged substance does not run out of the vessel during centrifugation. To do this, use the formula below:</li> </ul> <div style="text-align: center;">  </div> <div style="text-align: center; margin-top: 10px;"> <math display="block">C &lt; B - \frac{A}{2}</math> </div> <p style="margin-left: 40px;"> <b>A</b> – internal tube diameter  <b>B</b> – tube height  <b>C</b> – max liquid level         </p>
---	--

### 5.4 Filling the rotor

#### 5.4.1 Angular rotors

	<p><b>CAUTION!</b></p> <ul style="list-style-type: none"> <li>Angle rotors must be used with a suitable cover which must be screwed securely onto the rotor. The rotor and the cover are marked with the same catalog number (REF) to eliminate the risk of incorrect selection when you have several types of rotors.</li> </ul>
---	---

	<ul style="list-style-type: none"> <li>Check that the impeller is seated correctly and firmly bolted to the motor shaft.</li> <li>Do not exceed the maximum rotor load (information is provided on the rotor).</li> </ul> <p style="text-align: center;"><b>An example of the marking on the angular rotor:</b></p>
---	---

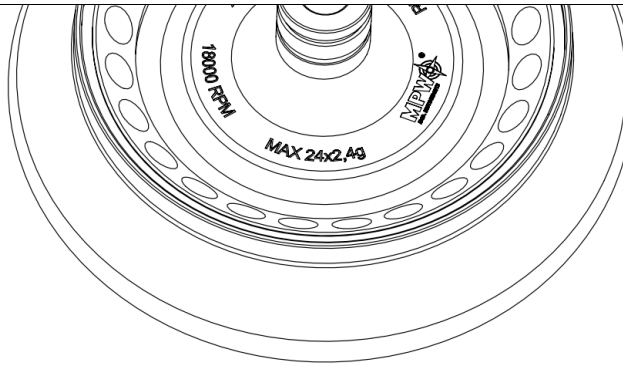

**MAX. 24x2,4g** - means the possibility of placing 24 test tubes in the rotor, each weighing 2.4 g.

- To ensure symmetrical loading, insert test tubes of the same type and weight in pairs into opposite openings of the rotor. If reduction inserts are used, they should also be placed in the holes opposite to each other in pairs of the same type.

**Examples of correct and incorrect arrangement of test tubes in the rotor:**

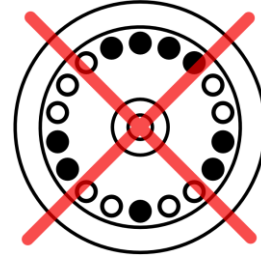
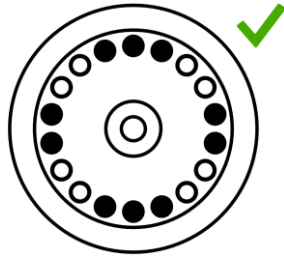
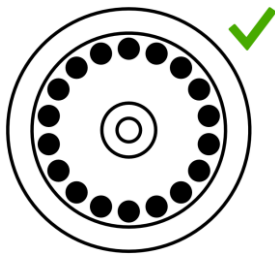

#### 5.4.2 Horizontal rotors

- Check that the impeller is seated correctly and firmly bolted to the motor shaft.
- Make sure that the rotor pins and grooves of the containers / hangers are clean, and then it is necessary to lubricate them with the technical petroleum jelly supplied with the device (catalog number 17201).
- Place the containers / hangers in the rotor.
- Horizontal rotors must be filled with a set of containers / hangers.
- Observe the limitations for the permissible centrifugal mass stated on the rotor and container. If the marking appears on the rotor, it refers to the mass of the substance to be centrifuged, and if on the container it refers to the mass of the contents of the container, i.e. insert, test tube and the substance contained in it.

**Examples of markings on horizontal rotors and containers:**

**Marking on the rotor**

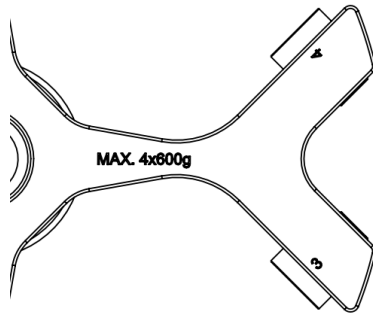

**Marking on the container**



**MAX. 4x600g** – permissible weight of the contents of the test tubes placed in each of the 4 containers

**MAX. 290g** – maximum weight of the contents of the container

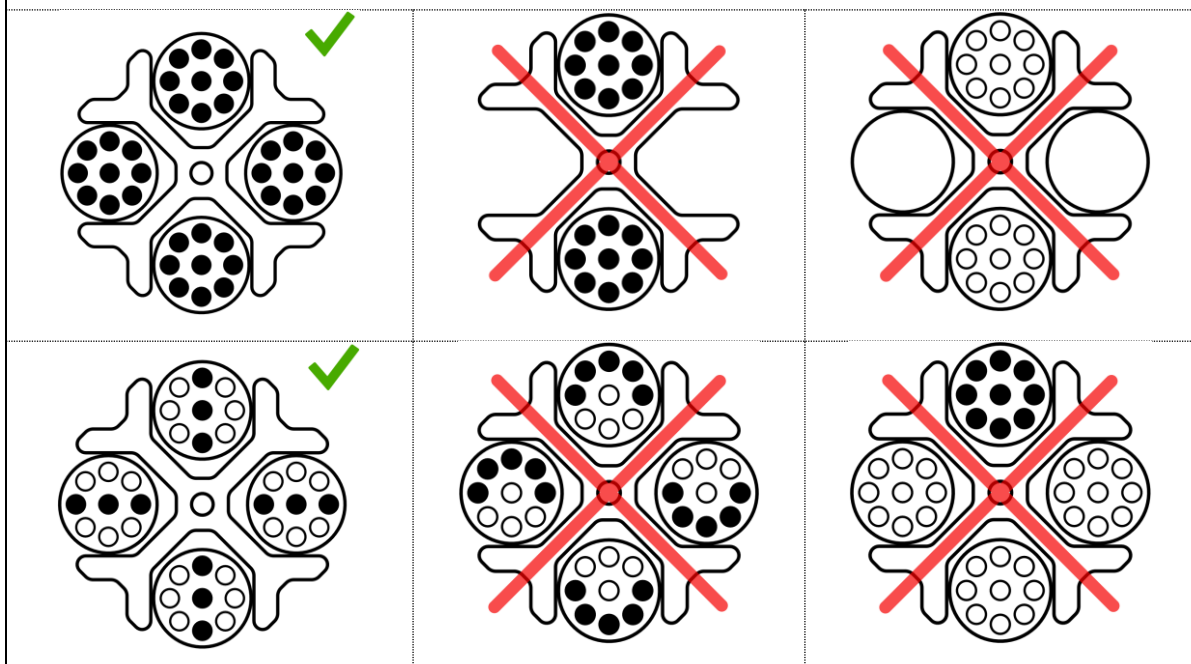

- In order to ensure symmetrical and even rotor load, try to fill opposite seats with containers / hangers of the same type and weight.
- Tubes should be placed symmetrically facing each other.
- Before starting the centrifugation, check that all containers / hangers are properly placed in the rotor and can swing freely.
- For this purpose, empty test tubes should be placed in containers. Manually tilt the containers to the horizontal position and check that there are no collisions between the tubes, containers / hangers and the rotor.

**Examples of correct and incorrect arrangement of test tubes in the rotor:**





**5.5 Safety hints**

	<p><b>ROTOR MAINTENANCE</b></p> <ul style="list-style-type: none"> <li>▪ In order to increase the durability of gaskets, threaded places, rotor pins, undercuts for pins in containers, they must be cleaned, and then it is necessary to lubricate them with the technical petroleum jelly supplied with the device (catalog number 17201).</li> <li>▪ Use only accessories that are in good technical condition.</li> </ul>
--	---

	<p><b>HU EQUIPMENT MAINTENANCE</b></p> <ul style="list-style-type: none"> <li>Make sure the sealing rings (rubber) are lightly coated with grease to maintain tightness. Use high vacuum silicone grease, eg type "C" by LUBRINA.</li> </ul>
	<p><b>HAZARDOUS MATERIALS</b></p> <ul style="list-style-type: none"> <li>Infectious materials should be centrifuged only in containers / rotors with covers.</li> <li>It is not allowed to centrifuge toxic or infectious materials if the rotor or test tube seal is damaged.</li> <li>Appropriate disinfection procedures should always be carried out, if hazardous substances have contaminated the centrifuge or its accessories.</li> </ul>
	<p><b>EXPLOSIVE, FLAMMABLE MATERIALS</b></p> <ul style="list-style-type: none"> <li>It is not allowed to centrifuge explosive and inflammable materials.</li> <li>Do not centrifuge substances that could create a potentially explosive atmosphere as a result of the high energy supply during centrifugation.</li> <li>The centrifuge must not be used in an explosive atmosphere.</li> <li>It is not allowed to centrifuge materials that may generate flammable or explosive mixtures when exposed to air.</li> </ul>

## 5.6 Operating conditions

	<p><b>GENERAL REMARKS</b></p> <ul style="list-style-type: none"> <li>Only original equipment of centrifuges and spare parts should be used.</li> <li>In case of a malfunction of the centrifuge, the MPW MED factory service should be used. INSTRUMENTS or its authorized representatives.</li> <li>It is not allowed to start the centrifuge if it is not installed correctly or the rotor and accessories are not properly mounted.</li> <li>The centrifuge must not be transported with the rotor installed on the motor shaft.</li> <li>Fill the rotor equipment to the same weight in order to prevent unbalance of the centrifuge (point <b>Filling the rotor</b>).</li> </ul>
---	---

	<p><b>START-UP</b></p> <ul style="list-style-type: none"> <li>Before switching on the device, carefully read all sections of this manual in order to ensure the correct operation of the device and to avoid damage to the device or its accessories.</li> </ul>
---	--

	<p><b>CENTRIFUGAL SUBSTANCES</b></p> <ul style="list-style-type: none"> <li>Rotors are designed for centrifuging liquids with an average density of <b>1.2 g / cm<sup>3</sup></b> or less. This applies to centrifugation at maximum speed. If liquids with a higher density are to be used, be sure to enter the density value in the <b>PARAM / DENSITY</b> tab in order to reduce the available spin speed.</li> </ul>
---	---



## 5.7 Equipment life

	<ul style="list-style-type: none"> <li>Each spin cycle in which the rotor has accelerated and decelerated is considered a duty cycle, independent of speed and duration.</li> <li>Do not use the equipment after the allowable number of cycles or after the maximum service life has passed, whichever comes first (the service life is <b>15000 cycles</b> or <b>5 years</b>).</li> </ul>
--	---

## 5.8 Work safety

The centrifuge should be inspected by an authorized service at least once a year (after the warranty period). Special circumstances, e.g., corrosive environment, may be the reason for more frequent checks. Tests should end with issuing a validation protocol, which specifies checking the technical condition of a laboratory centrifuge.

It is recommended to create a document that records all repairs and inspections. This document should be kept in the place where the centrifuge is used.

	<p><b>CONTROLS CONDUCTED BY THE OPERATOR</b></p> <ul style="list-style-type: none"> <li>▪ The operator must pay attention to the fact that the parts of the centrifuge, important from the safety point of view, are not damaged. This remark applies to:             <ul style="list-style-type: none"> <li>▪ Centrifuge accessories, especially structural changes, corrosion, initial cracks, abrasion of metal parts.</li> <li>▪ Bolted connections.</li> <li>▪ Inspection of rotor and container seals, if any. Particular attention should be paid to rubber elements (seals). In the event of any damage or visible structural changes, they should be immediately replaced with new ones.</li> <li>▪ Control of the performance of annual post-warranty inspections of the technical condition of the centrifuge.</li> </ul> </li> </ul>
	<ul style="list-style-type: none"> <li>▪ During centrifugation, it is not allowed to lift, shift the centrifuge or rest on it.</li> <li>▪ During centrifugation one must not stay in the safety zone, i.e., 30 cm distance around the centrifuge, nor leave any objects, e.g., glass vessels, inside this zone.</li> <li>▪ It is not allowed to put any objects on the centrifuge.</li> </ul>
	<p><b>OPENING THE COVER DURING SPINNING</b></p> <ul style="list-style-type: none"> <li>▪ It is not allowed to use the emergency cover opening during centrifuging, because it may result in loss of health or life.</li> </ul>
	<p><b>HANDLING OF ROTORS</b></p> <ul style="list-style-type: none"> <li>▪ It is not allowed to use accessories (rotors, lids, containers, hangers and round carriers) with signs of corrosion or other mechanical damage.</li> <li>▪ It is not allowed to centrifuge substances of high corrosive aggressiveness, which may damage the materials and reduce the mechanical properties of rotors, buckets and round carriers.</li> <li>▪ It is not allowed to centrifuge rotors with removed or loose covers.</li> </ul>

## 5.9 Unbalance

	<p>Unbalance causes noise, vibration during operation and has a negative effect on the driveline (engine and suspension). The more precisely the process of balancing the feed to the rotor is carried out, the smoother the centrifuge will run and the longer the useful life of the drive system will be. Moreover, thanks to the correct balancing, an excellent level of separation of the centrifuged substance is achieved since the separated components will not be picked up again by vibrations.</p>
---	---

The centrifuge is equipped with a rotor imbalance sensor. In the event of its activation, the centrifugation process is stopped by quick braking and an error message is displayed. Erasing the error message is possible by pressing one of the following buttons: **BACK, STOP, COVER, SET** and **▲ ▼ ◀▶**.

Make sure that the rotor has been properly loaded - places in the rotor must be equipped with identically filled containers, inserts and test tubes so as to obtain the best possible weight balance (see chapter Filling the rotor). If necessary, correct the load distribution and / or, in the case of horizontal rotors, clean and lubricate the rotor pins, then restart the spin.

### **5.10 Emergency stop**

At any time during centrifugation, it is possible to interrupt the process and stop the centrifugation with the fastest rotor characteristics. This is done by pressing the stop button twice (**2x STOP**).

Pressing the **STOP** key once will stop the spinning with the braking characteristics set in the program. The message about interrupted centrifuging can be canceled with the following buttons: **BACK, STOP, COVER, SET** and ▲ ▼ ◀ ▶.

### **5.11 Residual risk**

The centrifuge is built according to the state-of-the-art and the recognized safety regulations. Nevertheless, still remain some level of residual risk due to improper operation and malfunctions. It is possible to decrease residual risk by strictly applying user manual conditions and correcting malfunction which could threaten safety, immediately

### **5.12 Obligation to report a serious device incident**

Any serious incident related to the device should be reported to the manufacturer and the competent authority of the Member State where the user or patient resides.



## 6. Product description

### 6.1 Product Design and Appearance

A new generation of MPW MED. INSTRUMENTS laboratory centrifuges is provided with state-of-the-art microprocessor control systems, durable and quiet asynchronous brushless motors, and accessories consistent with requirements of the present-day user.

The centrifuge has rigid self-supporting structure. Housing was made of sheet aluminum, back made of steel sheet. Front and cover were made of ABS type plastic. Cover is fixed on steel hinges and from the front it is locked with two electromagnetic locks blocking possibility of opening during centrifugation. Rotation chamber casing was made of thick steel sheet. The spin chamber is made of stainless-steel sheet.

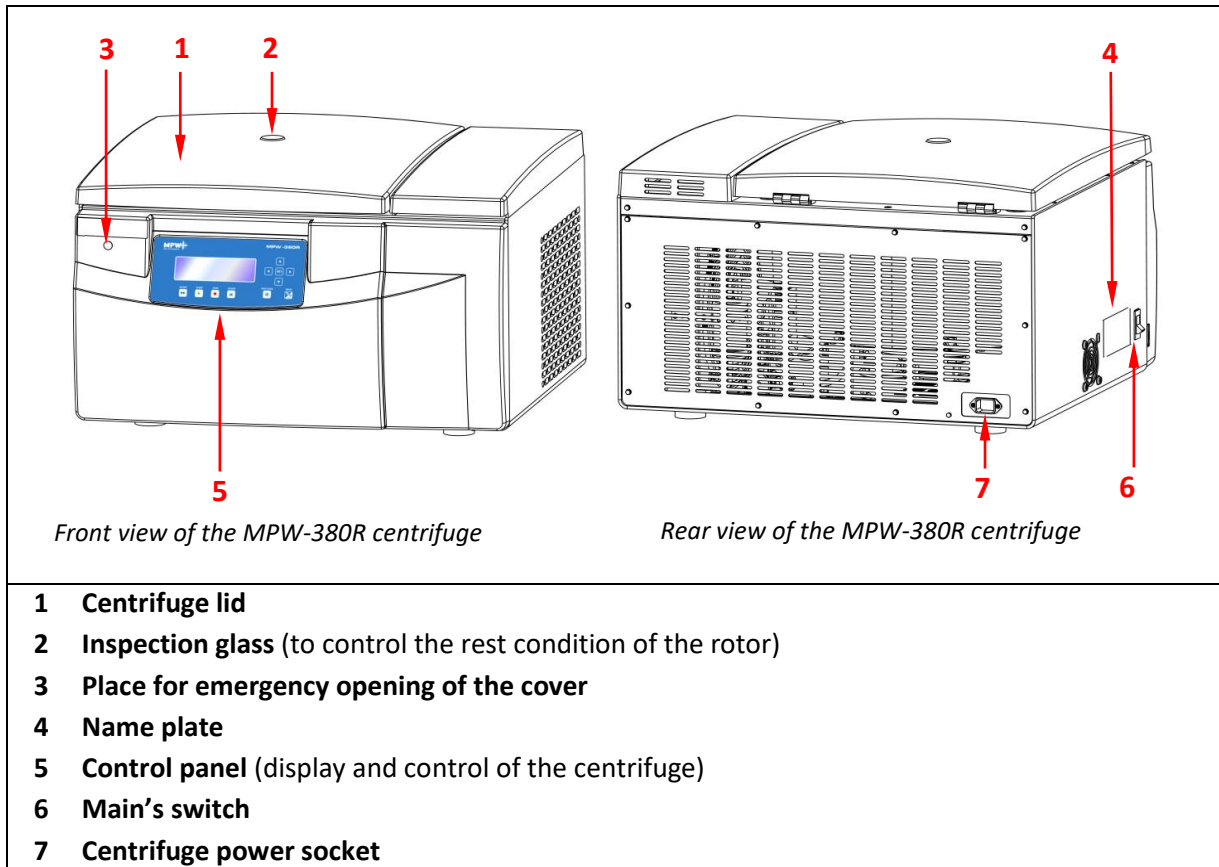

## 6.2 Name plate

Data regarding the device should be read from the nameplate located on the side wall of the centrifuge next to the power switch (the image below is an example).

The nameplate for the MPW-380R centrifuge contains the following information:

- 1** Model: MPW-380R
- 2** REF: 10380R/2-56
- 3** n: 18000 rpm
- 4** AC: 230 V
- 5** P: 1400 W
- 6** Kinetic energy: 45000 J
- 7** SN: 10380R000124
- 8** CE, IVD, and other approval marks
- 9** Rated frequency: 50-60 Hz
- 10** Current protection: 18 A
- 11** MPW MED. INSTRUMENTS logo
- 12** Manufacturer's information: "MPW MED. INSTRUMENTS" SPÓŁDZIELNIA PRACY, ul. Boremłowska 46, 04-347 Warszawa, POLAND
- 13** Refrigerant information: R452A / 0,6 kg / 1,29 t eq CO<sub>2</sub> / GWP 2141 / 27 bar fluorinated greenhouse gas in hermetically sealed refrigeration system
- 14** Max. density: 1,2 g/ml
- 15** UDI code carrier (data matrix) with human-readable presentation (HRI)
- 16** Date of production: 2024-01-08

<ul style="list-style-type: none"> <li><b>1</b> Centrifuge model</li> <li><b>2</b> Catalog number</li> <li><b>3</b> Maximum speed</li> <li><b>4</b> Rated voltage</li> <li><b>5</b> Maximum rated power</li> <li><b>6</b> Kinetic energy</li> <li><b>7</b> Serial number</li> <li><b>8</b> Approval marks and symbols (explained in chapter 1)</li> </ul>	<ul style="list-style-type: none"> <li><b>9</b> Rated frequency</li> <li><b>10</b> Current protection</li> <li><b>11</b> Manufacturer's logo</li> <li><b>12</b> Manufacturer's information</li> <li><b>13</b> Information about the refrigerant (refrigerated centrifuges only)</li> <li><b>14</b> Density of centrifuged substance</li> <li><b>15</b> UDI code carrier – data matrix (AIDC) with human-readable presentation (HRI)</li> <li><b>16</b> Date of production</li> </ul>
---	--

## 6.3 Control device

The microprocessor control unit of the centrifuge ensures broad possibilities of providing, realization and reading of work parameters.

## 6.4 Setting parameters

Data setting and read-out system forms hermetically closed keyboard with distinctly accessible operation points. Easily readable displays signalling individual performed operations facilitate operator's programming and recording of parameters and condition of the centrifuge.

## 6.5 Safety features

### Cover lock

The centrifuge can be started only with properly closed cover. While the cover can be opened only after stopping the rotor. In case of emergency opening of the cover during operation, the centrifuge drive will be immediately switched-off and the rotor will brake till complete stopping.



### Unbalance detecting

When loads of opposite buckets or carriers in rotors are unbalanced, the drive will be switched-off during acceleration or operation of the centrifuge – and the error message will be displayed.

### Rotor verification and checking compatibility with loaded program

Directly after starting centrifuging, a unit verifies the type of the rotor applied and in the case of its incompatibility with the type indicated in the application or absence of the rotor, the spinning process shall be stopped with simultaneous displaying the error message. The conformity of the type of the rotor is signalled with a single audible signal. In case autoidentification (see 9.8 Other) option is checked, proper rotor will be automatically chosen, without user engagement.

### ***Rest state inspection***

Opening the centrifuge lid with the **COVER** key is possible only when the rotor is at rest. Check that the symbol  described in the **Display** chapter is visible on the screen. Use the sight glass on the cover to make sure the impeller is not turning. When the rotor brakes, the symbol  described in the **Display** section is visible. Emergency opening of the cover during rotor spinning is not allowed.

### ***Checking of excessive temperature***

If temperature in rotation chamber exceeds 50°C (MPW-380R) caused by, for example, malfunction of cooling system, drive will be switched off and error message will be displayed. The reboot is only possible after chilling device.

### **6.6 *Increase in temperature (MPW-380 only)***

In uncooled centrifuges, the temperature in the rotor chamber, rotor and sample can increase to above 40°C, based on the run time, g-force (rcf)/speed and ambient temperature.

## 7. Centrifuging

Power switching ON/OFF is carried out with master switch situated on the left side wall of the centrifuge. All settings on the centrifuge are done by means of the control panel.

### 7.1 Control panel

The control panel placed on the front casing serves the purpose of controlling centrifuge operation.

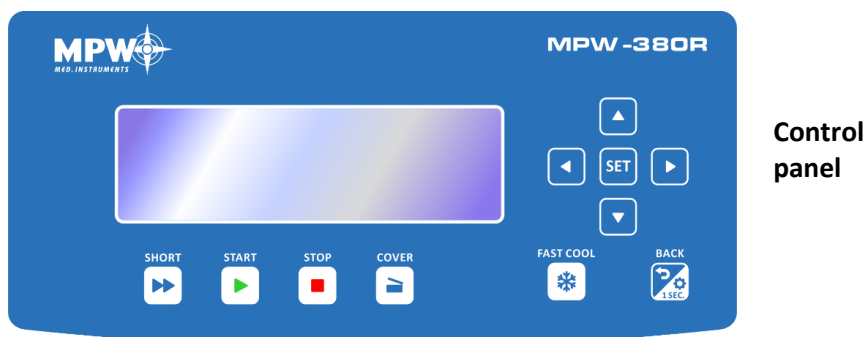

	SHORT <sup>1</sup>	short-time centrifuging
	START	start centrifugation run
	STOP <sup>2</sup>	end centrifugation run
	COVER	cover opening
	FAST COOL	start fast cooling mode (MPW-380R only)
	BACK/ OPTIONS	exit the current menu / enter to submenu of options (keep held down within 1 s.)
	UP	navigation in menu / increasing values
	DOWN	navigation in menu / decreasing values
	LEFT	navigation in menu
	RIGHT	navigation in menu
	SET	changing parameters / confirming changes

<sup>1</sup> the centrifuge is working as long as the key is pressed

<sup>2</sup> first-time pressing press – will make stopping centrifuging with acceleration characteristics set in the current program, second-time pressing – will make the centrifuging as fast as possible (quickest characteristic). During setting of the parameters, it serves for exiting zones on the primary screen without introducing changes.

### 7.2 Display

The display is located in the centre of the control panel. The main screen variants are presented below. In the user manual exemplary screens from MPW-380R are shown. For MPW-380 (without refrigeration) temperature is not shown. Blinking of field on display mean it is ready to set. Blinking of field is visualised as highlighted in the user manual.

	<p>After switching on centrifuge, welcome screen appears. After disappearing the welcome screen, it is possible to setting up parameters.</p>
--	---

	<p><b>Simplified</b> display mode is set as default, there is possible to switch to <b>normal</b>.</p>
	<p><b>Normal</b> display contains an expanded number of settings visible during operation.</p>
<p>Detailed information on display modes is provided in chapter <i>Types of main screen</i>.</p>	

<b>SPEED</b>	rotor speed	assigned/measured
<b>RCF</b>	relative centrifugal force	assigned/measured
<b>TIME</b>	centrifuging time	assigned/measured
<b>TEMP</b>	temperature	assigned/measured
<b>PRG</b>	program no.	
<b>11199</b>	rotor no.	
<b>PARAM</b>	parameters of the centrifuge	
<b>MENU</b>	configuration menu	



	changing values		
	user multi sections curve		
	density > 1,2 g/cm <sup>3</sup>		
	centrifuging radius changed		
	counting time down (decreasing)		counting time up (increasing)
	cooling to assigned temperature		
	FAST COOL mode cooling		
	centrifuging		centrifuging (with automatic cover opening)
	rotor stopped / closed cover		rotor stopped / opened lid
	braking		fastest decelerating
	rotor identification		
	thermal chamber		
	temperature delay		
	time delay		
	drop-down list		
	temporarily disabled		
	locked		
	time counting (blinking)		
	disabled option		active option

### 7.3 Setting up RPM, RCF, time, temperature



On the main screen, it is possible to set:

rotating speed - RPM	<b>SPEED</b>
relative centrifugal force (multiple of g-force)	<b>RCF</b>
centrifuging time	<b>TIME</b>
centrifuging temperature	<b>TEMP</b>



Exemplary change of **SPEED** setting:

	<ul style="list-style-type: none"> <li>▪ Press <b>SET</b> (to enter edit mode) –  appears.</li> <li>▪ Via <b>▲▼◀▶</b> keys mark <b>SPEED</b> field (blinking).</li> <li>▪ Press <b>SET-</b> blinking.</li> <li>▪ Via <b>◀▶</b> choose order of magnitude of changing value (blinking).</li> <li>▪ With <b>▲▼</b> choose demanded value.</li> <li>▪ Repeat above two steps for other orders of magnitude.</li> <li>▪ Confirm settings by pressing <b>SET</b>.</li> <li>▪ Press <b>BACK</b>.</li> </ul>
<ul style="list-style-type: none"> <li>▪ When RPM is changed, RCF is automatically corrected.</li> </ul>	

Exemplary change of **RCF** setting:



	<ul style="list-style-type: none"> <li>▪ Press <b>SET</b> (to enter edit mode) –  appears.</li> <li>▪ Via <b>▲▼◀▶</b> keys mark <b>RCF</b> field (blinking).</li> <li>▪ Press <b>SET-</b> blinking.</li> <li>▪ Via <b>◀▶</b> choose order of magnitude of changing value (blinking).</li> <li>▪ With <b>▲▼</b> choose demanded value.</li> <li>▪ Repeat above two steps for other orders of magnitude.</li> <li>▪ Confirm settings by pressing <b>SET</b>.</li> <li>▪ Press <b>BACK</b>.</li> </ul>
<ul style="list-style-type: none"> <li>▪ When RCF is changed, RPM is automatically corrected.</li> </ul>	

Exemplary change of **TIME** setting:

	<ul style="list-style-type: none"> <li>Press <b>SET</b> (to enter edit mode) -  appears.</li> <li>Via <b>▲▼◀▶</b> keys mark <b>TIME</b> field (blinking).</li> </ul>
<p style="text-align: center;">00:02:00 [hh : mm : ss]</p> <p>e.g.: centrifuging time – 2 minutes 00 seconds</p>	<ul style="list-style-type: none"> <li>Press <b>SET</b>  blinking.</li> <li>Via <b>◀▶</b> choose order of magnitude of changing value (blinking).</li> <li>With <b>▲▼</b> choose demanded value.</li> <li>Repeat above two steps for other orders of magnitude.</li> <li>Confirm settings by pressing <b>SET</b>.</li> <li>Exit edit mode by pressing <b>BACK</b>.</li> </ul>
00:02:00	set value
02:00	current value (most significant digits)

<b>HOLD</b> mode	continuous run mode
	<ul style="list-style-type: none"> <li>To run centrifuging in <b>HOLD</b> mode set <b>00:00:00</b> time.</li> <li>To end centrifuging in <b>HOLD</b> mode press <b>STOP</b>.</li> </ul>

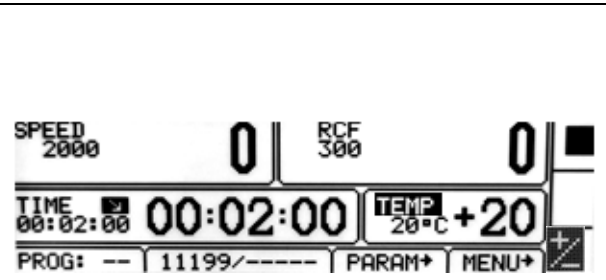
Exemplary change of **TEMP** setting:

	<ul style="list-style-type: none"> <li>Press <b>SET</b> (to enter edit mode) -  appears.</li> <li>Via <b>▲▼◀▶</b> keys mark <b>TEMP</b> field (blinking).</li> <li>Press <b>SET</b> key.</li> <li>With <b>▲▼</b> choose demanded value [-20°C÷40°C].</li> <li>Confirm settings by pressing <b>SET</b>.</li> <li>Press <b>BACK</b>.</li> </ul>
---	--

#### 7.4 Users programs

	<p>After switching centrifuge on, program that was used in previous session is being loaded. If any program was not used in previous session, centrifuge resume the last chosen parameters.</p>
---	---

**Program choosing:**

Entering the program selection mode for the **simplified display**:

	<ul style="list-style-type: none"> <li>Press and hold  by 1 second.</li> <li>Choose <b>PROG</b> with ▲ ▼</li> <li>Press <b>SET</b>.</li> </ul>
--	--

Entering the program selection mode for the **normal display**:

	<ul style="list-style-type: none"> <li>Press <b>SET</b> key –  appears.</li> <li>Via ▲ ▼ ◀ ▶ keys mark <b>PRG-</b> – field (highlighted)</li> <li>Press <b>SET</b> key – list of programs is visible.</li> </ul>
--	--

**Program selection mode tab:**

<table border="1"> <thead> <tr> <th>No</th> <th>SPEED</th> <th>RCF</th> <th>TIME</th> <th>TEMP</th> <th>ACC</th> <th>DEC</th> <th>ROT</th> </tr> </thead> <tbody> <tr> <td>0</td> <td>4590</td> <td>2826</td> <td>HOLD</td> <td>20</td> <td>0</td> <td>0</td> <td>11740</td> </tr> <tr> <td>1</td> <td>4590</td> <td>2826</td> <td>00:01:00</td> <td>20</td> <td>0</td> <td>0</td> <td>11740</td> </tr> <tr> <td>▶ 2</td> <td>5090</td> <td>3476</td> <td>00:02:00</td> <td>20</td> <td>0</td> <td>0</td> <td>11740</td> </tr> <tr> <td>3</td> <td></td> <td></td> <td></td> <td></td> <td></td> <td></td> <td></td> </tr> <tr> <td>4</td> <td></td> <td></td> <td></td> <td></td> <td></td> <td></td> <td></td> </tr> <tr> <td>5</td> <td></td> <td></td> <td></td> <td></td> <td></td> <td></td> <td></td> </tr> </tbody> </table>	No	SPEED	RCF	TIME	TEMP	ACC	DEC	ROT	0	4590	2826	HOLD	20	0	0	11740	1	4590	2826	00:01:00	20	0	0	11740	▶ 2	5090	3476	00:02:00	20	0	0	11740	3								4								5								<ul style="list-style-type: none"> <li>Via ▲ ▼ choose demanded program.</li> <li>Confirm with <b>SET</b> key.</li> </ul>
No	SPEED	RCF	TIME	TEMP	ACC	DEC	ROT																																																		
0	4590	2826	HOLD	20	0	0	11740																																																		
1	4590	2826	00:01:00	20	0	0	11740																																																		
▶ 2	5090	3476	00:02:00	20	0	0	11740																																																		
3																																																									
4																																																									
5																																																									

<table border="1"> <thead> <tr> <th>No</th> <th>SPEED</th> <th></th> <th>C</th> <th>DEC</th> <th>ROT</th> </tr> </thead> <tbody> <tr> <td>0</td> <td>4590</td> <td>LOAD</td> <td>0</td> <td>0</td> <td>11740</td> </tr> <tr> <td>1</td> <td>4590</td> <td>SAVE</td> <td>0</td> <td>0</td> <td>11740</td> </tr> <tr> <td>▶ 2</td> <td>5090</td> <td>DELETE</td> <td>0</td> <td>0</td> <td>11740</td> </tr> <tr> <td>3</td> <td></td> <td>CURVES</td> <td>0</td> <td>0</td> <td>11740</td> </tr> <tr> <td>4</td> <td></td> <td>-----</td> <td></td> <td></td> <td></td> </tr> <tr> <td>5</td> <td></td> <td>NEW PROGRAM</td> <td></td> <td></td> <td></td> </tr> </tbody> </table>	No	SPEED		C	DEC	ROT	0	4590	LOAD	0	0	11740	1	4590	SAVE	0	0	11740	▶ 2	5090	DELETE	0	0	11740	3		CURVES	0	0	11740	4		-----				5		NEW PROGRAM				<p><b>LOAD, SAVE, DELETE, NEW PROGRAM</b> refers chosen program which is marked by ▶.</p> <p>▶ - program currently selected</p>
No	SPEED		C	DEC	ROT																																						
0	4590	LOAD	0	0	11740																																						
1	4590	SAVE	0	0	11740																																						
▶ 2	5090	DELETE	0	0	11740																																						
3		CURVES	0	0	11740																																						
4		-----																																									
5		NEW PROGRAM																																									

<table border="1"> <thead> <tr> <th>No</th> <th>SPEED</th> <th></th> <th>C</th> <th>DEC</th> <th>ROT</th> </tr> </thead> <tbody> <tr> <td>0</td> <td>4590</td> <td>SAVE ?</td> <td>0</td> <td>0</td> <td>11740</td> </tr> <tr> <td>1</td> <td>4590</td> <td>-----</td> <td>0</td> <td>0</td> <td>11740</td> </tr> <tr> <td>▶ 2</td> <td>5090</td> <td>YES</td> <td>0</td> <td>0</td> <td>11740</td> </tr> <tr> <td>3</td> <td></td> <td>NO</td> <td>0</td> <td>0</td> <td>11740</td> </tr> <tr> <td>4</td> <td></td> <td>-----</td> <td></td> <td></td> <td></td> </tr> <tr> <td>5</td> <td></td> <td></td> <td></td> <td></td> <td></td> </tr> </tbody> </table>	No	SPEED		C	DEC	ROT	0	4590	SAVE ?	0	0	11740	1	4590	-----	0	0	11740	▶ 2	5090	YES	0	0	11740	3		NO	0	0	11740	4		-----				5						<p><b>LOAD</b> - loading the selected program</p> <p><b>SAVE</b> – save settings as a program (confirm by selecting <b>YES</b> and pressing <b>SET</b>)</p>
No	SPEED		C	DEC	ROT																																						
0	4590	SAVE ?	0	0	11740																																						
1	4590	-----	0	0	11740																																						
▶ 2	5090	YES	0	0	11740																																						
3		NO	0	0	11740																																						
4		-----																																									
5																																											

<table border="1"> <thead> <tr> <th>No</th> <th>SPEED</th> <th></th> <th>C</th> <th>DEC</th> <th>ROT</th> </tr> </thead> <tbody> <tr> <td>0</td> <td>4590</td> <td>DELETE ?</td> <td>0</td> <td>0</td> <td>11740</td> </tr> <tr> <td>1</td> <td>4590</td> <td>-----</td> <td>0</td> <td>0</td> <td>11740</td> </tr> <tr> <td>▶ 2</td> <td>5090</td> <td>YES</td> <td>0</td> <td>0</td> <td>11740</td> </tr> <tr> <td>3</td> <td></td> <td>NO</td> <td>0</td> <td>0</td> <td>11740</td> </tr> <tr> <td>4</td> <td></td> <td>-----</td> <td></td> <td></td> <td></td> </tr> <tr> <td>5</td> <td></td> <td></td> <td></td> <td></td> <td></td> </tr> </tbody> </table>	No	SPEED		C	DEC	ROT	0	4590	DELETE ?	0	0	11740	1	4590	-----	0	0	11740	▶ 2	5090	YES	0	0	11740	3		NO	0	0	11740	4		-----				5						<p><b>DELETE</b> – delete program (confirm by selecting <b>YES</b> and pressing <b>SET</b>)</p>
No	SPEED		C	DEC	ROT																																						
0	4590	DELETE ?	0	0	11740																																						
1	4590	-----	0	0	11740																																						
▶ 2	5090	YES	0	0	11740																																						
3		NO	0	0	11740																																						
4		-----																																									
5																																											

<table border="1"> <thead> <tr> <th>No</th> <th>SPEED</th> <th></th> <th>C</th> <th>DEC</th> <th>ROT</th> </tr> </thead> <tbody> <tr> <td>0</td> <td>4590</td> <td>LOAD</td> <td>0</td> <td>0</td> <td>11740</td> </tr> <tr> <td>1</td> <td>4590</td> <td>SAVE</td> <td>0</td> <td>0</td> <td>11740</td> </tr> <tr> <td>▶ 2</td> <td>5090</td> <td>DELETE</td> <td>0</td> <td>0</td> <td>11740</td> </tr> <tr> <td>3</td> <td></td> <td>CURVES</td> <td>0</td> <td>0</td> <td>11740</td> </tr> <tr> <td>4</td> <td></td> <td>-----</td> <td></td> <td></td> <td></td> </tr> <tr> <td>5</td> <td></td> <td>NEW PROGRAM</td> <td></td> <td></td> <td></td> </tr> </tbody> </table>	No	SPEED		C	DEC	ROT	0	4590	LOAD	0	0	11740	1	4590	SAVE	0	0	11740	▶ 2	5090	DELETE	0	0	11740	3		CURVES	0	0	11740	4		-----				5		NEW PROGRAM				<p><b>NEW PROGRAM</b>– enter to create new program mode (as below)</p>
No	SPEED		C	DEC	ROT																																						
0	4590	LOAD	0	0	11740																																						
1	4590	SAVE	0	0	11740																																						
▶ 2	5090	DELETE	0	0	11740																																						
3		CURVES	0	0	11740																																						
4		-----																																									
5		NEW PROGRAM																																									

**Creating a new program:**

	<ul style="list-style-type: none"> <li>Press <b>SET</b> key.</li> <li>Via ▲ ▼ ◀ ▶ keys mark <b>PROG</b> field (blinking).</li> </ul>
--	--



	<ul style="list-style-type: none"> <li>Press <b>SET</b> key. List of programs is visible, choose demanded position (number of program).</li> <li>Press <b>SET</b> key- menu of program settings will appear.</li> <li>Choose <b>NEW PROGRAM</b> press <b>SET</b> and <b>BACK</b>, and then set demanded parameters of centrifuging (look chapter <b>Centrifuging</b>).</li> <li>In case you want to register new program, back to the <b>PROG</b> menu and save it as described before.</li> </ul>

### Changing parameters during centrifuging

There is a possibility to change parameters: **SPEED, RCF, TIME, TEMP** during centrifuging. Such modifications inactivate currently running program. When program was set, modification during run is represented by **PROG --** symbol (instead of the program number).

## 7.5 Creator of acceleration and deceleration curves

	PROG/CURVES
	<ul style="list-style-type: none"> <li>With <b>▲▼</b> keys choose saved program for which you intend to create the acceleration or deceleration characteristics (marked with symbol <b>▶</b>).</li> <li>Press <b>SET</b>.</li> <li>With <b>▲▼</b> keys choose <b>CURVES</b>.</li> <li>Press <b>SET</b> - the selection frame is displayed.</li> <li>With <b>▲▼</b> keys choose <b>ACCELERATION</b> to create acceleration characteristics or <b>DECELERATION</b> to create deceleration characteristics</li> <li>Confirm selection by pressing <b>SET</b>.</li> </ul>

### 7.5.1 Acceleration characteristic, Creation of episode 1

	<b>No</b>	section no. (max. 4)
	<b>TIME</b>	total acceleration time
	<b>SPEED</b>	final RPM
	<b>ACC</b>	characteristic's no. (10-19)
	<b>+</b>	adding a new section

		deleting last section
		editing sections
		exiting from characteristics wizard
		switching RPM/RCF

After entering the curve wizard, the symbol is highlighted. Pressing **SET** and selecting "NO" in response to the question "SAVE?" will return to the **PROG → CURVES** menu without making changes to the starting characteristics. To start editing the one-segment characteristics, select the icon with the **◀▶** keys and press the **SET** key.

		editing value (flashing means editing the given value)
	<ul style="list-style-type: none"> <li>Press <b>SET</b></li> <li>With <b>▲▼◀▶</b> choose time for section</li> <li>Press <b>SET</b></li> <li>It is not possible to edit the maximum speed value. To do this, more sections have to be created, but the last section will always have the maximum set speed and cannot be changed.</li> <li>Select  with <b>▼◀</b> buttons and press <b>SET</b> to finish editing characteristics.</li> </ul>	

### 7.5.2 Adding and editing sections - acceleration

To program next sections, select the icon with the **◀▶** buttons and press **SET**. A new section (sections) will appear with a time of 1 second and a speed equal to the maximum speed.

To start editing a newly added section (sections), select the icon with the **◀▶** buttons and press **SET**, and follow the instructions given below.

After entering the profile section editing menu, the time value of the first section will be highlighted (see the picture below).

	<p>The maximum speed value for the section cannot be higher than the maximum speed value for the characteristic (for the last section).</p>	
	<ul style="list-style-type: none"> <li>With <b>▲▼◀▶</b> highlight time or speed for desired section</li> <li>Press <b>SET</b></li> <li>With <b>▲▼◀▶</b> choose value</li> <li>Press <b>SET</b></li> <li>Repeat until setting all the sections</li> <li>To finish editing characteristic with <b>▲▼◀▶</b> choose  and press <b>SET</b>. Finishing edition can be also done by pressing <b>BACK</b> button</li> </ul>	

**Saving created characteristic**

No	TIME
1	0:00:11
2	0:00:01
3	0:00:01

- Select the icon with the buttons and press **SET**
- In the "Save?" window, use buttons to select YES to confirm saving the characteristic or NO, to exit without saving
- Press **SET**

### 7.5.3 Acceleration graph

An example of given parameters and a graph:

No	TIME	11000
1	0:00:31	2000
2	0:01:05	6000
3	0:01:26	7000
4	0:02:03	11000

After programming the time and / or speed values, the segment (all segments) is graphically displayed on the graph on the right side of the screen. The time value is on the horizontal axis of the user's starting characteristic, while the speed is on the vertical axis.

### 7.5.4 Deceleration characteristic – creating section 1

<p><b>SPEED or 4000 displayed (example):</b></p> <table border="1"> <thead> <tr> <th>No</th> <th>TIME</th> <th>SPEED</th> </tr> </thead> <tbody> <tr> <td>1</td> <td>0:00:05</td> <td>0</td> </tr> </tbody> </table>	No	TIME	SPEED	1	0:00:05	0	<b>NO</b>	section no. (max. 4)
	No	TIME	SPEED					
	1	0:00:05	0					
	<b>TIME</b>	total acceleration time						
	<b>SPEED</b>	final RPM						
	<b>DEC</b>	characteristic's no. (10-19)						
		adding a new section						
		deleting last section						
	editing sections							
	exiting from characteristics menu							
	switching RPM/RCF							

After entering the curve wizard, the symbol is highlighted. Pressing **SET** and selecting "NO" in response to the question "SAVE?" will return to the **PROG → CURVES** menu without making changes to the starting characteristics. To start editing the one-segment characteristics, select the icon with the keys and press the **SET** key.

<table border="1"> <thead> <tr> <th>No</th> <th>TIME</th> <th>SPEED</th> </tr> </thead> <tbody> <tr> <td>1</td> <td>0:00:05</td> <td>0</td> </tr> </tbody> </table>	No	TIME	SPEED	1	0:00:05	0		editing value (flashing means editing the given value)
	No	TIME	SPEED					
1	0:00:05	0						
<ul style="list-style-type: none"> <li>Press <b>SET</b></li> <li>With     choose time for section</li> <li>Press <b>SET</b></li> <li>To edit speed</li> <li>It is not possible to edit the minimum speed value. To do this, more legends must be created, but the last leg will always be "0".</li> </ul>								



	<ul style="list-style-type: none"> <li>Select  with <b>▼ ◀▶</b> buttons and press <b>SET</b> to finish editing characteristics</li> </ul>
--	--

**7.5.5 Adding and editing sections - deceleration**

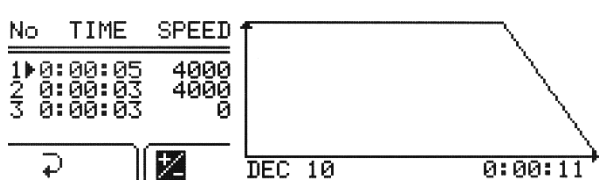

In order to program successive periods, select the icon  with the **◀▶** keys and press the **SET** key. A new segment (or segments - after successive presses of SET) will appear with the time and speed equal to the minimum speed - "0".

To start editing the newly added sections, select the icon  with the **◀▶** buttons, press **SET** and make the settings as described below.

After entering the profile section editing menu, the time value of the first section will be highlighted (see the picture below).

	<p>The speed value of the last segment will always be "0"</p> <ul style="list-style-type: none"> <li>With <b>▲▼◀▶</b> highlight time or speed for desired section</li> <li>Press <b>SET</b></li> <li>With <b>▲▼◀▶</b> choose value</li> <li>Press <b>SET</b></li> <li>Repeat until setting all the sections</li> <li>To finish editing characteristic with <b>▲▼◀▶</b> choose  and press <b>SET</b>. Finishing edition can be also done by pressing <b>BACK</b> button</li> </ul>
---	--

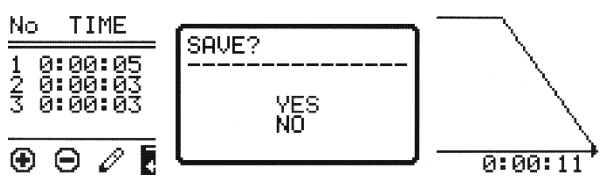
**Saving created characteristic**

	<ul style="list-style-type: none"> <li>Select the  icon with the <b>◀▶</b> buttons and press <b>SET</b></li> <li>In the "Save?" window, use <b>▲▼</b> buttons to select YES to confirm saving the characteristic or NO, to exit without saving</li> <li>Press <b>SET</b></li> </ul>
---	--

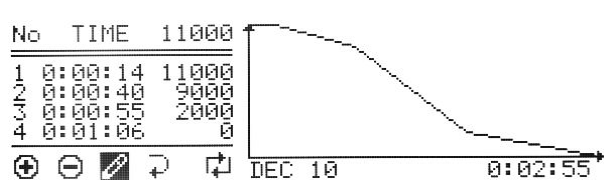

**7.5.6 Deceleration graph**

An example of given parameters and a graph:

	<p>After programming the time and / or speed values, the segment (all segments) is graphically displayed on the graph on the right side of the screen. The time value is on the horizontal axis of the user's braking characteristic, while the speed is on the vertical axis.</p>
---	--

**7.5.7 Deleting sections**

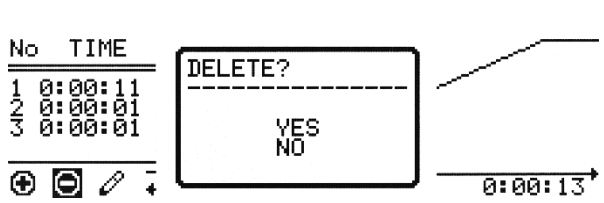
In the characteristic's wizard:

	<ul style="list-style-type: none"> <li>Select the  icon with the <b>◀▶</b> buttons and press <b>SET</b></li> <li>In the "Delete?" window, use <b>▲▼</b> buttons to select YES to confirm deleting the characteristic section or NO to cancel</li> <li>Press <b>SET</b></li> </ul>
---	---



## 7.6 Programs with user characteristics

Loading a modified program in the **CURVES** fold is signaled by the icon on the main screen:

	<p>Icon  signals that program with user acceleration/deceleration characteristics are loaded.</p>
--	--

A change in any parameter entails the deactivation of the multi-section's curves mode.

## 7.7 Rotor choosing



<p><b>Simplified display mode</b></p>																																																		
	<ul style="list-style-type: none"> <li>Press and hold  by 1 second.</li> <li>Choose rotor number (exemplary <b>11199/-----</b>) with <b>▲▼</b>.</li> <li>Press <b>SET</b>.</li> <li>Execute points described follow (below <b>Normal display mode</b> description)</li> </ul>																																																	
<p><b>Normal display mode</b></p>																																																		
<table border="1"> <thead> <tr> <th>NO</th> <th>ROTOR</th> <th>BUCKET</th> <th>SPEED</th> <th>RCF</th> <th>RMAX</th> <th>RMIN</th> </tr> </thead> <tbody> <tr> <td>1</td> <td>11199</td> <td>-----</td> <td>18000</td> <td>24270</td> <td>67</td> <td>35</td> </tr> <tr> <td>2</td> <td>11210</td> <td>-----</td> <td>5000</td> <td>3997</td> <td>143</td> <td>60</td> </tr> <tr> <td>3</td> <td>11211</td> <td>-----</td> <td>5500</td> <td>4498</td> <td>133</td> <td>87</td> </tr> <tr> <td>4</td> <td>11213</td> <td>-----</td> <td>5500</td> <td>4227</td> <td>125</td> <td>79</td> </tr> <tr> <td>5</td> <td>11259</td> <td>-----</td> <td>15000</td> <td>24400</td> <td>97</td> <td>65</td> </tr> <tr> <td>6</td> <td>11273</td> <td>-----</td> <td>12000</td> <td>14006</td> <td>87</td> <td>54</td> </tr> </tbody> </table>	NO	ROTOR	BUCKET	SPEED	RCF	RMAX	RMIN	1	11199	-----	18000	24270	67	35	2	11210	-----	5000	3997	143	60	3	11211	-----	5500	4498	133	87	4	11213	-----	5500	4227	125	79	5	11259	-----	15000	24400	97	65	6	11273	-----	12000	14006	87	54	<ul style="list-style-type: none"> <li>Press <b>SET</b>— appears.</li> <li>Via <b>▲▼◀▶</b> mark rotor choosing field.</li> <li>Press <b>SET</b> (Rotor list will appear).</li> <li>Via <b>▲▼</b> keys mark demanded rotor number</li> <li>Confirm by press <b>SET</b>.</li> <li>Press <b>BACK</b>.</li> </ul>
NO	ROTOR	BUCKET	SPEED	RCF	RMAX	RMIN																																												
1	11199	-----	18000	24270	67	35																																												
2	11210	-----	5000	3997	143	60																																												
3	11211	-----	5500	4498	133	87																																												
4	11213	-----	5500	4227	125	79																																												
5	11259	-----	15000	24400	97	65																																												
6	11273	-----	12000	14006	87	54																																												
<p>It is possible to set <b>AUTOMATIC ROTOR IDENTIFICATION</b>. The procedure is described in subsection <i>Others</i>.</p>																																																		

## 7.8 SHORT mode

	<ul style="list-style-type: none"> <li>The <b>SHORT</b> mode is activated by pressing and holding <b>▶▶(SHORT)</b>.</li> </ul> <p>In <b>SHORT</b> mode the centrifuge is working as long as the <b>SHORT</b> key is pressed or when set time is over.</p>
--	---

## 7.9 Finishing the centrifuging

	<p>When preselected time is reached, centrifugation will end automatically.</p>

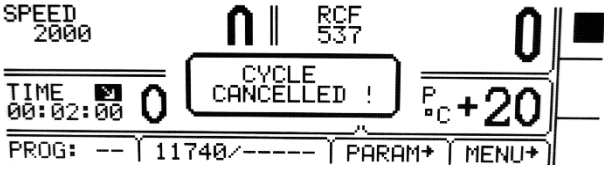
 x1	<ul style="list-style-type: none"> <li>Before lapse preselected time one may stop centrifugation. Pressing <b>STOP</b> for the first time will stop centrifuging with the characteristic set in loaded program. ↓ symbol will be shown.</li> </ul>
 x2	<ul style="list-style-type: none"> <li>Pressing <b>STOP</b> second time will stop centrifuging with the fastest characteristic. ↓ symbol will be shown.</li> </ul>
	
<ul style="list-style-type: none"> <li>The message about cancel of centrifuging can be delete with the <b>STOP, SET, COVER, ▲▼◀▶</b> or <b>BACK</b> key.</li> </ul>	

### 7.10 Temporarily disabled functions

Functions written below can be temporarily disabled.

	SPEED	RCF	TIME	TEMP	PROG —	— / — —	PARAM	MENU
THERMAL CHAMBER	●	●	●	○	●	●	●	●
STANDARD CENTRIFUGING	●	●	●	●	●	○	●	○



- available
- disabled



## 8. Temperature control

	<b>MPW-380R</b> only
---	----------------------

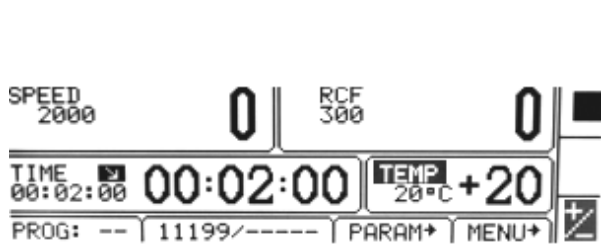
Centrifuge is equipped with ecological refrigerating system with temperature control. During centrifugation, there may appear differences in temperature on the display and temperature of the samples in the rotor. It depends on thermal conductivity of the rotor, and samples and centrifugation time, initial temperature of rotor and samples.

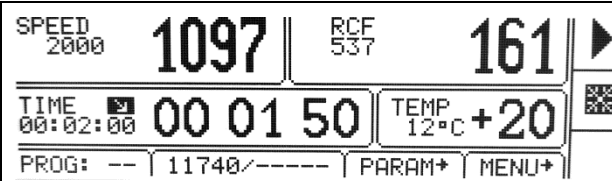

Exemplary change of **TEMP** setting:

	<ul style="list-style-type: none"> <li>Press <b>SET</b> (to enter edit mode)  – appears.</li> <li>Via <b>▲▼◀▶</b> keys mark <b>TEMP</b> field (blinking).</li> <li>Press <b>SET</b> key.</li> <li>With <b>▲▼</b> choose demanded value (from -20°C to 40°C).</li> <li>Confirm settings by pressing <b>SET</b>.</li> <li>Press <b>BACK</b>.</li> </ul>
---	--

	<p>Cooling is indicated by a symbol  (blinking).</p>
---	---

### 8.1 Initial cooling during centrifuging –FAST COOL

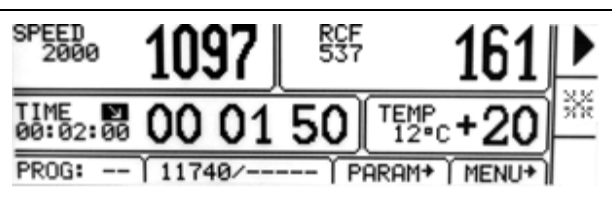
	<p>The parameters allowable to change at <b>FAST COOL</b> mode:</p> <ul style="list-style-type: none"> <li>temperature (lower than current temperature shown by centrifuge)</li> </ul> <ul style="list-style-type: none"> <li>In order to centrifuging reduced temperature samples (e.g. storage in the external refrigerator) centrifuge chamber, rotor and centrifuge container must be pre-cooling to the predetermined temperature. It causes minimalization of temperature differences.</li> <li>Initial cooling may be activated by <b>FAST COOL</b> key (lid must be closed – rotor is spinning at <b>FAST COOL</b> mode)</li> <li>When <b>FAST COOL</b> mode is active, cooling system automatically set proper parameters to obtain demanded temperature the fastest way.</li> </ul>
---	---

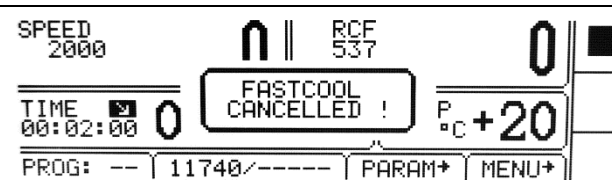
	<p><b>FAST COOL</b> mode is marked by symbol  blinking in the right upper side of display.</p>
	<p>It is possible to exit <b>FAST COOL</b> mode at any time by pressing <b>STOP</b> key. Interruption of the function is signaled by a message.</p>

### 8.2 Initial cooling or heating without centrifuging – THERMAL CHAMBER

	PARAM → <b>THERMAL CHAMBER</b>
	<ul style="list-style-type: none"> <li>There is possible to run centrifuge in <b>THERMAL CHAMBER</b> mode - cooling for R (rotor is at standstill).</li> <li>How to enable <b>THERMAL CHAMBER</b> is described in Parameters of centrifugation chapter.</li> </ul>

### 8.3 Cooling or heating in “START DELAY – OF TEMPERATURE” mode

	PARAM → <b>START DELAY – OF TEMPERATURE</b>
	<ul style="list-style-type: none"> <li>Centrifuging process will start, when preselected temperature is reached.</li> <li>How to enable run <b>START DELAY – OF TEMPERATURE</b> function is described in Parameters of centrifugation chapter.</li> </ul>



### 8.4 Cooling or heating in „SHORT” mode

	<ul style="list-style-type: none"> <li>Cooling and heating features are available in <b>SHORT</b> mode.</li> <li>How to enable run centrifugation in <b>SHORT mode</b> is described in <i>Centrifugation/SHORT mode</i>.</li> </ul>
---	---

## 8.5 Cooling and heating notes

Centrifuges with cooling (MPW-380R) are equipped with an efficient cooling system. It allows obtaining selected temperatures in the chamber even at maximum spin speed or fast obtaining desired temperatures (e.g., 4°C and 36°C). Note that time and possibility of obtaining a set temperature is dependent on multiple factors, including: the power of the cooling system, the shape of the rotor, the rotor speed, ambient temperature, etc. The accuracy of the temperature stability of  $\pm 1^\circ\text{C}$  is determined by the installation place of the temperature sensor.

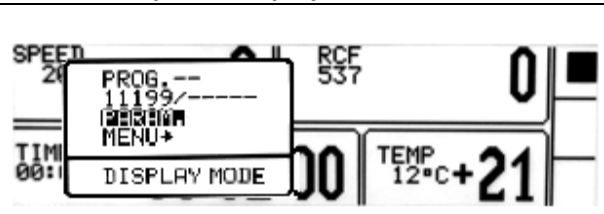
## 9. Parameters of centrifugation

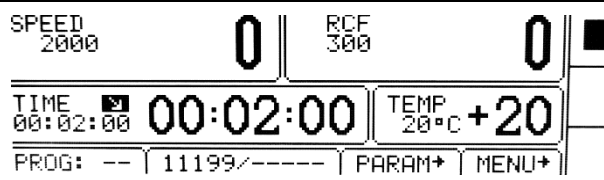
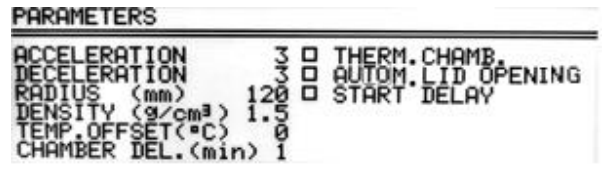
Simplified display	
	<ul style="list-style-type: none"> <li>Press and hold  by 1 second.</li> <li>Choose <b>PARAM.</b> with <math>\blacktriangle</math> <math>\blacktriangledown</math></li> <li>Press <b>SET.</b></li> </ul> <p>Execute points described follow (below <b>Normal display mode</b> description)</p>
Normal display	
	<ul style="list-style-type: none"> <li>Press <b>SET.</b></li> <li>With <math>\blacktriangle</math> <math>\blacktriangledown</math> <math>\blacktriangleleft</math> <math>\blacktriangleright</math> keys select <b>PARAM.</b></li> <li>Press <b>SET.</b></li> </ul>
	

<b>ACCELERATION</b>	chosen acc. characteristic (0-the fastest, 9-the slowest)
<b>DECELERATION</b>	chosen dec. characteristic (0-the fastest, 9-the slowest)
<b>RADIUS [mm]</b>	current rotor radius [mm]
<b>DENSITY (g/cm<sup>3</sup>)</b>	sample density [g/cm <sup>3</sup> ]
<b>TEMP. OFFSET (°C)</b>	value of temperature correction
<b>CHAMBER DEL. (min)</b>	delay between set thermal chamber mode and start it
<b>THERMAL CHAMBER</b>	cooling of the chamber without centrifuging
<b>AUTOM. LID OPENING</b>	opening cover after centrifuging automatically
<b>START DELAY</b>	starting delayed (after pressing START)

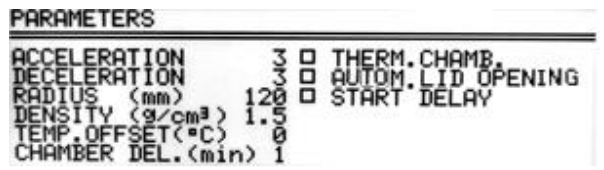

### 9.1 Acceleration/deceleration – changing characteristic.

	<ul style="list-style-type: none"> <li>With <math>\blacktriangle</math> <math>\blacktriangledown</math> keys select <b>ACCELERATION</b> or <b>DECELERATION.</b></li> <li>Press <b>SET.</b></li> <li>With <math>\blacktriangle</math> <math>\blacktriangledown</math> keys select demanded number of characteristics.</li> <li>Press <b>SET.</b></li> </ul> <p><b>ACCELERATION</b> –10 (0 ÷ 9), linear accelerating characteristics assigned to every rotor. 0-the fastest acceleration, 9-the slowest acceleration.</p>
---	---



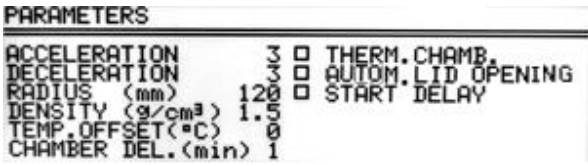

	<b>DECELERATION</b> – 10 (0 ÷ 9), linear decelerating characteristics assigned to every rotor. 0-the fastest deceleration, 9-the slowest deceleration.
--	--

## 9.2 Radius

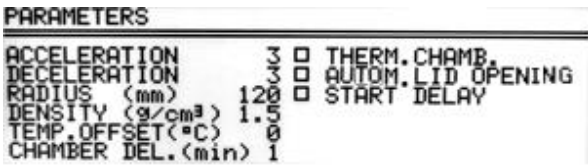

 <pre> PARAMETERS ----- ACCELERATION      3  □ THERM. CHAMB. DECELERATION      3  □ AUTOM. LID OPENING RADIUS (mm)       120 □ START DELAY DENSITY (g/cm³)   1.5 TEMP. OFFSET(°C)  0 CHAMBER DEL.(min) 1 </pre>	<p><b>RADIUS [mm]</b> - control of the radius of the rotor within the range from <math>R_{min}</math> to <math>R_{max}</math>. Available values depends on chosen rotor. Radius correction serve for more precise control RCF, exemplary when user need to know real RCF in half length of test tube.</p> <p>To change the rotor radius:</p> <ul style="list-style-type: none"> <li>▪ select <b>RADIUS [mm]</b> with ▲▼ keys.</li> <li>▪ Press <b>SET</b>.</li> <li>▪ Set demanded value by pressing ▲▼.</li> <li>▪ Press <b>SET</b>.</li> </ul>
 <pre> SPEED 2000  0  RCF 496  0 TIME 00:02:00 00:02:00 TEMP 12°C +20 PROG: -- 11740/----- PARAM+ MENU+ </pre>	<p>When radius correction is activated,  symbol is visible on the screen.</p> <p>Reducing of the rotor radius resulting change of displayed RCF value.</p>

## 9.3 Sample density

 <pre> PARAMETERS ----- ACCELERATION      3  □ THERM. CHAMB. DECELERATION      3  □ AUTOM. LID OPENING RADIUS (mm)       120 □ START DELAY DENSITY (g/cm³)   1.5 TEMP. OFFSET(°C)  0 CHAMBER DEL.(min) 1 </pre>	<p><b>DENSITY (g/cm<sup>3</sup>)</b> – default density is set to <b>1,2 g/cm<sup>3</sup></b></p> <p>To change the density (possible values <b>1,2÷9,9 g/cm<sup>3</sup></b>):</p> <ul style="list-style-type: none"> <li>▪ Via ▲▼ keys select <b>DENSITY (g/cm<sup>3</sup>)</b></li> <li>▪ Press <b>SET</b>.</li> <li>▪ Set demanded value by pressing ▲▼.</li> <li>▪ Press <b>SET</b>.</li> </ul>
 <pre> SPEED 2000  0  RCF 300  0 TIME 00:02:00 00:02:00 TEMP 20°C +20 PROG: -- 11199/----- PARAM+ MENU+ </pre>	<p>When density is changed,  symbol is visible on the screen.</p> <p>Changing of <b>DENSITY</b> value is obligatory when density of sample placed into rotor is higher than 1.2 g/cm<sup>3</sup>.</p> <p><b>Change of DENSITY value led to decreasing maximum value of accessible speed.</b></p>



## 9.4 Temperature offset

	<p>MPW-352R only</p>	
		<p>Temperature offset serve for more precise control of real sample temperature. It can be helpful in case high/low initial temperature samples or high volume samples.</p> <ul style="list-style-type: none"> <li>▪ With ▲▼ keys select <b>TEMP. OFFSET</b>.</li> <li>▪ Press <b>SET</b>.</li> </ul>

<pre> PARAMETERS ----- ACCELERATION      3  <input type="checkbox"/> THERM. CHAMB. DECELERATION      3  <input type="checkbox"/> AUTOM. LID OPENING RADIUS (mm)      120 <input type="checkbox"/> START DELAY DENSITY (g/cm³)  1.5 TEMP. OFFSET(°C)  0 CHAMBER DEL.(min) 1 </pre>	<ul style="list-style-type: none"> <li>Use the ▲ ▼ keys to select the difference between the temperature that the cooling system will aim for, and set temperature. Confirm selection by pressing <b>SET</b>.</li> </ul> <p><b>Attention!</b> The use of the offset can not extend the temperature range achieved by the centrifuge.</p> <p><b>Function description</b> At a set temperature of 20°C and the set offset value equal to -5°C, cooling system will actually strive to reach 15°C. With a setpoint temperature of 20°C and a set offset value of 5°C the system will actually try to reach 25°C.</p> <p>The temperature displayed on the main screen is corrected for offset value.</p> <p>Offset can be selected range from -20°C to 20°C.</p>
	<p>Activation of the function is signaled on the main screen with  or  depending on the offset value sign.</p>

## 9.5 Thermal chamber

	<p>MPW-380R only</p>
---	----------------------

<p>Cooling without centrifuging.</p>	<p style="text-align: right;"><b>THERMAL CHAMBER</b></p>
<pre> PARAMETERS ----- ACCELERATION      3  <input type="checkbox"/> THERM. CHAMB. DECELERATION      3  <input type="checkbox"/> AUTOM. LID OPENING RADIUS (mm)      120 <input type="checkbox"/> START DELAY DENSITY (g/cm³)  1.5 TEMP. OFFSET(°C)  0 CHAMBER DEL.(min) 1 </pre>	<ul style="list-style-type: none"> <li>With ▲▼◀▶ keys select <b>THERMAL CHAMBER</b>.</li> <li>Press <b>SET</b> (to turn on/off).</li> <li>With ▲ ▼ keys select temperature value.</li> <li>Set demanded value (0°C÷40°C) by pressing ▲ ▼. Confirm selection by pressing <b>SET</b>.</li> <li>Attention, do not set the thermal chamber to a value higher than currently indicated by the centrifuge.</li> </ul>
	<ul style="list-style-type: none"> <li>When THERMAL CHAMBER function is activated,  symbol is visible on the screen.</li> <li>Changing temperature from the main screen is not possible.</li> <li>Opening cover terminates THERMAL CHAMBER function (closing cover back turns it on).</li> </ul>
<pre> PARAMETERS ----- ACCELERATION      3  <input type="checkbox"/> THERM. CHAMB. DECELERATION      3  <input type="checkbox"/> AUTOM. LID OPENING RADIUS (mm)      120 <input type="checkbox"/> START DELAY DENSITY (g/cm³)  1.5 TEMP. OFFSET(°C)  0 CHAMBER DEL.(min) 1 </pre>	<p>Thermal chamber is activated with delay. Set time of delaying by select <b>CHAMBER DEL.</b></p> <ul style="list-style-type: none"> <li>Press <b>SET</b>.</li> <li>With ▲ ▼ keys select demanded value (1-5 min).</li> <li>Press <b>SET</b>.</li> </ul>

- The function is activated automatically after confirmation and with the lid closed. When the lid is opened, the function is interrupted, and when the lid is closed again, the function resumes. If the **THERMAL CHAMBER** function is enabled during the centrifugation cycle, at the end of this cycle, the **THERMAL CHAMBER** function is activated until the lid is opened.
- Contrary to other parameters, the **THERMAL CHAMBER** function can be turned on only when the centrifuge is stopped.

## 9.6 Automatic lid opening



Automatic lid opening	<b>AUTOMATIC LID OPENING</b>
	<ul style="list-style-type: none"> <li>▪ When centrifuge process is finished, cover will be opened automatically for set option AUTOM. LID OPENING.</li> <li>▪ When centrifuging is terminated by pressing <b>STOP</b>, opening cover is possible by pressing <b>COVER</b>.</li> </ul>
	<ul style="list-style-type: none"> <li>▪  symbol means that OPEN LID AFTER RUN is active.</li> </ul>

## 9.7 Start delay - of time

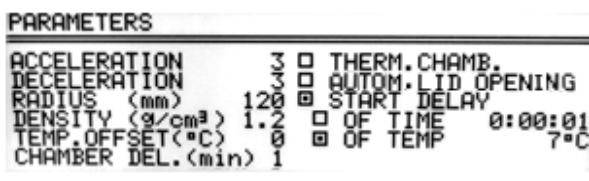

	Start centrifuging since reselected delay is reached.	<b>START DELAY / OF TIME</b>
	<ul style="list-style-type: none"> <li>▪ With <b>▲▼</b> keys select <b>START DELAY</b>. Press <b>SET</b>.</li> <li>▪ Start delay can be set from 0 : 0 0 : 0 1 to 9 : 5 9.</li> <li>▪ With <b>▲▼</b> keys select OF TIME. Press <b>SET</b> and <b>▶</b> and then <b>SET</b>.</li> <li>▪ With <b>▲▼</b> keys set demanded value.</li> <li>▪ Confirm by pressing <b>SET</b>.</li> <li>▪ Press <b>BACK</b> to escape edit mode.</li> </ul>	
	When <b>START DELAY</b> function is activated,  symbol is visible on the screen.	
START DELAY / OF TIME function cannot be run when START DELAY / OF TEMP is activated.		

## 9.8 Start delay – of temperature

	<b>MPW-380R only</b>	
	Start centrifuging time counting since preselected temperature is reached.	<b>START DELAY / OF TEMP.</b>

	<ul style="list-style-type: none"> <li>With ▲▼◀▶ keys mark <b>START DELAY</b>.</li> <li>Press <b>SET</b>.</li> <li>With ▲▼◀▶ keys mark <b>OF TEMP</b>.</li> <li>Press <b>SET</b>.</li> <li>Press ▶, press <b>SET</b>.</li> <li>With ▲▼ keys set demanded value of temperature.</li> <li>Press <b>SET</b>.</li> <li>Exit edit mode by press <b>BACK</b>.</li> </ul>
	<p>When <b>START DELAY – OF TEMPERATURE</b> is turned on,  symbol is visible on the screen.</p>
<p>When the function is active, the speed can be reduced to the optimum values for the <b>FAST COOL</b> function, when the set speed is lower than the optimum value, the rotor rotates at the set by user speed.</p>	
<p><b>START DELAY / OF TEMP.</b> function cannot be run when <b>START DELAY / OF TIME</b> is activated.</p>	

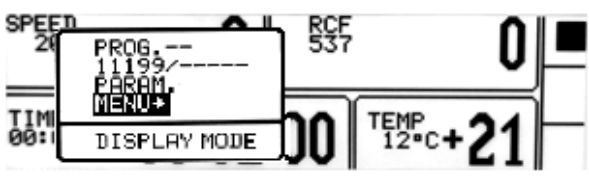
## 10. Menu

<b>Simplified display</b>									
	<ul style="list-style-type: none"> <li>Press and hold  by 1 second.</li> <li>Choose <b>MENU</b> with ▲▼</li> <li>Press <b>SET</b>.</li> </ul> <p>Execute points described follow (below <b>Normal display mode</b> description)</p>								
<b>Normal display</b>									
	<ul style="list-style-type: none"> <li>Press <b>SET</b>.</li> <li>With ▲▼◀▶ keys select <b>MENU</b>.</li> <li>Press <b>SET</b>.</li> </ul>								
<p style="text-align: center;">MENU</p> <hr/> <table border="0" style="width: 100%;"> <tr> <td>CONFIGURATION</td> <td>ROTOR RUNTIME</td> </tr> <tr> <td>PASSWORD</td> <td>CONTACT US</td> </tr> <tr> <td>LAST 10 CYCLES</td> <td>DIAGNOSTICS</td> </tr> <tr> <td>WORK TIME</td> <td>FACTORY SETTINGS</td> </tr> </table>	CONFIGURATION	ROTOR RUNTIME	PASSWORD	CONTACT US	LAST 10 CYCLES	DIAGNOSTICS	WORK TIME	FACTORY SETTINGS	<ul style="list-style-type: none"> <li>To navigate in <b>MENU</b> use ▲▼◀▶ keys.</li> <li>To enter menu press <b>SET</b>.</li> </ul>
CONFIGURATION	ROTOR RUNTIME								
PASSWORD	CONTACT US								
LAST 10 CYCLES	DIAGNOSTICS								
WORK TIME	FACTORY SETTINGS								

CONFIGURATION	centrifuge configuration
PASSWORD	password protection
LAST 10-CYCLES	10 last centrifugation cycles history
CYCLES	total working time of centrifuge, total number of working cycles counter
ROTOR RUNTIME	counting time of work and cycles amount for each rotor
CONTACT US	manufacturer's details
DIAGNOSTICS	error codes (service field)
FACTORY SETTINGS	restore factory settings

### 10.1 Screen saver

Setting time of screen saver	MENU/ CONFIGURATION / <b>SCREEN</b>
	<ul style="list-style-type: none"> <li>With ▲▼◀▶ keys select <b>SCREENSAVER</b>.</li> <li>Press <b>SET</b> and then ▼ and <b>SET</b>.</li> <li>With ▲▼ keys select demanded value from 1 to 60 minutes.</li> <li>Mark selection by pressing <b>SET</b>.</li> <li>Leave the menu by pressing <b>BACK</b>.</li> </ul>

### 10.2 Visual alarm

Visual alarm	MENU/CONFIGURATION/ <b>SCREEN</b>
	<ul style="list-style-type: none"> <li>Via ▲▼ keys choose <b>VISUAL ALARM</b></li> <li>Mark it by pressing <b>SET</b>.</li> </ul> <p><b>VISUAL ALARM</b> cause blinking screen after ending of centrifuging or after message occurring.</p>

### 10.3 Types of main screen

To ensure optimal adaptation to the user's preferences, work is possible in two basic screen modes.

**NORMAL DISPLAY** - contains an expanded number of parameters visible on the display.

**SIMPLIFIED DISPLAY** - contains only the most important parameters visible on the display.

For each of the above modes, you can choose priority RPM display or RCF.

By default, the **SIMPLIFIED DISPLAY** is set

Types of main screen	
<b>NORMAL DISPLAY</b>	<b>SIMPLIFIED DISPLAY</b>
Switch between the <b>SPEED</b> (RPM) and <b>RCF</b> display priority modes	
<ul style="list-style-type: none"> <li>In the <b>NORMAL DISPLAY</b> mode, selecting the <b>SPEED</b> or <b>RCF</b> display mode is obtained by pressing and holding <b>BACK</b> for 1 sec.</li> <li>then use the ▲ ▼ buttons to select the desired mode (<b>SPEED</b> or <b>RCF</b>) and press <b>SET</b>.</li> </ul>	<ul style="list-style-type: none"> <li>In the <b>SIMPLIFIED DISPLAY</b> mode, the selection of the <b>SPEED</b> or <b>RCF</b> display mode is obtained by pressing and holding the <b>BACK</b> key for 1 second.</li> <li>then use ▲ ▼ keys to select <b>DISPLAY MODE</b>, press <b>SET</b>, and then use ▲ ▼ keys to select the desired mode (<b>SPEED</b> or <b>RCF</b>) and press <b>SET</b>.</li> </ul>

### 10.3.1 Switching the normal display to simplified display

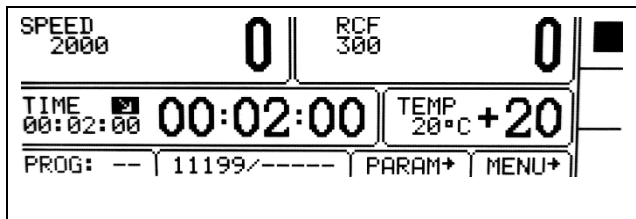
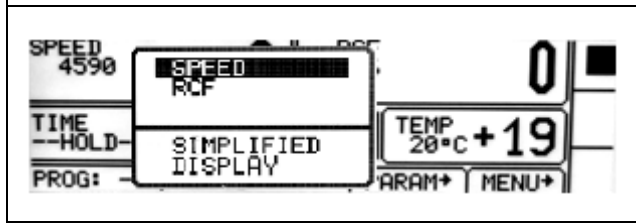
	<p>Press the <b>BACK</b> button for 1 sec. then:</p>
	<ul style="list-style-type: none"> <li>▪ Via ▲▼ keys select <b>SIMPLIFIED DISPLAY</b>. Press <b>SET</b>.</li> </ul>

### 10.3.2 Switching the simplified screen to normal display

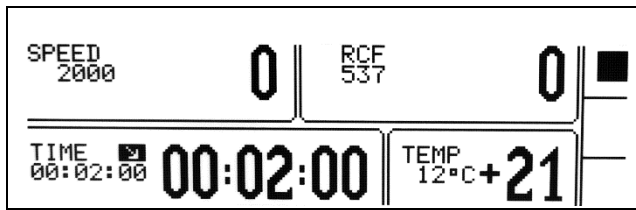
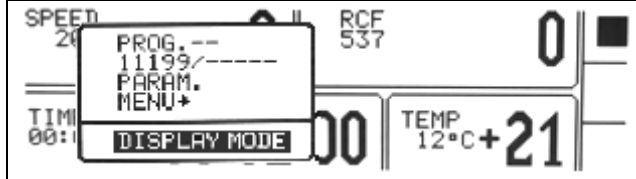
	<ul style="list-style-type: none"> <li>▪ Press the <b>BACK</b> button for 1 sec. then:</li> </ul>
	<ul style="list-style-type: none"> <li>▪ Via ▲▼ keys select <b>DISPLAY MODE</b> (blinking).</li> <li>▪ Press <b>SET</b>.</li> <li>▪ Then choose <b>NORMAL DISPLAY</b> and press <b>SET</b>.</li> </ul>

### 10.4 Rotating runtime

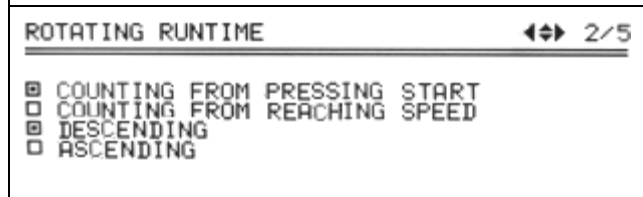
Way of time counting	MENU/CONFIGURATION/ <b>ROTATING RUNTIME</b>
	<ul style="list-style-type: none"> <li>▪ Via ▲▼ choose demanded option.</li> <li>▪ Mark it by pressing <b>SET</b>.</li> </ul>
<p><b>Counting from:</b></p> <p style="text-align: right;">Pressing start → COUNTING SINCE ROTOR IS IDENTIFIED</p> <p style="text-align: right;">Reaching speed → COUNTING FROM ASSIGNED SPEED</p>	
<p><b>Presenting mode:</b></p> <p style="text-align: right;">Descending → COUNTING DOWN</p> <p style="text-align: right;">Ascending → COUNTING UP</p>	

### 10.5 Buzzer

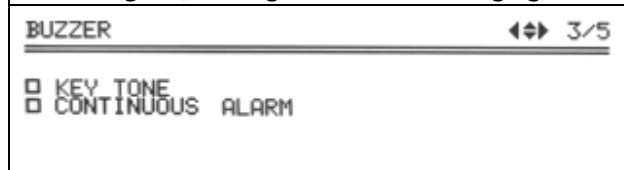
Switching ON/OFF short audible signals accompanying every pressing of any key. Switching ON/OFF signals after centrifuging.	MENU/ CONFIGURATION / <b>BUZZER</b>
	<ul style="list-style-type: none"> <li>▪ With ▲▼ keys select demanded option.</li> <li>▪ Mark selection by pressing <b>SET</b>.</li> </ul>

	A continuous alarm means the emission of short beeps after the end of the spin, until the message about the end of the work cycle is deleted.
<b>Warning signals are always switched on.</b>	

## 10.6 Language

Changing menu language	MENU / CONFIGURATION / <b>LANGUAGE</b>
	<ul style="list-style-type: none"> <li>Via ▲▼ keys choose demanded menu language</li> <li>Mark it by pressing <b>SET</b>.</li> </ul>

## 10.7 Other

<b>Rotor automatic identification</b>	MENU / CONFIGURATION / <b>OTHER</b>
	<p>Thanks to the automatic rotor identification, the centrifuge automatically identifies the rotor in the chamber. Rotor identification is indicated by the message.</p> <p>When the function is deactivated, it is necessary to manually select the desired rotor as described in <b>Rotor choosing</b>.</p> <p>The <b>AUTOMATIC IDENTIF.</b> is turned on by default.</p> <p>To enable the function:</p> <ul style="list-style-type: none"> <li>Via ▲▼ keys choose</li> <li><input type="checkbox"/> <b>AUTOMATIC IDENTIF.</b></li> <li>Press <b>SET</b> (<input type="checkbox"/> change to <input checked="" type="checkbox"/> or conversely).</li> </ul> <p>Autoidentification is not active for work in the loaded program mode.</p>

<b>Choice of temperature unit</b>	MENU / CONFIGURATION / <b>OTHER</b>
	<p>The <b>TEMPERATURE</b> in °C is turned on by default.</p> <p>To change the temperature unit:</p> <ul style="list-style-type: none"> <li>Via ▲▼ keys select unit</li> <li>Confirm by pressing <b>SET</b>.</li> </ul>

<b>TEMPERATURE IN °C</b>	<b>TEMPERATURE IN °F</b>



## 10.8 Password

Setting up password	MENU / PASSWORD
<p>To prevent from an unauthorized use, a <b>PASSWORD</b> can be set.</p> <p><b>Note:</b> No PASSWORD is set by default.</p> <p>The PASSWORD can be set as follows when the rotor is at a standstill.</p>	
<pre> PASSWORD      LOCK: ----- PASSWORD:    <input type="checkbox"/> SAVE PROGRAM               <input type="checkbox"/> DELETE PROGRAM               <input type="checkbox"/> CHANGE PARAMETERS               <input type="checkbox"/> LOAD PROGRAM               <input type="checkbox"/> START KEY 1234           </pre>	<ul style="list-style-type: none"> <li>▪ With ▲ ▼ keys select the <b>PASSWORD</b> field (is blinking), press SET.</li> <li>▪ With the ▲ ▼ keys select the appropriate digit in the first field, e.g., <b>1xxx</b>.</li> <li>▪ Press ►</li> <li>▪ With the ▲ ▼ keys select the appropriate digit in the second field, e.g., <b>12xx</b>.</li> <li>▪ Press ►</li> <li>▪ Use the ▲ ▼ keys to select the appropriate digit in the third field, e.g., <b>123x</b>.</li> <li>▪ Press ►</li> <li>▪ Use the ▲ ▼ keys to select the correct digit in the fourth field, e.g., <b>1234</b>.</li> <li>▪ Press SET.</li> </ul>
<pre> PASSWORD      LOCK: ----- CONFIRM:     <input type="checkbox"/> SAVE PROGRAM               <input type="checkbox"/> DELETE PROGRAM               <input type="checkbox"/> CHANGE PARAMETERS               <input type="checkbox"/> LOAD PROGRAM               <input type="checkbox"/> START KEY 1234           </pre>	<ul style="list-style-type: none"> <li>▪ As a confirmation repeat instructions described above.</li> </ul>
<p>When the <b>PASSWORD</b> is set, the Key sign is displayed in the <b>CODE</b> zone. It is also displayed in the main menu (lower right corner of the screen).</p>	
<pre> PASSWORD      LOCK: -----               <input type="checkbox"/> SAVE PROGRAM               <input type="checkbox"/> DELETE PROGRAM               <input type="checkbox"/> CHANGE PARAMETERS               <input type="checkbox"/> LOAD PROGRAM               <input type="checkbox"/> START KEY ****           </pre>	
<p>From then on, access to the <b>MENU</b> is possible after entering the password.</p> <p>In case of incorrect password, it will show message: <b>ACCESS DENIED!</b></p>	
<p>The removal of an active password is possible after setting the password "0000" (after entering the currently set password). If the password is forgotten, it is possible to use the emergency password "7654", which removes the previous password and all locks. Using both methods will delete the previous password and disable all security features.</p>	

Setting up locks	
<pre> PASSWORD      LOCK: -----               <input type="checkbox"/> SAVE PROGRAM               <input type="checkbox"/> DELETE PROGRAM               <input type="checkbox"/> CHANGE PARAMETERS               <input type="checkbox"/> LOAD PROGRAM               <input type="checkbox"/> START KEY ****           </pre>	<ul style="list-style-type: none"> <li>▪ With ▲ ▼ keys choose a lock.</li> <li>▪ Mark a lock by pressing <b>SET</b>.</li> <li>▪ Repeat above steps for desired locks.</li> <li>▪ Leave menu with <b>BACK</b> key.</li> </ul>

Disabled*	description
-----------	-------------

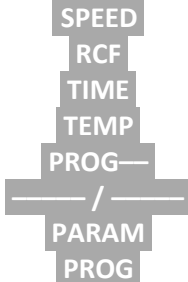

<b>SAVE PROGRAM</b>	<b>SAVE</b> button	<ul style="list-style-type: none"> <li>no programs can be saved</li> </ul>
<b>DELETE PROGRAM</b>	<b>DELETE</b> button	<ul style="list-style-type: none"> <li>no programs can be deleted</li> <li>saving programs on position where one was already stored is disabled</li> </ul>
<b>CHANGE PARAMETERS</b>	fields: 	<ul style="list-style-type: none"> <li>parameters can not be modified</li> </ul>
<b>LOAD PROGRAM</b>	<b>LOAD</b> button	<ul style="list-style-type: none"> <li>no programs can be called up</li> </ul>
<b>START KEY</b>	<b>START</b> key	<ul style="list-style-type: none"> <li>centrifugation can not be started</li> </ul>

\* Executing disabled procedures is only possible after entering the correct

### 10.9 Last 10 cycles

Information concerning parameters of last 10 centrifuging cycles.	<b>MENU / LAST 10 CYCLES</b>
<pre> NO CYCLES: 05 ----- DATE/TIME: -- PROGRAM: -- ROTOR/BUCKET: 11740/----- SPEED: 2000 RCF: 537 TIME: 00:02:00           </pre>	<ul style="list-style-type: none"> <li>Number of cycle can be changed by ◀▶ keys.</li> <li>The list can be scrolled using ▲▼ keys.</li> <li>To exit press <b>SET/BACK</b> key</li> </ul>

### 10.10 Work time

Total working time of centrifuge, and quantity of working cycles.	<b>MENU / WORK TIME</b>
<pre> WORK TIME ----- TOTAL RUN TIME: 0h 13m 14s CYCLES: 31           </pre>	<ul style="list-style-type: none"> <li>In the <b>WORK TIME</b> menu the following statistics are displayed: <ul style="list-style-type: none"> <li>total working (centrifugation) time</li> <li>working cycles counter</li> </ul> </li> </ul>

### 10.11 Rotor runtime

Information about the time of centrifuging and of the quantity of the working cycles of each rotor. The table also contains icons warning of the duty of execution of validation.	<b>MENU / ROTOR RUNTIME</b>
<pre> No S  ROTOR BUCKET CYCLES  NOM.C  TIME ----- 1 ✓   11199  -----   1  15000   0 2 ✓   11210  -----   0  15000   0 3 ✓   11211  -----   0  15000   0 4 ✓   11213  -----   0  15000   0 5 ✓   11259  -----   0  15000   0 6 ✓   11273  -----   0  15000   0           </pre>	<ul style="list-style-type: none"> <li>The list can be scrolled using ▲▼ keys.</li> <li>To exit press <b>BACK</b> key.</li> </ul> Symbols: <ul style="list-style-type: none"> <li>✓ – more than 100 cycles left</li> <li>! – less than 100 cycles left</li> <li>! – worn rotor</li> </ul>

## 10.12 Contact us

Information about the type of the centrifuge, firmware version, and contact details.	MENU / CONTACT US
<pre>CONTACT US      MPW-380R      07.9.16 MPW MED. INSTRUMENTS 04-347 WARSAW 46 BOREMLOWSKA STREET WWW.MPW.PL , MPW@MPW.PL SALES DEPARTMENT:</pre>	The list can be scrolled using ▲▼ keys. To exit press <b>BACK</b> key.

## 10.13 Diagnostics

Information about errors arisen in working of the centrifuge (for service).	MENU / DIAGNOSTICS
<pre>No      DATE      TIME      ERROR ----- 20000404  --      --      200</pre>	Information on error numbers that occurred during the operation of the centrifuge  <b>Intended for service purposes!</b>

## 10.14 Factory settings

Restoring factory settings.	MENU/ FACTORY SETTINGS
<b>All settings of user programs will be deleted.</b>	
<pre>FACTORY SETTINGS: WARNING! ALL PROGRAMS, SETTINGS AND CONFIGURATION WILL BE LOST. CONTINUE ?                  YES  NO</pre>	<ul style="list-style-type: none"> <li>▪ Via ◀▶ keys choose <b>YES</b> or <b>NO</b>.</li> <li>▪ Confirm by pressing <b>SET</b>.</li> </ul>

# 11. Maintenance

## 11.1 Cleaning of the centrifuge

	<ul style="list-style-type: none"> <li>▪ <b>Pull the mains plug before cleaning.</b></li> <li>▪ <b>Before any cleaning or decontamination process other than that is recommended by the manufacturer, the user has to ask the manufacturer if the planned process does not damage the device</b></li> <li>▪ For cleaning, water with soap or other water-soluble <b>mild detergent</b> shall be used.</li> <li>▪ One should avoid corrosive and aggressive substances.</li> <li>▪ It is prohibited to use alkaline solutions, inflammable solvents or agents containing abrasive particles.</li> <li>▪ Do not lubricate the centrifuge motor shaft.</li> <li>▪ The unused centrifuge should have cover opened. <ul style="list-style-type: none"> <li><b>Once a week</b></li> <li>▪ Using wiping cloth, remove condensate or residues of the products from the rotor chamber.</li> <li><b>Once a month</b></li> <li>▪ Check the condition of the rotor fixing screw thread. If damaged, it must be replaced.</li> </ul> </li> </ul>
---	---

	<ul style="list-style-type: none"> <li>Check the centrifuging chamber whether it is damaged. In case of damage, it cannot be longer put into operation. Notify authorized service workshop.</li> </ul>
--	--

### 11.2 Maintenance of centrifuge elements

	<ul style="list-style-type: none"> <li>The rotor pins shall be always lubricated with petroleum jelly.</li> <li>In this way, the uniform deflection of the buckets and quiet centrifuge operation is ensured.</li> </ul>
---	--

#### Cleaning of the accessories

	<ul style="list-style-type: none"> <li>In order to ensure safe operation, one shall carry out in <b>regular</b> way periodical maintenance of the equipment.</li> <li>Rotors, buckets, and round carriers have to withstand high stresses originating from the centrifugal force. Chemical reactions as well as corrosion (combination of variable pressure and chemical reactions) can cause destruction of metals. Hard to observe surface cracks increase gradually and weaken material without visible symptoms.</li> <li>In case of observation of surface damage, crevice, or other change, as well as the corrosion, the given part (rotor, bucket, etc.) shall be immediately replaced.</li> <li>The rotor, including the fixing screw, buckets and round carriers must be regularly cleaned to prevent corrosion.</li> <li>Cleaning of the accessories shall be carried out outside of the centrifuge <b>once every week</b> or still better after each use. For cleaning them one should use neutral agent of pH value 6÷8. It is forbidden to use alkaline agent of <b>pH &gt; 8</b>. Then, those parts shall be dried using soft fabric or in the chamber drier at ca. 50°C.</li> <li>Angle rotor should be placed on a fabric with holes facing down, for effective drying.</li> <li>Do not use bleach on plastic parts of the rotor.</li> <li>In this way, the useful service life of the device is substantially increased and susceptibility to corrosion is diminished. Accurate maintenance increases the service life as well and protects against premature rotor failures.</li> <li>Do not use bleach on plastic parts of the rotor.</li> <li>According to laboratory standards, minimize the immersion time in each solution.</li> <li>Especially prone to the corrosion are parts made of aluminium.</li> <li>Corrosion and damages resulting from insufficient maintenance could not be subject of claims lodged against the manufacturer.</li> <li>The unused rotor should have the lid removed.</li> </ul>
--	--

#### HS accessories maintenance.

	<ul style="list-style-type: none"> <li>Check the general condition of seals.</li> <li>Make sure that rubber O-rings are lightly coated with silicone grease. Use high vacuum grease, e.g., type „C” by LUBRINA.</li> <li>In order to maintain hermetic sealing, it is recommended to replace the sealing rings after each autoclaving.</li> <li>Store hermetically sealed rotors and buckets with the lids removed.</li> </ul>
---	--

### 11.3 Sterilization

#### Plastics - legend to abbreviations

<b>PS</b>	polystyrene	<b>ECTFE</b>	ethylene/chlorotrifluoroethylene
<b>SAN</b>	styrene-acrylonitrile	<b>ETFE</b>	ethylene/tetrafluoroethylene
<b>PMMA</b>	polymethyl methacrylate	<b>PTFE</b>	polytetrafluoroethylene
<b>PC</b>	polycarbonate	<b>FEP</b>	tetrafluoroethylene/perfluoropropylene

<b>PVC</b>	polyvinyl chloride	<b>PFA</b>	tetrafluoroethylene/perfluoroalkylvinylether
<b>POM</b>	acetal polyoxymethylenel	<b>FKM</b>	fluorcarbon rubber
<b>PE-LD</b>	low density polyethylene	<b>EPDM</b>	ethylene propylene diene
<b>PE-HD</b>	high density polyethylene	<b>NR</b>	natural rubber
<b>PP</b>	polypropylene	<b>SI</b>	silicon rubber
<b>PMP</b>	polymethylpentene		

One can use all standard disinfectants. Centrifuges and devices are made of different materials, one should consider their variety.

	radiation $\beta$ radiation $\gamma$ 25 kGy	C <sub>2</sub> H <sub>4</sub> O (ethylene oxide)	formalin, ethanol
PS	●	○	●
SAN	○	●	●
PMMA	●	○	●
PC	●	●	●
PVC	○	●	●
POM	●	●	●
PE-LD	●	●	●
PE-HD	●	●	●
PP	●	●	●
PMP	●	●	●
ECTFE, ETFE	○	●	●
PTFE	○	●	●
FEP, PFA	○	●	●
FKM	○	●	●
EPDM	○	●	●
NR	○	●	●
SI	○	●	●

- may be used
- cannot be used

In the centrifuge, disinfectants and cleaning agents generally used in medical care should be used (e.g., Aerodesina-2000, Lysoformin 3000, Melseptol, Melsept SF, Sanepidex, Cutasept F).

### 11.3.1 Autoclaving

- Rotors, buckets and round carriers can be sterilized in autoclave with temperature 121°C during 20 min (215 kPa), unless otherwise specified in the OPTIONAL ACCESSORY.
- During sterilization (autoclaved) by means of steam one should consider temperature resistance of individual materials.
- Deformation of the accessories (carriers or lids made of plastic) may occur during autoclaving.
- Do not autoclave disposable materials (e.g., tubes, cyto-container).
- The life of the accessory depends on the frequency of autoclaving and use.
- Autoclaving reduces lifespan of plastic components. They should be replaced if any signs of damage are visible, including a change in colour or shape or when leakage etc.
- Pressure in closed containers can cause plastic deformation or explosion.
- Prior to autoclaving the rotors and accessories, thoroughly wash and rinse with distilled water.
- Never exceed the permissible autoclaving temperature and time.
- If you want to keep the hermetic seals, replace the sealing rings after each autoclave.

## Chemical resistance of plastics

	autoclaving 121 °C, 20 min		autoclaving 121 °C, 20 min
PS	○	PMP	●
SAN	○	ECTFE, ETFE	●
PMMA	○	PTFE	●
PC	●	FEP, PFA	●
PVC	○ <sup>1)</sup>	FKM	●
POM	●	EPDM	●
PE-LD	○	NR	○
PE-HD	○	SI	●
PP	●		

● may be used

○ cannot be used

1) Except PVC hoses which are resistant to the steam sterilization in the temperature 121°C.

## 11.4 Chemical resistance

### Chemical resistance of plastics

	aldehydes	cyclic alcohols	esters	ether	ketones	strong or concentrated acids	weak or diluted acids	oxidizing substances	cyclic hydrocarbons	ahs	haloid hydrocarbons	alkalis
PS	○	●	○	○	○	○/●	○/●	○	○	○	○	●
SAN	○	●	○	○	○	○	○/●	○	○	○	○	●
PMMA	○/●	●	○	○	○	○	○/●	○	○/●	○	○	○
PC	○/●	●	○	○	○	○	○/●	○	○/●	○	○	○
PVC	○	●	○	○	○	●	●	○	●	○	○	●
POM	○/●	●	○	●	●	○	○	○	●	●	●	●
PE-LD		●	●	●	○/●	●	●	○	●	●	●	●
PE-HD	●	●	○/●	○/●	○/●	●	●	○	●	○/●	○/●	●
PP	●	●	○/●	○/●	○/●	●	●	○	●	○/●	○/●	●
PMP	○/●	●	○/●		○/●	●	●	○	○/●	○	○	●
ECTFE ETFE	●	●	●	●	○	●	●	●	●	●	●	●
PTFE FEP PFA	●	●	●	●	●	●	●	●	●	●	●	●
FKM	●	○	○	○	○	○	●	○/●	○/●	○/●	○/●	○/●
EPDM	●	●	○/●	○	○/●	●	●	○/●	○	○	○	●
NR	○/●	●	○/●	○	○	○	○/●	○	○	○	○	●
SI	○/●	●	○/●	○	○	○	○/●	○	○	○	○	○/●

● very good

Permanent action of the substance does not cause damage through 30 days. The material is able to be resistant through years

○/● good to limited



Continuous action of the substance causes insignificant and partly reversible damage through the period of 7-30 days (e.g. puffing up, softening, reduced mechanical durability, discolouring).

○ limited

The material should not have the continuous contact with the substance. The immediate occurrence of damage is possible (e.g. the loss of mechanical durability, deformation, discolouring, bursting, dissolving).

Rubber inserts shall be exactly cleaned or possibly replaced. Centrifuges and accessories are made of different materials.

Do not use bleach on plastic parts of the rotor.

	<b>DANGER!</b> MPW accessories are not biotight. For centrifuging infectious materials, it is necessary to use hermetically closed tubes meeting demands of biotightness, in order to prevent germs migration into the centrifuge and beyond it.
	User is responsible for proper disinfections of the centrifuge if some dangerous material was spilled inside or outside of the centrifuge. During the above mentioned works one must wear safety gloves.

## 12. Troubleshooting

Majority of faults could be removed by switching the centrifuge OFF and then ON. After switching the centrifuge ON, there shall be displayed parameters of the recently implemented program and sound signals comprising four successive tones shall be generated. In case of short-duration power failure the centrifuge terminates the cycle and displays PROGRAM ERROR code.

problem	question	remedy
<b>Centrifuge does not start</b>	<i>Is supply cable plugged into mains?</i>	<i>Plugs supply cable correctly.</i>
	<i>Is master switch ON?</i>	<i>Switch ON power supply.</i>
<b>Motor error is displayed</b>		Call service.
<b>Centrifuge does not start</b>  (indications are proof for cycle in progress and motor does not start)	<i>Is ► symbol displayed?</i>	Wait till rotor stops and the ► symbol goes off.
	<i>Is ◀ symbol displayed?</i>	Close cover. ◀ symbol must switch off.
	<i>Is ■ symbol blinking?</i>	Centrifugation cycle in progress, press STOP key or wait till cycle ends.
<b>Centrifuge does not accelerate</b>  (unbalance error)	<i>Unequal rotor load.</i>	Centrifuge load shall be balanced.
	<i>Inclined centrifuge.</i>	Centrifuge shall be levelled.
	<i>Faulty drive (mechanical damage).</i>	Call service.
	<i>Was centrifuge displaced during operation?</i>	Switch ON the centrifuge again after opening and closing the cover.
<b>(motor error)</b>	<i>After stopping error rotor message is displayed</i>	Check if rotor number in started program is consistent with the number of the rotor installed in the centrifuge. Check rotor status (if there are coding magnets inserted)
	<i>Centrifuge does not recognize the rotor and does not stop.</i>	Switch the centrifuge OFF, then ON and check correctness of loaded program
<b>It is not possible to open the cover</b>	<i>■ symbol on the display is blinking, after pressing COVER key single tone is audible</i>	Rotor is still rotating. Wait for stopping of the rotor and displaying of the ■ symbol.
	<i>The sensor is connected correctly, and the error is still applying.</i>	Call service.
<b>Mains failure during run</b>	<i>The message will be displayed on the display about the decay of tension.</i>	Wait for stopping of the rotor, clear the error by pressing the SET key.
<b>Temperature sensor error</b>	<i>The overheating message will be displayed.</i>	Switch the centrifuge OFF, then ON.
<b>Error of the exceeding the temperature (50°C) in the chamber</b>	<i>The overheating message will be displayed.</i>	Call service.

## 12.1 Messages

Screen messages that may occur during operation.	
MESSAGE	EXPLANATION
"SPEED OF ROTOR" "IDENTIFICATION <> 90 RPM"	Please try start centrifuging again, if error still occur, contact manufacturer's authorized service.
"IMBALANCE FAST STOP !" "PLEASE REMOVE CAUSE" "THEN RESTART"	Rotor is not balanced correctly, please balance rotor.
"NO ROTOR OR IDENTIFICATION" "SENSOR DAMAGED !"	Make sure, is rotor mounted in the centrifuge chamber. If it is right contact manufacturer's authorized service.
"INCORRECT ROTOR NUMBER !"	Change rotor number in centrifuge settings or use autoidentification.
"WRONG DIRECTION OF ROTATION" "OR UNKNOWN ROTOR !"	Make sure if correct rotor for centrifuge is mounted. List of accessories is described in chapter 15.
"PLEASE CLOSE THE LID" "HAND !"	Necessity of manually closing the lid.
"ROTOR STOPPING !" "Please wait..."	Initializing after mains failure with rotating rotor, wait until rotor stop.

### Emergency messages

In case of emergency messages (centrifuge is not working properly) contact the manufacturer's authorized service centre.

MESSAGE
"OVERHEATING MOTOR !" "INVERTER ERROR !"
"INVERTER SERIAL BUS ERROR !"
"TEMPERATURE SENSOR ERROR"
"PRESSURE CONTROL FAILURE!"
"OPENING COVER in RUN!"
"SPEED METER ERROR"
"I2C BUS ERROR"
"OVERHEATING CENTRIFUGE !"
"ROTOR OVERSPEED !"
"COVER LOCK MALFUNCTION !"

## 12.2 Emergency cover release

	<p><b>EMERGENCY COVER RELEASE</b></p> <p><b>Attention!</b> <i>The cover may be opened in emergency only when the rotor is at rest. Before emergency opening the cover, switch off the mains power switch and disconnect the power cord. Wait 10 min and/or looking through the sight glass, make sure that the rotor is not rotating.</i></p> <p>To do this, insert the key into the emergency opening of the cover (Cat. No. 17799) into the hole (you must first remove the plug) on the front of the centrifuge and then turn it anticlockwise until you release the lock and open the cover.</p>
---	--

### 13. Guarantee

Manufacturer grants to the Buyer the guarantee on conditions specified in the Guarantee Certificate. Buyer forfeits the right to guarantee repair when using the device inconsistently with the User manual provisions, when damage results from the User's fault.

Repairs should be carried out in authorized service workshops, granted with the MPW Certificate.

The centrifuge shall be sent to repair after decontaminating disinfections. Information about authorized service workshops could be obtained from the Manufacturer.



- Guarantee period amounts to 24 months (unless otherwise specified in the purchase documents).
- Guarantee conditions are described in guaranteed card.
- The service life of the centrifuge specified by the manufacturer amounts to 10 years.
- After 24 months from the start of the warranty period (date of purchase), a technical inspection of the centrifuge should be carried out (validation) by an authorized service of the manufacturer. Subsequent inspections should be carried out at annual intervals.
- Maximum period of storage of not used centrifuge amounts to 1 year. After this period, a service authorized by manufacturer should carry out technical inspection of the centrifuge.
- Manufacturer reserves the right to make technical changes in manufactured products.



## 14. Transport and storage



**CAUTION!** Due to the heavy weight of the device, lifting and carrying it may cause injury to the spine.

- Store the device only in a closed and dry room.
- Remove rotor from centrifuge before transport.
- Lift and carry with the adequate number of people.
- Use transport equipment.
- Use the original packaging and transport protection for transport.

### Transport and storage conditions.

	Storage (in the package)	Storage (without the package)	Transport
Temperature	-25 ÷ +55 °C	-5 ÷ +45 °C	-25 ÷ +60 °C (general) -20 ÷ +55 °C (air)
Relative humidity	10 ÷ 75 %	10 ÷ 75 %	10 ÷ 75 %
Pressure	70 ÷ 106 kPa	70 ÷ 106 kPa	30 ÷ 106 kPa

## 15. Disposal



- Dispose of the device in accordance with the applicable legal regulations in the country of use.
- In the countries of the European Community, the disposal of electrical equipment is regulated under the EU Directive 2012/19/EU on waste electrical and electronic equipment (WEEE).  
According to these regulations, centrifuges may not be collected together with municipal or household waste.
- Disposal regulations in individual EU countries may differ. In case of doubt, please contact the supplier of the device.

## 16. List of changes in the manual

Rev.	Release date	Description of changes
15	03.04.2023	Addition of markings used in the manual and on the device. Update of nameplate, CE declaration and equipment lists. Updating records regarding the intended use and disposal of the product. Removal of the RTC function.
16	16.06.2023	Updating of the description in the technical data table. Updating the CE declaration of conformity, equipment list and nameplate.
17	17.11.2023	Removal of the USB communication function.
18	12.01.2024	Updated "Installation" chapter, equipment list and name plate.

## 17. Manufacturer's info

"MPW MED. INSTRUMENTS" SPÓŁDZIELNIA PRACY

Boremlowska 46 Street

04-347 Warsaw

tel. (+48) 22 610 56 67 (sales department - POLAND)  
(+48) 22 879 70 46 (sales department - outside POLAND)  
(+48) 22 610 81 07 (service)

fax: (+48) 22 610 55 36

e-mail: mpw@mpw.pl

website: www.mpw.pl

000042924 - number of entry in the Waste Database

PL/CA01-01782 - identification number given by Office for Registration of Medicinal Products, Medical Devices and Biocidal Products.

## Distributor's info

**DISTRIBUTOR:**

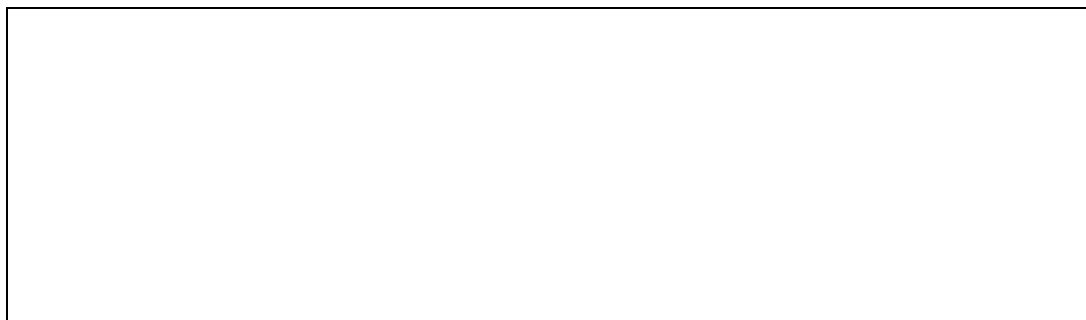

## 18. ANNEXES

**A. Wyposażenie dodatkowe/Optional accessories**

**MPW-380/R**

**WIRNIK / ROTOR**

PARAMETRY/PARAMETERS (RCF [x g], Rmax [mm],  $\alpha$  [°])

POJEMNIK/BUCKET

WKŁADKA / ADAPTER

[liczba probówek na wirnik/tubes per rotor] PROBÓWKA / TUBE

**11762**

**RPM 18000 RCF 30065 Rmax 83  $\alpha$  45**

bez pojemnika/without bucket

bez wkładki/without adapter

[36] \* 2-1,5 ml probówka (10,8x41,8 mm), Eppendorf®; [15011], 2 ml (10,8x41,8 mm); [15128], 1,5ml (10,8x40,5 mm)

[36] \* 2 ml probówki z filtrem - spin columns (10,8 x 46 mm)  
2 ml spin columns (with filter) (10,8 x 46 mm); [15011], 2 ml (10,8x41,8 mm); [15128], 1,5ml

**14084**

[36] \* 0,5 ml probówka PCR (7,8 x 31 mm)  
0,5 ml PCR tube (7,8 x 31 mm)

**14126**

[36] \* 0,4 ml probówka PCR (5,7 x 48,6 mm)  
0,4 ml PCR tube (5,7 x 48,6 mm)

**14133**

[36] \* 0,2 ml probówka PCR (6 x 21,6 mm)  
0,2 ml PCR tube (6 x 21,6 mm)

**11763**

**RPM 16400 RCF 28266 Rmax 94  $\alpha$  45**

bez pojemnika/without bucket

bez wkładki/without adapter

[48] \* 2-1,5 ml probówka (10,8x41,8 mm), Eppendorf®; [15011], 2 ml (10,8x41,8 mm); [15128], 1,5ml (10,8x40,5 mm)

[48] \* 2 ml probówki z filtrem - spin columns (10,8 x 46 mm)  
2 ml spin columns (with filter) (10,8 x 46 mm); [15011], 2 ml (10,8x41,8 mm); [15128], 1,5ml

**14084**

[48] \* 0,5 ml probówka PCR (7,8 x 31 mm)  
0,5 ml PCR tube (7,8 x 31 mm)

**14126**

[48] \* 0,4 ml probówka PCR (5,7 x 48,6 mm)  
0,4 ml PCR tube (5,7 x 48,6 mm)

**14133**

[48] \* 0,2 ml probówka PCR (6 x 21,6 mm)  
0,2 ml PCR tube (6 x 21,6 mm)

**11765**

**RPM 16400 RCF 28566 Rmax 95  $\alpha$  45**

bez pojemnika/without bucket

bez wkładki/without adapter

[12] \* 8 x 0,2 ml probówki szeregowo PCR-strip (10,2 x 72,4 mm)  
8 x 0,2 ml PCR strip (10,2 x 72,4 mm)

[96] \* 0,2 ml probówka PCR (6 x 21,6 mm)  
0,2 ml PCR tube (6 x 21,6 mm)

**11766**

**RPM 18000 RCF 31876 Rmax 88  $\alpha$  45**

bez pojemnika/without bucket

bez wkładki/without adapter

[12] 15121 10 ml probówka z dnem okrągłym i pokrywką (17 x 70 mm)  
10 ml tube, round bottom, with cap (17 x 70 mm)

[12] \* 10 ml Thermo Nalgene® Oak Ridge (16 x 81,5 mm)

**11767**

**RPM 14000 RCF 20598 Rmax 94  $\alpha$  30**

bez pojemnika/without bucket

bez wkładki/without adapter

[12] 15053 10 ml probówka z pokrywką (16 x 106 mm)  
10 ml tube with cap (16 x 106 mm)

[12] 15118 10 ml probówka szklana (16 x 100 mm)  
10 ml glass tube (16 x 100 mm)

RCF max.=3000 RPM max.=5343

\* probówka niedostępna w ofercie MPW lub dostępny odpowiednik (np:[15050]), patrz kolumna z prawej  
tube is not offered by MPW or equivalent is available (e.g. [15050]), see column on the right

**A. Wyposażenie dodatkowe/Optional accessories**
**MPW-380/R**
**11770**
**RPM 14000 RCF 23228 Rmax 106  $\pm$  30**
**bez pojemnika/without bucket**
**bez wkładki/without adapter**

[12] \* 15 ml probówka z dnem stożkowym z zakrętką (17 x 120 mm), Falcon®; [15050], 15ml (17 x 120 mm)  
15 ml tube, conical bottom, with cap (17 x 120 mm), Falcon®; [15050] 15ml Sarstedt® (17 x 120 mm)

**14047**

[12] \* 5 ml probówka z korkiem (12 x 85 mm), Sarstedt®  
5 ml tube with cap (12 x 85 mm), Sarstedt®

**14868**

[12] \* 5 ml probówka z korkiem wciskany (17 x 54,2 mm), Eppendorf®  
5 ml tube with snap cap (17 x 54,2 mm), Eppendorf®

[12] \* 5 ml probówka z korkiem zakręcany (17 x 66 mm), Eppendorf®  
5 ml tube with screw cap (17 x 66 mm), Eppendorf®

**11772**
**RPM 17500 RCF 29788 Rmax 87  $\pm$  30**
**bez pojemnika/without bucket**
**bez wkładki/without adapter**

[8] \* 30 ml probówka z pokrywką (25,5 x 94 mm), Nalgene®  
30 ml tube with cap (25,5 x 94 mm), Nalgene®

[8] \* 30 ml Thermo Nalgene® Oak Ridge (25,5 x 94,3 mm)  
30 ml Thermo Nalgene® Oak Ridge (25,5 x 94,3 mm)

**11775**
**RPM 14000 RCF 21255 Rmax 97  $\pm$  30**
**bez pojemnika/without bucket**
**bez wkładki/without adapter**

[8] 15051 50 ml Thermo Nalgene® Oak Ridge (28,8 x 106,7 mm)  
50 ml Thermo Nalgene® Oak Ridge (28,8 x 106,7 mm)

**14035**

[8] 15046 14 ml probówka z pokrywką (16,8 x 113,7 mm), Sarstedt®  
14 ml tube with cap (16,8 x 113,7 mm), Sarstedt®

[8] 15053 10 ml probówka z pokrywką (16 x 106 mm)  
10 ml tube with cap (16 x 106 mm)

[8] 15118 10 ml probówka szklana (16 x 100 mm)  
10 ml glass tube (16 x 100 mm)

RCF max.=3000 RPM max.=5260

[8] \* 15 ml Thermo Nalgene® (16 x 113 mm)  
15 ml Thermo Nalgene® (16 x 113 mm)

**14036**

[8] \* 7 ml probówka szklana (12 x 100 mm)  
7 ml glass tube (12 x 100 mm)

RCF max.=3000 RPM max.=5260

[8] \* 6 ml probówka z pokrywką (11,5 x 92 mm), Sarstedt®  
6 ml tube with cap (11,5 x 92 mm), Sarstedt®

**11776**
**RPM 14000 RCF 23666 Rmax 108  $\pm$  30**
**bez pojemnika/without bucket**
**bez wkładki/without adapter**

[8] \* 50 ml probówka z dnem stożkowym z zakrętką (30 x 117 mm), Falcon®; [15052] 50ml (30 x 117mm)  
50 ml tube, conical bottom, with cap (30 x 117 mm), Falcon®; [15052] 50ml Sarstedt® (30 x 117 mm)

[8] \* 50 ml probówka z dnem stożkowym bez rantu (30 x 115 mm), Greiner®  
50 ml tube, conical bottom, without skirt (30 x 115 mm), Greiner®

**14043**

[8] \* Greiner Vacuette® (13 x 75 mm), (1-4,5 ml)

[8] \* 5 ml probówka z korkiem (12 x 85 mm), Sarstedt®  
5 ml tube with cap (12 x 85 mm), Sarstedt®

[8] \* 5 ml probówka szklana (12 x 75 mm)  
5 ml glass tube (12 x 75 mm)

RCF max.=3000 RPM max.=4985

**14071**

[8] 15055 30 ml probówka z pokrywką (25,4 x 103,2 mm)  
30 ml tube with cap (25,4 x 103,2 mm)

[8] \* 28 ml Thermo Nalgene® Oak Ridge (25,4 x 101,8 mm)

[8] \* 30 ml probówka z pokrywką (25,5 x 94 mm), Nalgene®  
30 ml tube with cap (25,5 x 94 mm), Nalgene®

[8] \* 30 ml Thermo Nalgene® Oak Ridge (25,5 x 94,3 mm)  
30 ml Thermo Nalgene® Oak Ridge (25,5 x 94,3 mm)

**14073**

[8] 15046 14 ml probówka z pokrywką (16,8 x 113,7 mm), Sarstedt®  
14 ml tube with cap (16,8 x 113,7 mm), Sarstedt®

[8] 15053 10 ml probówka z pokrywką (16 x 106 mm)  
10 ml tube with cap (16 x 106 mm)

[8] \* BD Vacutainer® (16 x 100 mm), (2,5-11 ml)

\* probówka niedostępna w ofercie MPW lub dostępny odpowiednik (np.[15050]), patrz kolumna z prawej  
tube is not offered by MPW or equivalent is available (e.g. [15050]), see column on the right

**A. Wyposażenie dodatkowe/Optional accessories**
**MPW-380/R**

[8]	*	Greiner Vacuette® (16 x 100 mm), (7-9 ml)
[8]	*	Sarstedt S-Monovette® (15 x 92 mm), (7,5; 8,2; 8,5 ml)
[8]	*	Sarstedt S-Monovette® (16 x 92 mm), (9; 10 ml)
[8]	15118	10 ml probówka szklana (16 x 100 mm) 10 ml glass tube (16 x 100 mm) RCF max.=3000 RPM max.=4985
<b>14089</b>		
[8]	*	15 ml probówka z dnem stożkowym z zakrętką (17 x 120 mm), Falcon®; [15050], 15ml (17 x 120 mm) 15 ml tube, conical bottom, with cap (17 x 120 mm), Falcon®; [15050] 15ml Sarstedt®(17 x 120 mm)
<b>14089+14868</b>		
[8]	*	5 ml probówka z korkiem wciskany (17 x 54,2 mm), Eppendorf® 5 ml tube with snap cap (17 x 54,2 mm), Eppendorf®
[8]	*	5 ml probówka z korkiem zakręcany (17 x 66 mm), Eppendorf® 5 ml tube with screw cap (17 x 66 mm), Eppendorf®
<b>11777</b>		
<b>RPM 10000 RCF 14087 Rmax 126 4 25</b>		
<b>bez pojemnika/without bucket</b>		
<b>14017</b>		
[4]	*	250 ml butelka okrągłodenna (62 x 122 mm), Herolab® nr 25 34 43 250 ml round-bottom bottle (62 x 122 mm), Herolab® no. 25 34 43
<b>14152</b>		
[4]	*	50 ml probówka z dnem stożkowym z zakrętką (30 x 117 mm), Falcon®; [15052] 50ml (30 x 117mm) 50 ml tube, conical bottom, with cap (30 x 117 mm), Falcon®; [15052] 50ml Sarstedt® (30 x 117 mm)
[4]	*	50 ml probówka z dnem stożkowym bez rantu (30 x 115 mm), Greiner® 50 ml tube, conical bottom, without skirt (30 x 115 mm), Greiner®
<b>14175</b>		
[4]	15175	250 ml butelka płaskodenna (62 x 122 mm), Herolab® nr 25 34 21 250 ml bottle, flat bottom (62 x 122 mm), Herolab® no. 25 34 21
[4]	15176	250 ml butelka płaskodenna (62 x 122 mm), Herolab® nr 25 34 01 250 ml bottle, flat bottom (62 x 122 mm), Herolab® no. 25 34 01
<b>11778</b>		
<b>RPM 12000 RCF 17709 Rmax 110 4 30</b>		
<b>bez pojemnika/without bucket</b>		
<b>bez wkładki/without adapter</b>		
[6]	*	85 ml Thermo Nalgene® Oak Ridge (38,2 x 105,7 mm) 85 ml Thermo Nalgene® Oak Ridge (38,2 x 105,7 mm)
<b>14855</b>		
[6]	*	50 ml probówka z dnem stożkowym z zakrętką (30 x 117 mm), Falcon®; [15052] 50ml (30 x 117mm) 50 ml tube, conical bottom, with cap (30 x 117 mm), Falcon®; [15052] 50ml Sarstedt® (30 x 117 mm)
[6]	*	50 ml probówka z dnem stożkowym bez rantu (30 x 115 mm), Greiner® 50 ml tube, conical bottom, without skirt (30 x 115 mm), Greiner®
<b>14856</b>		
[6]	*	15 ml probówka z dnem stożkowym z zakrętką (17 x 120 mm), Falcon®; [15050], 15ml (17 x 120 mm) 15 ml tube, conical bottom, with cap (17 x 120 mm), Falcon®; [15050] 15ml Sarstedt®(17 x 120 mm)
<b>11779</b>		
<b>RPM 15000 RCF 22136 Rmax 88 4 45</b>		
<b>bez pojemnika/without bucket</b>		
<b>bez wkładki/without adapter</b>		
[36]	*	2-1,5 ml probówka (10,8x41,8 mm), Eppendorf®; [15011], 2 ml (10,8x41,8 mm); [15128], 1,5ml (10,8x40,5 mm)
[36]	*	2 ml próbki z filtrem - spin columns (10,8 x 46 mm) 2 ml spin columns (with filter) (10,8 x 46 mm); [15011], 2 ml (10,8x41,8 mm); [15128], 1,5ml
<b>14084</b>		
[36]	*	0,5 ml probówka PCR (7,8 x 31 mm) 0,5 ml PCR tube (7,8 x 31 mm)
<b>14126</b>		
[36]	*	0,4 ml probówka PCR (5,7 x 48,6 mm) 0,4 ml PCR tube (5,7 x 48,6 mm)
<b>14133</b>		
[36]	*	0,2 ml probówka PCR (6 x 21,6 mm) 0,2 ml PCR tube (6 x 21,6 mm)
<b>11780</b>		
<b>RPM 4500 RCF 3328 Rmax 147 4 30</b>		
<b>13276</b>		
<b>bez wkładki/without adapter</b>		
[12]	15051	50 ml Thermo Nalgene® Oak Ridge (28,8 x 106,7 mm) 50 ml Thermo Nalgene® Oak Ridge (28,8 x 106,7 mm)
[12]	*	50 ml probówka z dnem stożkowym z zakrętką (30 x 117 mm), Falcon®; [15052] 50ml (30 x 117mm) 50 ml tube, conical bottom, with cap (30 x 117 mm), Falcon®; [15052] 50ml Sarstedt® (30 x 117 mm)
[12]	*	50 ml probówka z dnem stożkowym bez rantu (30 x 115 mm), Greiner® 50 ml tube, conical bottom, without skirt (30 x 115 mm), Greiner®
[12]	*	50 ml probówka Advanced Oak Ridge (29x102 mm), Herolab® nr 25 32 11 50 ml tube, Advanced Oak Ridge (29 x 102 mm), Herolab® no. 25 32 11

\* probówka niedostępna w ofercie MPW lub dostępny odpowiednik (np.[15050]), patrz kolumna z prawej  
tube is not offered by MPW or equivalent is available (e.g. [15050]), see column on the right

**A. Wyposażenie dodatkowe/Optional accessories**
**MPW-380/R**
**14035**

- [12] 15046 14 ml probówka z pokrywką (16,8 x 113,7 mm), Sarstedt®  
14 ml tube with cap (16,8 x 113,7 mm), Sarstedt®
- [12] 15053 10 ml probówka z pokrywką (16 x 106 mm)  
10 ml tube with cap (16 x 106 mm)
- [12] 15118 10 ml probówka szklana (16 x 100 mm)  
10 ml glass tube (16 x 100 mm)  
RCF max.=3000 RPM max.=4272
- [12] \* 15 ml Thermo Nalgene® (16 x 113 mm)  
15 ml Thermo Nalgene® (16 x 113 mm)

**14036**

- [12] \* BD Vacutainer® (13 x 100 mm), (4-7 ml)
- [12] \* 7 ml probówka szklana (12 x 100 mm)  
7 ml glass tube (12 x 100 mm)  
RCF max.=3000 RPM max.=4272
- [12] \* 6 ml probówka z pokrywką (11,5 x 92 mm), Sarstedt®  
6 ml tube with cap (11,5 x 92 mm), Sarstedt®

**14043**

- [12] \* Greiner Vacuette® (13 x 75 mm), (1-4,5 ml)
- [12] \* Sarstedt S-Monovette® (13 x 75 mm), (2,7; 3; 4,3 ml)
- [12] \* Sarstedt S-Monovette® (13 x 90 mm), (4,9; 5,6 ml)
- [12] \* 5 ml probówka z korkiem (12 x 85 mm), Sarstedt®  
5 ml tube with cap (12 x 85 mm), Sarstedt®
- [12] \* 5 ml probówka szklana (12 x 75 mm)  
5 ml glass tube (12 x 75 mm)  
RCF max.=3000 RPM max.=4272

**14071**

- [12] 15055 30 ml probówka z pokrywką (25,4 x 103,2 mm)  
30 ml tube with cap (25,4 x 103,2 mm)
- [12] \* 28 ml Thermo Nalgene® Oak Ridge (25,4 x 101,8 mm)
- [12] \* 30 ml probówka z pokrywką (25,5 x 94 mm), Nalgene®  
30 ml tube with cap (25,5 x 94 mm), Nalgene®
- [12] \* 30 ml Thermo Nalgene® Oak Ridge (25,5 x 94,3 mm)  
30 ml Thermo Nalgene® Oak Ridge (25,5 x 94,3 mm)

**14073**

- [12] 15046 14 ml probówka z pokrywką (16,8 x 113,7 mm), Sarstedt®  
14 ml tube with cap (16,8 x 113,7 mm), Sarstedt®
- [12] 15053 10 ml probówka z pokrywką (16 x 106 mm)  
10 ml tube with cap (16 x 106 mm)
- [12] \* BD Vacutainer® (16 x 100 mm), (2,5-11 ml)
- [12] \* Greiner Vacuette® (16 x 100 mm), (7-9 ml)
- [12] \* Sarstedt S-Monovette® (15 x 92 mm), (7,5; 8,2; 8,5 ml)
- [12] \* Sarstedt S-Monovette® (16 x 92 mm), (9; 10 ml)
- [12] 15118 10 ml probówka szklana (16 x 100 mm)  
10 ml glass tube (16 x 100 mm)  
RCF max.=3000 RPM max.=4272

**14089**

- [12] \* 15 ml probówka z dnem stożkowym z zakrętką (17 x 120 mm), Falcon®; [15050], 15ml (17 x 120 mm)  
15 ml tube, conical bottom, with cap (17 x 120 mm), Falcon®; [15050] 15ml Sarstedt®(17 x 120 mm)

**14248**

- [12] 15055 30 ml probówka z pokrywką (25,4 x 103,2 mm)  
30 ml tube with cap (25,4 x 103,2 mm)

**14089+14868**

- [12] \* 5 ml probówka z korkiem wciskany (17 x 54,2 mm), Eppendorf®  
5 ml tube with snap cap (17 x 54,2 mm), Eppendorf®
- [12] \* 5 ml probówka z korkiem zakręcany (17 x 66 mm), Eppendorf®  
5 ml tube with screw cap (17 x 66 mm), Eppendorf®

**13278+17151**
**bez wkładki/without adapter**

- [12] 15051 50 ml Thermo Nalgene® Oak Ridge (28,8 x 106,7 mm)  
50 ml Thermo Nalgene® Oak Ridge (28,8 x 106,7 mm)
- [12] \* 50 ml probówka z dnem stożkowym z zakrętką (30 x 117 mm), Falcon®; [15052] 50ml (30 x 117mm)  
50 ml tube, conical bottom, with cap (30 x 117 mm), Falcon®; [15052] 50ml Sarstedt® (30 x 117 mm)
- [12] \* 50 ml probówka z dnem stożkowym bez rantu (30 x 115 mm), Greiner®  
50 ml tube, conical bottom, without skirt (30 x 115 mm), Greiner®
- [12] \* 50 ml probówka Advanced Oak Ridge (29x102 mm), Herolab® nr 25 32 11  
50 ml tube, Advanced Oak Ridge (29 x 102 mm), Herolab® no. 25 32 11

**14035**

- [12] 15046 14 ml probówka z pokrywką (16,8 x 113,7 mm), Sarstedt®  
14 ml tube with cap (16,8 x 113,7 mm), Sarstedt®
- [12] 15053 10 ml probówka z pokrywką (16 x 106 mm)  
10 ml tube with cap (16 x 106 mm)
- [12] 15118 10 ml probówka szklana (16 x 100 mm)  
10 ml glass tube (16 x 100 mm)  
RCF max.=3000 RPM max.=4272

**A. Wyposażenie dodatkowe/Optional accessories**
**MPW-380/R**

[12]	*	15 ml Thermo Nalgene® (16 x 113 mm) 15 ml Thermo Nalgene® (16 x 113 mm)
<b>14036</b>		
[12]	*	7 ml probówka szklana (12 x 100 mm) 7 ml glass tube (12 x 100 mm) RCF max.=3000 RPM max.=4272
[12]	*	6 ml probówka z pokrywką (11,5 x 92 mm), Sarstedt® 6 ml tube with cap (11,5 x 92 mm), Sarstedt®
<b>14043</b>		
[12]	*	Greiner Vacuette® (13 x 75 mm), (1-4,5 ml)
[12]	*	5 ml probówka z korkiem (12 x 85 mm), Sarstedt® 5 ml tube with cap (12 x 85 mm), Sarstedt®
[12]	*	5 ml probówka szklana (12 x 75 mm) 5 ml glass tube (12 x 75 mm) RCF max.=3000 RPM max.=4272
<b>14071</b>		
[12]	15055	30 ml probówka z pokrywką (25,4 x 103,2 mm) 30 ml tube with cap (25,4 x 103,2 mm)
[12]	*	28 ml Thermo Nalgene® Oak Ridge (25,4 x 101,8 mm)
[12]	*	30 ml probówka z pokrywką (25,5 x 94 mm), Nalgene® 30 ml tube with cap (25,5 x 94 mm), Nalgene®
[12]	*	30 ml Thermo Nalgene® Oak Ridge (25,5 x 94,3 mm) 30 ml Thermo Nalgene® Oak Ridge (25,5 x 94,3 mm)
<b>14073</b>		
[12]	15046	14 ml probówka z pokrywką (16,8 x 113,7 mm), Sarstedt® 14 ml tube with cap (16,8 x 113,7 mm), Sarstedt®
[12]	15053	10 ml probówka z pokrywką (16 x 106 mm) 10 ml tube with cap (16 x 106 mm)
[12]	*	BD Vacutainer® (16 x 100 mm), (2,5-11 ml)
[12]	*	Greiner Vacuette® (16 x 100 mm), (7-9 ml)
[12]	*	Sarstedt S-Monovette® (15 x 92 mm), (7,5; 8,2; 8,5 ml)
[12]	*	Sarstedt S-Monovette® (16 x 92 mm), (9; 10 ml)
[12]	15118	10 ml probówka szklana (16 x 100 mm) 10 ml glass tube (16 x 100 mm) RCF max.=3000 RPM max.=4272
<b>14089</b>		
[12]	*	15 ml probówka z dnem stożkowym z zakrętką (17 x 120 mm), Falcon®; [15050], 15ml (17 x 120 mm) 15 ml tube, conical bottom, with cap (17 x 120 mm), Falcon®; [15050] 15ml Sarstedt®(17 x 120 mm)
<b>14248</b>		
[12]	15055	30 ml probówka z pokrywką (25,4 x 103,2 mm) 30 ml tube with cap (25,4 x 103,2 mm)
<b>14089+14868</b>		
[12]	*	5 ml probówka z korkiem wciskany (17 x 54,2 mm), Eppendorf® 5 ml tube with snap cap (17 x 54,2 mm), Eppendorf®
<b>11789</b>		
<b>RPM 4700 RCF 4297 Rmax 174 <math>\pm</math> 30</b>		
<b>13080</b>		
<b>14082</b>		
[48]	*	BD Vacutainer® (13 x 100 mm), (4-7 ml)
[48]	*	Greiner Vacuette® (13 x 100 mm), (3,5-6 ml)
[48]	*	Sarstedt S-Monovette® (11 x 92 mm), (4,5; 5 ml)
[48]	*	7 ml probówka szklana (12 x 100 mm) 7 ml glass tube (12 x 100 mm) RCF max.=3000 RPM max.=3927
[48]	*	6 ml probówka z pokrywką (11,5 x 92 mm), Sarstedt® 6 ml tube with cap (11,5 x 92 mm), Sarstedt®
<b>bez wkładki/without adapter</b>		
[48]	15046	14 ml probówka z pokrywką (16,8 x 113,7 mm), Sarstedt® 14 ml tube with cap (16,8 x 113,7 mm), Sarstedt®
[48]	15053	10 ml probówka z pokrywką (16 x 106 mm) 10 ml tube with cap (16 x 106 mm)
[48]	*	15 ml probówka z dnem stożkowym z zakrętką (17 x 120 mm), Falcon®; [15050], 15ml (17 x 120 mm) 15 ml tube, conical bottom, with cap (17 x 120 mm), Falcon®; [15050] 15ml Sarstedt®(17 x 120 mm)
[48]	*	BD Vacutainer® (16 x 100 mm), (2,5-11 ml)
[48]	*	Greiner Vacuette® (16 x 100 mm), (7-9 ml)
[48]	*	Sarstedt S-Monovette® (15 x 92 mm), (7,5; 8,2; 8,5 ml)
[48]	*	Sarstedt S-Monovette® (16 x 92 mm), (9; 10 ml)
[48]	15118	10 ml probówka szklana (16 x 100 mm) 10 ml glass tube (16 x 100 mm) RCF max.=3000 RPM max.=3927
[48]	*	15 ml Thermo Nalgene® (16 x 113 mm) 15 ml Thermo Nalgene® (16 x 113 mm)
<b>14082+14815</b>		
[48]	*	5 ml probówka szklana (12 x 75 mm) 5 ml glass tube (12 x 75 mm) RCF max.=3000 RPM max.=4147

\* probówka niedostępna w ofercie MPW lub dostępny odpowiednik (np.[15050]), patrz kolumna z prawej  
tube is not offered by MPW or equivalent is available (e.g. [15050]), see column on the right

**A. Wyposażenie dodatkowe/Optional accessories**
**MPW-380/R**
**14082+14815 Rmax 156 RCF 3853**

[48]	*	BD Vacutainer® (13 x 75 mm), (1,6-5,3 ml)
[48]	*	Greiner Vacuette® (13 x 75 mm), (1-4,5 ml)
[48]	*	Sarstedt S-Monovette® (11 x 66 mm), (1,6; 2; 2,7; 3; 3,1 ml)
[48]	*	Sarstedt S-Monovette® (13 x 65 mm), (2,6; 2,9; 3,4; 3,8 ml)
[48]	*	Sarstedt S-Monovette® (13 x 75 mm), (2,7; 3; 4,3 ml)

**14815 Rmax 156 RCF 3853**

[48]	15121	10 ml probówka z dnem okrągłym i pokrywką (17 x 70 mm) 10 ml tube, round bottom, with cap (17 x 70 mm)
[48]	*	Sarstedt S-Monovette® (15 x 75 mm), (4; 4,3; 5,5 ml)
[48]	*	10 ml Thermo Nalgene® Oak Ridge (16 x 81,5 mm)

**12787**
**RPM 4300 RCF 2398 Rmax 116  $\angle$  90**
**13286**
**bez wkładki/without adapter**

[2]	*	plytka titracyjna DWP 96/2000µl (127,8x85,5x44,1 mm) deepwell plate DWP 96/2000µl (127,8 x 85,5 x 44,1 mm)
[4]	*	plytka titracyjna MTP 28,8ml (86x128x15/17,5 mm) microtiter plate MTP 28,8 ml (86 x 128 x 15/17,5 mm)

**12788**
**RPM 4000 RCF 2826 Rmax 158  $\angle$  90**
**13789**
**bez wkładki/without adapter**

[4]	*	plytka titracyjna DWP 96/2000µl (127,8x85,5x44,1 mm) deepwell plate DWP 96/2000µl (127,8 x 85,5 x 44,1 mm)
[8]	*	plytka titracyjna MTP 28,8ml (86x128x15/17,5 mm) microtiter plate MTP 28,8 ml (86 x 128 x 15/17,5 mm)

**12791**
**RPM 2500 RCF 1293 Rmax 185  $\angle$  90**
**13792+17792**
**14794**

[4]	15797	100 ml pojemnik szklany ASTM (96 x 160 mm) 100 ml ASTM glass bucket (96 x 160 mm)
-----	-------	--

**14795**

[4]	15796	100 ml pojemnik szklany ASTM (96 x 167 mm) 100 ml ASTM glass bucket (96 x 167 mm)
-----	-------	--

**12870**
**RPM 4000 RCF 3309 Rmax 185  $\angle$  90**
**13831**
**14121**

[28]	15222	30 ml probówka z pokrywką (25 x 94mm), Sterilin® 30 ml tube with cap (25 x 94 mm), Sterilin®
[28]	15223	30 ml probówka z pokrywką (25 x 94 mm), Sterilin® 30 ml tube with cap (25 x 94 mm), Sterilin®

**14837**

[64]	15046	14 ml probówka z pokrywką (16,8 x 113,7 mm), Sarstedt® 14 ml tube with cap (16,8 x 113,7 mm), Sarstedt®
[64]	15053	10 ml probówka z pokrywką (16 x 106 mm) 10 ml tube with cap (16 x 106 mm)
[64]	*	BD Vacutainer® (16 x 100 mm), (2,5-11 ml)
[64]	*	Greiner Vacuette® (16 x 100 mm), (7-9 ml)
[64]	*	Sarstedt S-Monovette® (15 x 75 mm), (4; 4,3; 5,5 ml)
[64]	*	Sarstedt S-Monovette® (15 x 92 mm), (7,5; 8,2; 8,5 ml)
[64]	*	Sarstedt S-Monovette® (16 x 92 mm), (9; 10 ml)
[64]	*	10 ml Thermo Nalgene® Oak Ridge (16 x 81,5 mm)
[64]	15118	10 ml probówka szklana (16 x 100 mm) 10 ml glass tube (16 x 100 mm)
[64]	*	15 ml Thermo Nalgene® (16 x 113 mm) 15 ml Thermo Nalgene® (16 x 113 mm)

**14838**

[48]	*	15 ml probówka z dnem stożkowym z zakrętką (17 x 120 mm), Falcon®; [15050], 15ml (17 x 120 mm) 15 ml tube, conical bottom, with cap (17 x 120 mm), Falcon®; [15050] 15ml Sarstedt®(17 x 120 mm)
------	---	--

**14839**

[32]	15055	30 ml probówka z pokrywką (25,4 x 103,2 mm) 30 ml tube with cap (25,4 x 103,2 mm)
[32]	*	28 ml Thermo Nalgene® Oak Ridge (25,4 x 101,8 mm)
[32]	*	30 ml probówka z pokrywką (25,5 x 94 mm), Nalgene® 30 ml tube with cap (25,5 x 94 mm), Nalgene®
[32]	*	30 ml Thermo Nalgene® Oak Ridge (25,5 x 94,3 mm) 30 ml Thermo Nalgene® Oak Ridge (25,5 x 94,3 mm)
[32]	*	25 ml probówka szklana (25 x 100 mm) 25 ml glass tube (25 x 100 mm)

**14840**

\* probówka niedostępna w ofercie MPW lub dostępny odpowiednik (np.[15050]), patrz kolumna z prawej  
tube is not offered by MPW or equivalent is available (e.g. [15050]), see column on the right



**A. Wyposażenie dodatkowe/Optional accessories**
**MPW-380/R**

[20]	*	50 ml probówka z dnem stożkowym z zakrętką (30 x 117 mm), Falcon®; [15052] 50ml (30 x 117mm) 50 ml tube, conical bottom, with cap (30 x 117 mm), Falcon®; [15052] 50ml Sarstedt® (30 x 117 mm)
[20]	*	50 ml probówka z dnem stożkowym bez rantu (30 x 115 mm), Greiner® 50 ml tube, conical bottom, without skirt (30 x 115 mm), Greiner®
<b>14841</b>		
[8]	15040	100 ml probówka z pokrywką (45,2 x 103,7 mm) 100 ml tube with cap (45,2 x 103,7 mm)
[8]	*	100 ml probówka szklana (44 x 100 mm) 100 ml glass tube (44 x 100 mm)
<b>14844</b>		
[104]	*	2-1,5 ml probówka (10,8x41,8 mm), Eppendorf®; [15011], 2 ml (10,8x41,8 mm); [15128], 1,5ml (10,8x40,5 mm)
[104]	*	2 ml probówki z filtrem - spin columns (10,8 x 46 mm) 2 ml spin columns (with filter) (10,8 x 46 mm); [15011], 2 ml (10,8x41,8 mm); [15128], 1,5ml
<b>14860</b>		
[112]	*	Sarstedt S-Monovette® (8 x 66 mm), (1,1; 1,2; 1,4 ml) Sarstedt S-Monovette® (8 x 66 mm), (1,1; 1,2; 1,4 ml)
<b>14862</b>		
[100]	*	Sarstedt S-Monovette® (11 x 66 mm), (1,6; 2; 2,7; 3; 3,1 ml)
[100]	*	Sarstedt S-Monovette® (11 x 92 mm), (4,5; 5 ml)
[100]	*	7 ml probówka szklana (12 x 100 mm) 7 ml glass tube (12 x 100 mm)
[100]	*	5 ml probówka szklana (12 x 75 mm) 5 ml glass tube (12 x 75 mm)
[100]	*	5 ml probówka z korkiem (12 x 85 mm), Sarstedt® 5 ml tube with cap (12 x 85 mm), Sarstedt®
[100]	*	6 ml probówka z pokrywką (11,5 x 92 mm), Sarstedt® 6 ml tube with cap (11,5 x 92 mm), Sarstedt®
<b>14863</b>		
[96]	*	BD Vacutainer® (13 x 75 mm), (1,6-5,3 ml)
[96]	*	BD Vacutainer® (13 x 100 mm), (4-7 ml)
[96]	*	Greiner Vacuette® (13 x 75 mm), (1-4,5 ml)
[96]	*	Greiner Vacuette® (13 x 100 mm), (3,5-6 ml)
[96]	*	Sarstedt S-Monovette® (13 x 75 mm), (2,7; 3; 4,3 ml)
[96]	*	Sarstedt S-Monovette® (11 x 92 mm), (4,5; 5 ml)
[96]	*	Sarstedt S-Monovette® (13 x 65 mm), (2,6; 2,9; 3,4; 3,8 ml)
[96]	*	Sarstedt S-Monovette® (13 x 90 mm), (4,9; 5,6 ml)
[96]	*	5 ml probówka szklana (12 x 75 mm) 5 ml glass tube (12 x 75 mm)
[96]	*	5 ml probówka z korkiem (12 x 85 mm), Sarstedt® 5 ml tube with cap (12 x 85 mm), Sarstedt®
[96]	*	6 ml probówka z pokrywką (11,5 x 92 mm), Sarstedt® 6 ml tube with cap (11,5 x 92 mm), Sarstedt®
<b>14842+14017</b>		
[4]	*	250 ml butelka okrągłodenna (62 x 122 mm), Herolab® nr 25 34 43 250 ml round-bottom bottle (62 x 122 mm), Herolab® no. 25 34 43
<b>14842+14175</b>		
[4]	15175	250 ml butelka płaskodenna (62 x 122 mm), Herolab® nr 25 34 21 250 ml bottle, flat bottom (62 x 122 mm), Herolab® no. 25 34 21
[4]	15176	250 ml butelka płaskodenna (62 x 122 mm), Herolab® nr 25 34 01 250 ml bottle, flat bottom (62 x 122 mm), Herolab® no. 25 34 01
<b>13831+17832</b>		
<b>14121</b>		
[28]	15222	30 ml probówka z pokrywką (25 x 94mm), Sterilin® 30 ml tube with cap (25 x 94 mm), Sterilin®
[28]	15223	30 ml probówka z pokrywką (25 x 94 mm), Sterilin® 30 ml tube with cap (25 x 94 mm), Sterilin®
<b>14837</b>		
[64]	15046	14 ml probówka z pokrywką (16,8 x 113,7 mm), Sarstedt® 14 ml tube with cap (16,8 x 113,7 mm), Sarstedt®
[64]	15053	10 ml probówka z pokrywką (16 x 106 mm) 10 ml tube with cap (16 x 106 mm)
[64]	*	BD Vacutainer® (16 x 100 mm), (2,5-11 ml)
[64]	*	Greiner Vacuette® (16 x 100 mm), (7-9 ml)
[64]	*	Sarstedt S-Monovette® (15 x 75 mm), (4; 4,3; 5,5 ml)
[64]	*	Sarstedt S-Monovette® (15 x 92 mm), (7,5; 8,2; 8,5 ml)
[64]	*	Sarstedt S-Monovette® (16 x 92 mm), (9; 10 ml)
[64]	*	10 ml Thermo Nalgene® Oak Ridge (16 x 81,5 mm)
[64]	15118	10 ml probówka szklana (16 x 100 mm) 10 ml glass tube (16 x 100 mm)
[64]	*	15 ml Thermo Nalgene® (16 x 113 mm) 15 ml Thermo Nalgene® (16 x 113 mm)
<b>14838</b>		
[48]	*	15 ml probówka z dnem stożkowym z zakrętką (17 x 120 mm), Falcon®; [15050], 15ml (17 x 120 mm) 15 ml tube, conical bottom, with cap (17 x 120 mm), Falcon®; [15050] 15ml Sarstedt®(17 x 120 mm)
<b>14839</b>		

\* probówka niedostępna w ofercie MPW lub dostępny odpowiednik (np.[15050]), patrz kolumna z prawej  
tube is not offered by MPW or equivalent is available (e.g. [15050]), see column on the right

**A. Wyposażenie dodatkowe/Optional accessories**
**MPW-380/R**

[32]	15055	30 ml probówka z pokrywką (25,4 x 103,2 mm) 30 ml tube with cap (25,4 x 103,2 mm)
[32]	*	28 ml Thermo Nalgene® Oak Ridge (25,4 x 101,8 mm)
[32]	*	30 ml probówka z pokrywką (25,5 x 94 mm), Nalgene® 30 ml tube with cap (25,5 x 94 mm), Nalgene®
[32]	*	30 ml Thermo Nalgene® Oak Ridge (25,5 x 94,3 mm) 30 ml Thermo Nalgene® Oak Ridge (25,5 x 94,3 mm)
[32]	*	25 ml probówka szklana (25 x 100 mm) 25 ml glass tube (25 x 100 mm)
<b>14840</b>		
[20]	*	50 ml probówka z dnem stożkowym z zakrętką (30 x 117 mm), Falcon®; [15052] 50ml (30 x 117mm) 50 ml tube, conical bottom, with cap (30 x 117 mm), Falcon®; [15052] 50ml Sarstedt® (30 x 117 mm)
[20]	*	50 ml probówka z dnem stożkowym bez rantu (30 x 115 mm), Greiner® 50 ml tube, conical bottom, without skirt (30 x 115 mm), Greiner®
<b>14841</b>		
[8]	15040	100 ml probówka z pokrywką (45,2 x 103,7 mm) 100 ml tube with cap (45,2 x 103,7 mm)
[8]	*	100 ml probówka szklana (44 x 100 mm) 100 ml glass tube (44 x 100 mm)
<b>14844</b>		
[104]	*	2-1,5 ml probówka (10,8x41,8 mm), Eppendorf®; [15011], 2 ml (10,8x41,8 mm); [15128], 1,5ml (10,8x40,5 mm)
[104]	*	2 ml probówki z filtrem - spin columns (10,8 x 46 mm) 2 ml spin columns (with filter) (10,8 x 46 mm); [15011], 2 ml (10,8x41,8 mm); [15128], 1,5ml
<b>14860</b>		
[112]	*	Sarstedt S-Monovette® (8 x 66 mm), (1,1; 1,2; 1,4 ml) Sarstedt S-Monovette® (8 x 66 mm), (1,1; 1,2; 1,4 ml)
<b>14862</b>		
[100]	*	Sarstedt S-Monovette® (11 x 66 mm), (1,6; 2; 2,7; 3; 3,1 ml)
[100]	*	Sarstedt S-Monovette® (11 x 92 mm), (4,5; 5 ml)
[100]	*	7 ml probówka szklana (12 x 100 mm) 7 ml glass tube (12 x 100 mm)
[100]	*	5 ml probówka szklana (12 x 75 mm) 5 ml glass tube (12 x 75 mm)
[100]	*	5 ml probówka z korkiem (12 x 85 mm), Sarstedt® 5 ml tube with cap (12 x 85 mm), Sarstedt®
[100]	*	6 ml probówka z pokrywką (11,5 x 92 mm), Sarstedt® 6 ml tube with cap (11,5 x 92 mm), Sarstedt®
<b>14863</b>		
[96]	*	BD Vacutainer® (13 x 75 mm), (1,6-5,3 ml)
[96]	*	BD Vacutainer® (13 x 100 mm), (4-7 ml)
[96]	*	Greiner Vacuette® (13 x 75 mm), (1-4,5 ml)
[96]	*	Greiner Vacuette® (13 x 100 mm), (3,5-6 ml)
[96]	*	Sarstedt S-Monovette® (13 x 75 mm), (2,7; 3; 4,3 ml)
[96]	*	Sarstedt S-Monovette® (11 x 92 mm), (4,5; 5 ml)
[96]	*	Sarstedt S-Monovette® (13 x 65 mm), (2,6; 2,9; 3,4; 3,8 ml)
[96]	*	Sarstedt S-Monovette® (13 x 90 mm), (4,9; 5,6 ml)
[96]	*	5 ml probówka szklana (12 x 75 mm) 5 ml glass tube (12 x 75 mm)
[96]	*	5 ml probówka z korkiem (12 x 85 mm), Sarstedt® 5 ml tube with cap (12 x 85 mm), Sarstedt®
[96]	*	6 ml probówka z pokrywką (11,5 x 92 mm), Sarstedt® 6 ml tube with cap (11,5 x 92 mm), Sarstedt®
<b>14842+14017</b>		
[4]	*	250 ml butelka okrągłodenna (62 x 122 mm), Herolab® nr 25 34 43 250 ml round-bottom bottle (62 x 122 mm), Herolab® no. 25 34 43
<b>14842+14175</b>		
[4]	15175	250 ml butelka płaskodenna (62 x 122 mm), Herolab® nr 25 34 21 250 ml bottle, flat bottom (62 x 122 mm), Herolab® no. 25 34 21
[4]	15176	250 ml butelka płaskodenna (62 x 122 mm), Herolab® nr 25 34 01 250 ml bottle, flat bottom (62 x 122 mm), Herolab® no. 25 34 01
<b>13833+17834</b>		
<b>14851+14175</b>		
[4]	15175	250 ml butelka płaskodenna (62 x 122 mm), Herolab® nr 25 34 21 250 ml bottle, flat bottom (62 x 122 mm), Herolab® no. 25 34 21
[4]	15176	250 ml butelka płaskodenna (62 x 122 mm), Herolab® nr 25 34 01 250 ml bottle, flat bottom (62 x 122 mm), Herolab® no. 25 34 01
<b>13833 R max 184 RCF 3291</b>		
<b>14845 Rmax 184 RCF 3291</b>		
[72]	*	BD Vacutainer® (13 x 75 mm), (1,6-5,3 ml)
[72]	*	BD Vacutainer® (13 x 100 mm), (4-7 ml)
[72]	*	Greiner Vacuette® (13 x 75 mm), (1-4,5 ml)
[72]	*	Greiner Vacuette® (13 x 100 mm), (3,5-6 ml)
[72]	*	Sarstedt S-Monovette® (11 x 66 mm), (1,6; 2; 2,7; 3; 3,1 ml)
[72]	*	Sarstedt S-Monovette® (13 x 65 mm), (2,6; 2,9; 3,4; 3,8 ml)

\* probówka niedostępna w ofercie MPW lub dostępny odpowiednik (np.[15050]), patrz kolumna z prawej  
tube is not offered by MPW or equivalent is available (e.g. [15050]), see column on the right

**A. Wyposażenie dodatkowe/Optional accessories**
**MPW-380/R**

[72]	*	Sarstedt S-Monovette® (13 x 75 mm), (2,7; 3; 4,3 ml)
[72]	*	Sarstedt S-Monovette® (11 x 92 mm), (4,5; 5 ml)
[72]	*	Sarstedt S-Monovette® (13 x 90 mm), (4,9; 5,6 ml)
[72]	*	5 ml probówka szklana (12 x 75 mm) 5 ml glass tube (12 x 75 mm)
[72]	*	5 ml probówka z korkiem (12 x 85 mm), Sarstedt® 5 ml tube with cap (12 x 85 mm), Sarstedt®
[72]	*	7 ml probówka szklana (12 x 100 mm) 7 ml glass tube (12 x 100 mm)
[72]	*	6 ml probówka z pokrywką (11,5 x 92 mm), Sarstedt® 6 ml tube with cap (11,5 x 92 mm), Sarstedt®
		<b>14846 Rmax 184 RCF 3291</b>
[48]	15046	14 ml probówka z pokrywką (16,8 x 113,7 mm), Sarstedt® 14 ml tube with cap (16,8 x 113,7 mm), Sarstedt®
[48]	15053	10 ml probówka z pokrywką (16 x 106 mm) 10 ml tube with cap (16 x 106 mm)
[48]	*	BD Vacutainer® (16 x 100 mm), (2,5-11 ml)
[48]	*	Greiner Vacuette® (16 x 100 mm), (7-9 ml)
[48]	*	Sarstedt S-Monovette® (15 x 92 mm), (7,5; 8,2; 8,5 ml)
[48]	*	10 ml Thermo Nalgene® Oak Ridge (16 x 81,5 mm)
[48]	15118	10 ml probówka szklana (16 x 100 mm) 10 ml glass tube (16 x 100 mm)
		<b>14848 Rmax 184 RCF 3291</b>
[20]	15055	30 ml probówka z pokrywką (25,4 x 103,2 mm) 30 ml tube with cap (25,4 x 103,2 mm)
[20]	*	28 ml Thermo Nalgene® Oak Ridge (25,4 x 101,8 mm)
[20]	*	30 ml Thermo Nalgene® Oak Ridge (25,5 x 94,3 mm) 30 ml Thermo Nalgene® Oak Ridge (25,5 x 94,3 mm)
[20]	*	25 ml probówka szklana (25 x 100 mm) 25 ml glass tube (25 x 100 mm)
		<b>14849 Rmax 184 RCF 3291</b>
[16]	*	50 ml probówka z dnem stożkowym z zakrętką (30 x 117 mm), Falcon®; [15052] 50ml (30 x 117mm) 50 ml tube, conical bottom, with cap (30 x 117 mm), Falcon®; [15052] 50ml Sarstedt® (30 x 117 mm)
[16]	*	50 ml probówka z dnem stożkowym bez rantu (30 x 115 mm), Greiner® 50 ml tube, conical bottom, without skirt (30 x 115 mm), Greiner®
		<b>14850 Rmax 184 RCF 3291</b>
[4]	15040	100 ml probówka z pokrywką (45,2 x 103,7 mm) 100 ml tube with cap (45,2 x 103,7 mm)
[4]	*	100 ml probówka szklana (44 x 100 mm) 100 ml glass tube (44 x 100 mm)
		<b>14853 Rmax 184 RCF 3291</b>
[84]	*	2-1,5 ml probówka (10,8x41,8 mm), Eppendorf®; [15011], 2 ml (10,8x41,8 mm); [15128], 1,5ml (10,8x40,5 mm)
[84]	*	2 ml probówki z filtrem - spin columns (10,8 x 46 mm) 2 ml spin columns (with filter) (10,8 x 46 mm); [15011], 2 ml (10,8x41,8 mm); [15128], 1,5ml
		<b>14854 Rmax 184 RCF 3291</b>
[4]	15440	200 ml butelka płaskodenna (56 x 112 mm), Herolab® nr 25 33 73 200 ml bottle, flat bottom (56 x 112 mm), Herolab® no. 25 33 73
		<b>14861 Rmax 184 RCF 3291</b>
[96]	*	Sarstedt S-Monovette® (8 x 66 mm), (1,1; 1,2; 1,4 ml) Sarstedt S-Monovette® (8 x 66 mm), (1,1; 1,2; 1,4 ml)
		<b>14867 Rmax 184 RCF 3291</b>
[36]	*	15 ml probówka z dnem stożkowym z zakrętką (17 x 120 mm), Falcon®; [15050], 15ml (17 x 120 mm) 15 ml tube, conical bottom, with cap (17 x 120 mm), Falcon®; [15050] 15ml Sarstedt®(17 x 120 mm) <b>bez wkładki/without adapter Rmax 184 RCF 3291</b>
[4]	15852	500 ml butelka (84 x 135 mm), Herolab® nr 25 36 11 500 ml bottle (84 x 135 mm), Herolab® no. 25 36 11
		<b>14851+14017 Rmax 184 RCF 3291</b>
[4]	*	250 ml butelka okrągłodenna (62 x 122 mm), Herolab® nr 25 34 43 250 ml round-bottom bottle (62 x 122 mm), Herolab® no. 25 34 43
		<b>14851+14175 Rmax 184 RCF 3291</b>
[4]	15175	250 ml butelka płaskodenna (62 x 122 mm), Herolab® nr 25 34 21 250 ml bottle, flat bottom (62 x 122 mm), Herolab® no. 25 34 21
[4]	15176	250 ml butelka płaskodenna (62 x 122 mm), Herolab® nr 25 34 01 250 ml bottle, flat bottom (62 x 122 mm), Herolab® no. 25 34 01
		<b>14847 Rmax 184 RCF 3291</b>
[48]	15050	15 ml probówka z dnem stożkowym z zakrętką (17 x 120 mm), Sarstedt® 15 ml tube, conical bottom, with cap (17 x 120 mm), Sarstedt®
		<b>14859 Rmax 184 RCF 3291</b>
[12]	*	50 ml probówka szklana (35 x 100 mm) 50 ml glass tube (35 x 100 mm)
		<b>14850+14159 Rmax 184 RCF 3291</b>
[4]	*	50 ml probówka szklana (35 x 100 mm) 50 ml glass tube (35 x 100 mm)
		<b>13865 R max 183 RCF 3274</b>
		<b>14043 Rmax 183 RCF 3274</b>

\* probówka niedostępna w ofercie MPW lub dostępny odpowiednik (np.[15050]), patrz kolumna z prawej  
tube is not offered by MPW or equivalent is available (e.g. [15050]), see column on the right

**A. Wyposażenie dodatkowe/Optional accessories**
**MPW-380/R**

[28]	*	Greiner Vacuette® (13 x 75 mm), (1-4,5 ml)
[28]	*	5 ml probówka szklana (12 x 75 mm) 5 ml glass tube (12 x 75 mm)
[28]	*	5 ml probówka z korkiem (12 x 85 mm), Sarstedt® 5 ml tube with cap (12 x 85 mm), Sarstedt®
		<b>14071 Rmax 183 RCF 3274</b>
[28]	15055	30 ml probówka z pokrywką (25,4 x 103,2 mm) 30 ml tube with cap (25,4 x 103,2 mm)
[28]	*	28 ml Thermo Nalgene® Oak Ridge (25,4 x 101,8 mm)
[28]	*	30 ml probówka z pokrywką (25,5 x 94 mm), Nalgene® 30 ml tube with cap (25,5 x 94 mm), Nalgene®
[28]	*	30 ml Thermo Nalgene® Oak Ridge (25,5 x 94,3 mm) 30 ml Thermo Nalgene® Oak Ridge (25,5 x 94,3 mm)
[28]	*	25 ml probówka szklana (25 x 100 mm) 25 ml glass tube (25 x 100 mm)
		<b>14073 Rmax 183 RCF 3274</b>
[28]	15053	10 ml probówka z pokrywką (16 x 106 mm) 10 ml tube with cap (16 x 106 mm)
[28]	*	BD Vacutainer® (16 x 100 mm), (2,5-11 ml)
[28]	*	Greiner Vacuette® (16 x 100 mm), (7-9 ml)
[28]	*	Sarstedt S-Monovette® (15 x 92 mm), (7,5; 8,2; 8,5 ml)
[28]	15046	14 ml probówka z pokrywką (16,8 x 113,7 mm), Sarstedt® 14 ml tube with cap (16,8 x 113,7 mm), Sarstedt®
[28]	*	Sarstedt S-Monovette® (16 x 92 mm), (9; 10 ml)
[28]	15118	10 ml probówka szklana (16 x 100 mm) 10 ml glass tube (16 x 100 mm)
[28]	*	15 ml Thermo Nalgene® (16 x 113 mm) 15 ml Thermo Nalgene® (16 x 113 mm)
		<b>14089 Rmax 183 RCF 3274</b>
[4]	*	15 ml probówka z dnem stożkowym z zakrętką (17 x 120 mm), Falcon®; [15050], 15ml (17 x 120 mm) 15 ml tube, conical bottom, with cap (17 x 120 mm), Falcon®; [15050] 15ml Sarstedt®(17 x 120 mm) <b>bez wkładki/without adapter Rmax 183 RCF 3274</b>
[28]	*	50 ml probówka z dnem stożkowym z zakrętką (30 x 117 mm), Falcon®; [15052] 50ml (30 x 117mm) 50 ml tube, conical bottom, with cap (30 x 117 mm), Falcon®; [15052] 50ml Sarstedt® (30 x 117 mm)
[28]	*	50 ml probówka z dnem stożkowym bez rantu (30 x 115 mm), Greiner® 50 ml tube, conical bottom, without skirt (30 x 115 mm), Greiner®
		<b>13866 R max 186 RCF 3327</b>
		<b>14043 Rmax 186 RCF 3327</b>
[24]	*	Greiner Vacuette® (13 x 75 mm), (1-4,5 ml)
[24]	*	5 ml probówka szklana (12 x 75 mm) 5 ml glass tube (12 x 75 mm)
[24]	*	5 ml probówka z korkiem (12 x 85 mm), Sarstedt® 5 ml tube with cap (12 x 85 mm), Sarstedt®
		<b>14071 Rmax 186 RCF 3327</b>
[24]	15055	30 ml probówka z pokrywką (25,4 x 103,2 mm) 30 ml tube with cap (25,4 x 103,2 mm)
[24]	*	28 ml Thermo Nalgene® Oak Ridge (25,4 x 101,8 mm)
[24]	*	30 ml probówka z pokrywką (25,5 x 94 mm), Nalgene® 30 ml tube with cap (25,5 x 94 mm), Nalgene®
[24]	*	30 ml Thermo Nalgene® Oak Ridge (25,5 x 94,3 mm) 30 ml Thermo Nalgene® Oak Ridge (25,5 x 94,3 mm)
[24]	*	25 ml probówka szklana (25 x 100 mm) 25 ml glass tube (25 x 100 mm)
		<b>14073 Rmax 186 RCF 3327</b>
[24]	15046	14 ml probówka z pokrywką (16,8 x 113,7 mm), Sarstedt® 14 ml tube with cap (16,8 x 113,7 mm), Sarstedt®
[24]	15053	10 ml probówka z pokrywką (16 x 106 mm) 10 ml tube with cap (16 x 106 mm)
[24]	*	BD Vacutainer® (16 x 100 mm), (2,5-11 ml)
[24]	*	Greiner Vacuette® (16 x 100 mm), (7-9 ml)
[24]	*	Sarstedt S-Monovette® (15 x 92 mm), (7,5; 8,2; 8,5 ml)
[24]	*	Sarstedt S-Monovette® (16 x 92 mm), (9; 10 ml)
[24]	15118	10 ml probówka szklana (16 x 100 mm) 10 ml glass tube (16 x 100 mm)
[24]	*	15 ml Thermo Nalgene® (16 x 113 mm) 15 ml Thermo Nalgene® (16 x 113 mm)
		<b>14089 Rmax 186 RCF 3327</b>
[4]	*	15 ml probówka z dnem stożkowym z zakrętką (17 x 120 mm), Falcon®; [15050], 15ml (17 x 120 mm) 15 ml tube, conical bottom, with cap (17 x 120 mm), Falcon®; [15050] 15ml Sarstedt®(17 x 120 mm) <b>bez wkładki/without adapter Rmax 186 RCF 3327</b>
[24]	*	50 ml probówka z dnem stożkowym z zakrętką (30 x 117 mm), Falcon®; [15052] 50ml (30 x 117mm) 50 ml tube, conical bottom, with cap (30 x 117 mm), Falcon®; [15052] 50ml Sarstedt® (30 x 117 mm)
[24]	*	50 ml probówka z dnem stożkowym bez rantu (30 x 115 mm), Greiner® 50 ml tube, conical bottom, without skirt (30 x 115 mm), Greiner®
		<b>13833+17834 R max 184 RCF 3291</b>

\* probówka niedostępna w ofercie MPW lub dostępny odpowiednik (np.[15050]), patrz kolumna z prawej  
tube is not offered by MPW or equivalent is available (e.g. [15050]), see column on the right

**A. Wyposażenie dodatkowe/Optional accessories**
**MPW-380/R**

		<b>14845 Rmax 184 RCF 3291</b>
[72]	*	BD Vacutainer® (13 x 75 mm), (1,6-5,3 ml)
[72]	*	BD Vacutainer® (13 x 100 mm), (4-7 ml)
[72]	*	Greiner Vacuette® (13 x 75 mm), (1-4,5 ml)
[72]	*	Greiner Vacuette® (13 x 100 mm), (3,5-6 ml)
[72]	*	Sarstedt S-Monovette® (11 x 66 mm), (1,6; 2; 2,7; 3; 3,1 ml)
[72]	*	Sarstedt S-Monovette® (13 x 65 mm), (2,6; 2,9; 3,4; 3,8 ml)
[72]	*	Sarstedt S-Monovette® (13 x 75 mm), (2,7; 3; 4,3 ml)
[72]	*	Sarstedt S-Monovette® (11 x 92 mm), (4,5; 5 ml)
[72]	*	Sarstedt S-Monovette® (13 x 90 mm), (4,9; 5,6 ml)
[72]	*	5 ml probówka szklana (12 x 75 mm)
		5 ml glass tube (12 x 75 mm)
[72]	*	5 ml probówka z korkiem (12 x 85 mm), Sarstedt®
		5 ml tube with cap (12 x 85 mm), Sarstedt®
[72]	*	7 ml probówka szklana (12 x 100 mm)
		7 ml glass tube (12 x 100 mm)
[72]	*	6 ml probówka z pokrywką (11,5 x 92 mm), Sarstedt®
		6 ml tube with cap (11,5 x 92 mm), Sarstedt®
		<b>14846 Rmax 184 RCF 3291</b>
[48]	15046	14 ml probówka z pokrywką (16,8 x 113,7 mm), Sarstedt®
		14 ml tube with cap (16,8 x 113,7 mm), Sarstedt®
[48]	15053	10 ml probówka z pokrywką (16 x 106 mm)
		10 ml tube with cap (16 x 106 mm)
[48]	*	BD Vacutainer® (16 x 100 mm), (2,5-11 ml)
[48]	*	Greiner Vacuette® (16 x 100 mm), (7-9 ml)
[48]	*	Sarstedt S-Monovette® (15 x 92 mm), (7,5; 8,2; 8,5 ml)
[48]	*	10 ml Thermo Nalgene® Oak Ridge (16 x 81,5 mm)
[48]	15118	10 ml probówka szklana (16 x 100 mm)
		10 ml glass tube (16 x 100 mm)
		<b>14848 Rmax 184 RCF 3291</b>
[20]	15055	30 ml probówka z pokrywką (25,4 x 103,2 mm)
		30 ml tube with cap (25,4 x 103,2 mm)
[20]	*	28 ml Thermo Nalgene® Oak Ridge (25,4 x 101,8 mm)
[20]	*	30 ml Thermo Nalgene® Oak Ridge (25,5 x 94,3 mm)
		30 ml Thermo Nalgene® Oak Ridge (25,5 x 94,3 mm)
[20]	*	25 ml probówka szklana (25 x 100 mm)
		25 ml glass tube (25 x 100 mm)
		<b>14849 Rmax 184 RCF 3291</b>
[16]	*	50 ml probówka z dnem stożkowym z zakrętką (30 x 117 mm), Falcon®; [15052] 50ml (30 x 117mm)
		50 ml tube, conical bottom, with cap (30 x 117 mm), Falcon®; [15052] 50ml Sarstedt® (30 x 117 mm)
[16]	*	50 ml probówka z dnem stożkowym bez rantu (30 x 115 mm), Greiner®
		50 ml tube, conical bottom, without skirt (30 x 115 mm), Greiner®
		<b>14850 Rmax 184 RCF 3291</b>
[4]	15040	100 ml probówka z pokrywką (45,2 x 103,7 mm)
		100 ml tube with cap (45,2 x 103,7 mm)
[4]	*	100 ml probówka szklana (44 x 100 mm)
		100 ml glass tube (44 x 100 mm)
		<b>14853 Rmax 184 RCF 3291</b>
[84]	*	2-1,5 ml probówka (10,8x41,8 mm), Eppendorf®; [15011], 2 ml (10,8x41,8 mm); [15128], 1,5ml (10,8x40,5 mm)
[84]	*	2 ml probówki z filtrem - spin columns (10,8 x 46 mm)
		2 ml spin columns (with filter) (10,8 x 46 mm); [15011], 2 ml (10,8x41,8 mm); [15128], 1,5ml
		<b>14854 Rmax 184 RCF 3291</b>
[4]	15440	200 ml butelka płaskodenna (56 x 112 mm), Herolab® nr 25 33 73
		200 ml bottle, flat bottom (56 x 112 mm), Herolab® no. 25 33 73
		<b>14861 Rmax 184 RCF 3291</b>
[96]	*	Sarstedt S-Monovette® (8 x 66 mm), (1,1; 1,2; 1,4 ml)
		Sarstedt S-Monovette® (8 x 66 mm), (1,1; 1,2; 1,4 ml)
		<b>14867 Rmax 184 RCF 3291</b>
[36]	*	15 ml probówka z dnem stożkowym z zakrętką (17 x 120 mm), Falcon®; [15050], 15ml (17 x 120 mm)
		15 ml tube, conical bottom, with cap (17 x 120 mm), Falcon®; [15050] 15ml Sarstedt®(17 x 120 mm)
		<b>bez wkładki/without adapter Rmax 184 RCF 3291</b>
[4]	15852	500 ml butelka (84 x 135 mm), Herolab® nr 25 36 11
		500 ml bottle (84 x 135 mm), Herolab® no. 25 36 11
		<b>14851+14017 Rmax 184 RCF 3291</b>
[4]	*	250 ml butelka okrągłodenna (62 x 122 mm), Herolab® nr 25 34 43
		250 ml round-bottom bottle (62 x 122 mm), Herolab® no. 25 34 43
		<b>14847 Rmax 184 RCF 3291</b>
[48]	15050	15 ml probówka z dnem stożkowym z zakrętką (17 x 120 mm), Sarstedt®
		15 ml tube, conical bottom, with cap (17 x 120 mm), Sarstedt®
		<b>14859 Rmax 184 RCF 3291</b>
[12]	*	50 ml probówka szklana (35 x 100 mm)
		50 ml glass tube (35 x 100 mm)
		<b>14850+14159 Rmax 184 RCF 3291</b>
[4]	*	50 ml probówka szklana (35 x 100 mm)
		50 ml glass tube (35 x 100 mm)

**A. Wyposażenie dodatkowe/Optional accessories**
**MPW-380/R**
**12870**
**RPM 4300 RCF 3824 Rmax 185 4 90**
**13831**
**14121**

[28] 15222 30 ml probówka z pokrywką (25 x 94mm), Sterilin®  
30 ml tube with cap (25 x 94 mm), Sterilin®

[28] 15223 30 ml probówka z pokrywką (25 x 94 mm), Sterilin®  
30 ml tube with cap (25 x 94 mm), Sterilin®

**14837**

[64] 15046 14 ml probówka z pokrywką (16,8 x 113,7 mm), Sarstedt®  
14 ml tube with cap (16,8 x 113,7 mm), Sarstedt®

[64] 15053 10 ml probówka z pokrywką (16 x 106 mm)  
10 ml tube with cap (16 x 106 mm)

[64] \* BD Vacutainer® (16 x 100 mm), (2,5-11 ml)

[64] \* Greiner Vacuette® (16 x 100 mm), (7-9 ml)

[64] \* Sarstedt S-Monovette® (15 x 75 mm), (4; 4,3; 5,5 ml)

[64] \* Sarstedt S-Monovette® (15 x 92 mm), (7,5; 8,2; 8,5 ml)

[64] \* Sarstedt S-Monovette® (16 x 92 mm), (9; 10 ml)

[64] \* 10 ml Thermo Nalgene® Oak Ridge (16 x 81,5 mm)

[64] 15118 10 ml probówka szklana (16 x 100 mm)  
10 ml glass tube (16 x 100 mm)

[64] \* 15 ml Thermo Nalgene® (16 x 113 mm)  
15 ml Thermo Nalgene® (16 x 113 mm)

**14838**

[48] \* 15 ml probówka z dnem stożkowym z zakrętką (17 x 120 mm), Falcon®; [15050], 15ml (17 x 120 mm)  
15 ml tube, conical bottom, with cap (17 x 120 mm), Falcon®; [15050] 15ml Sarstedt®(17 x 120 mm)

**14839**

[32] 15055 30 ml probówka z pokrywką (25,4 x 103,2 mm)  
30 ml tube with cap (25,4 x 103,2 mm)

[32] \* 28 ml Thermo Nalgene® Oak Ridge (25,4 x 101,8 mm)

[32] \* 30 ml probówka z pokrywką (25,5 x 94 mm), Nalgene®  
30 ml tube with cap (25,5 x 94 mm), Nalgene®

[32] \* 30 ml Thermo Nalgene® Oak Ridge (25,5 x 94,3 mm)  
30 ml Thermo Nalgene® Oak Ridge (25,5 x 94,3 mm)

[32] \* 25 ml probówka szklana (25 x 100 mm)  
25 ml glass tube (25 x 100 mm)

**14840**

[20] \* 50 ml probówka z dnem stożkowym z zakrętką (30 x 117 mm), Falcon®; [15052] 50ml (30 x 117mm)  
50 ml tube, conical bottom, with cap (30 x 117 mm), Falcon®; [15052] 50ml Sarstedt® (30 x 117 mm)

[20] \* 50 ml probówka z dnem stożkowym bez rantu (30 x 115 mm), Greiner®  
50 ml tube, conical bottom, without skirt (30 x 115 mm), Greiner®

**14841**

[8] 15040 100 ml probówka z pokrywką (45,2 x 103,7 mm)  
100 ml tube with cap (45,2 x 103,7 mm)

[8] \* 100 ml probówka szklana (44 x 100 mm)  
100 ml glass tube (44 x 100 mm)

**14844**

[104] \* 2-1,5 ml probówka (10,8x41,8 mm), Eppendorf®; [15011], 2 ml (10,8x41,8 mm); [15128], 1,5ml (10,8x40,5 mm)

[104] \* 2 ml probówki z filtrem - spin columns (10,8 x 46 mm)  
2 ml spin columns (with filter) (10,8 x 46 mm); [15011], 2 ml (10,8x41,8 mm); [15128], 1,5ml

**14860**

[112] \* Sarstedt S-Monovette® (8 x 66 mm), (1,1; 1,2; 1,4 ml)  
Sarstedt S-Monovette® (8 x 66 mm), (1,1; 1,2; 1,4 ml)

**14862**

[100] \* Sarstedt S-Monovette® (11 x 66 mm), (1,6; 2; 2,7; 3; 3,1 ml)

[100] \* Sarstedt S-Monovette® (11 x 92 mm), (4,5; 5 ml)

[100] \* 7 ml probówka szklana (12 x 100 mm)  
7 ml glass tube (12 x 100 mm)

[100] \* 5 ml probówka szklana (12 x 75 mm)  
5 ml glass tube (12 x 75 mm)

[100] \* 5 ml probówka z korkiem (12 x 85 mm), Sarstedt®  
5 ml tube with cap (12 x 85 mm), Sarstedt®

[100] \* 6 ml probówka z pokrywką (11,5 x 92 mm), Sarstedt®  
6 ml tube with cap (11,5 x 92 mm), Sarstedt®

**14863**

[96] \* BD Vacutainer® (13 x 75 mm), (1,6-5,3 ml)

[96] \* BD Vacutainer® (13 x 100 mm), (4-7 ml)

[96] \* Greiner Vacuette® (13 x 75 mm), (1-4,5 ml)

[96] \* Greiner Vacuette® (13 x 100 mm), (3,5-6 ml)

[96] \* Sarstedt S-Monovette® (13 x 75 mm), (2,7; 3; 4,3 ml)

[96] \* Sarstedt S-Monovette® (11 x 92 mm), (4,5; 5 ml)

[96] \* Sarstedt S-Monovette® (13 x 65 mm), (2,6; 2,9; 3,4; 3,8 ml)

[96] \* Sarstedt S-Monovette® (13 x 90 mm), (4,9; 5,6 ml)

[96] \* 5 ml probówka szklana (12 x 75 mm)  
5 ml glass tube (12 x 75 mm)

\* probówka niedostępna w ofercie MPW lub dostępny odpowiednik (np.[15050]), patrz kolumna z prawej  
tube is not offered by MPW or equivalent is available (e.g. [15050]), see column on the right



**A. Wyposażenie dodatkowe/Optional accessories**
**MPW-380/R**

[96]	*	5 ml probówka z korkiem (12 x 85 mm), Sarstedt® 5 ml tube with cap (12 x 85 mm), Sarstedt®
[96]	*	6 ml probówka z pokrywką (11,5 x 92 mm), Sarstedt® 6 ml tube with cap (11,5 x 92 mm), Sarstedt®
<b>14842+14017</b>		
[4]	*	250 ml butelka okrągłodenna (62 x 122 mm), Herolab® nr 25 34 43 250 ml round-bottom bottle (62 x 122 mm), Herolab® no. 25 34 43
<b>14842+14175</b>		
[4]	15175	250 ml butelka płaskodenna (62 x 122 mm), Herolab® nr 25 34 21 250 ml bottle, flat bottom (62 x 122 mm), Herolab® no. 25 34 21
[4]	15176	250 ml butelka płaskodenna (62 x 122 mm), Herolab® nr 25 34 01 250 ml bottle, flat bottom (62 x 122 mm), Herolab® no. 25 34 01
<b>13831+17832</b>		
<b>14121</b>		
[28]	15222	30 ml probówka z pokrywką (25 x 94mm), Sterilin® 30 ml tube with cap (25 x 94 mm), Sterilin®
[28]	15223	30 ml probówka z pokrywką (25 x 94 mm), Sterilin® 30 ml tube with cap (25 x 94 mm), Sterilin®
<b>14837</b>		
[64]	15046	14 ml probówka z pokrywką (16,8 x 113,7 mm), Sarstedt® 14 ml tube with cap (16,8 x 113,7 mm), Sarstedt®
[64]	15053	10 ml probówka z pokrywką (16 x 106 mm) 10 ml tube with cap (16 x 106 mm)
[64]	*	BD Vacutainer® (16 x 100 mm), (2,5-11 ml)
[64]	*	Greiner Vacuette® (16 x 100 mm), (7-9 ml)
[64]	*	Sarstedt S-Monovette® (15 x 75 mm), (4; 4,3; 5,5 ml)
[64]	*	Sarstedt S-Monovette® (15 x 92 mm), (7,5; 8,2; 8,5 ml)
[64]	*	Sarstedt S-Monovette® (16 x 92 mm), (9; 10 ml)
[64]	*	10 ml Thermo Nalgene® Oak Ridge (16 x 81,5 mm)
[64]	15118	10 ml probówka szklana (16 x 100 mm) 10 ml glass tube (16 x 100 mm)
[64]	*	15 ml Thermo Nalgene® (16 x 113 mm) 15 ml Thermo Nalgene® (16 x 113 mm)
<b>14838</b>		
[48]	*	15 ml probówka z dnem stożkowym z zakrętką (17 x 120 mm), Falcon®; [15050], 15ml (17 x 120 mm) 15 ml tube, conical bottom, with cap (17 x 120 mm), Falcon®; [15050] 15ml Sarstedt®(17 x 120 mm)
<b>14839</b>		
[32]	15055	30 ml probówka z pokrywką (25,4 x 103,2 mm) 30 ml tube with cap (25,4 x 103,2 mm)
[32]	*	28 ml Thermo Nalgene® Oak Ridge (25,4 x 101,8 mm)
[32]	*	30 ml probówka z pokrywką (25,5 x 94 mm), Nalgene® 30 ml tube with cap (25,5 x 94 mm), Nalgene®
[32]	*	30 ml Thermo Nalgene® Oak Ridge (25,5 x 94,3 mm) 30 ml Thermo Nalgene® Oak Ridge (25,5 x 94,3 mm)
[32]	*	25 ml probówka szklana (25 x 100 mm) 25 ml glass tube (25 x 100 mm)
<b>14840</b>		
[20]	*	50 ml probówka z dnem stożkowym z zakrętką (30 x 117 mm), Falcon®; [15052] 50ml (30 x 117mm) 50 ml tube, conical bottom, with cap (30 x 117 mm), Falcon®; [15052] 50ml Sarstedt® (30 x 117 mm)
[20]	*	50 ml probówka z dnem stożkowym bez rantu (30 x 115 mm), Greiner® 50 ml tube, conical bottom, without skirt (30 x 115 mm), Greiner®
<b>14841</b>		
[8]	15040	100 ml probówka z pokrywką (45,2 x 103,7 mm) 100 ml tube with cap (45,2 x 103,7 mm)
[8]	*	100 ml probówka szklana (44 x 100 mm) 100 ml glass tube (44 x 100 mm)
<b>14844</b>		
[104]	*	2-1,5 ml probówka (10,8x41,8 mm), Eppendorf®; [15011], 2 ml (10,8x41,8 mm); [15128], 1,5ml (10,8x40,5 mm)
[104]	*	2 ml probówki z filtrem - spin columns (10,8 x 46 mm) 2 ml spin columns (with filter) (10,8 x 46 mm); [15011], 2 ml (10,8x41,8 mm); [15128], 1,5ml
<b>14860</b>		
[112]	*	Sarstedt S-Monovette® (8 x 66 mm), (1,1; 1,2; 1,4 ml) Sarstedt S-Monovette® (8 x 66 mm), (1,1; 1,2; 1,4 ml)
<b>14862</b>		
[100]	*	Sarstedt S-Monovette® (11 x 66 mm), (1,6; 2; 2,7; 3; 3,1 ml)
[100]	*	Sarstedt S-Monovette® (11 x 92 mm), (4,5; 5 ml)
[100]	*	7 ml probówka szklana (12 x 100 mm) 7 ml glass tube (12 x 100 mm)
[100]	*	5 ml probówka szklana (12 x 75 mm) 5 ml glass tube (12 x 75 mm)
[100]	*	5 ml probówka z korkiem (12 x 85 mm), Sarstedt® 5 ml tube with cap (12 x 85 mm), Sarstedt®
[100]	*	6 ml probówka z pokrywką (11,5 x 92 mm), Sarstedt® 6 ml tube with cap (11,5 x 92 mm), Sarstedt®
<b>14863</b>		

\* probówka niedostępna w ofercie MPW lub dostępny odpowiednik (np.[15050]), patrz kolumna z prawej  
tube is not offered by MPW or equivalent is available (e.g. [15050]), see column on the right

**A. Wyposażenie dodatkowe/Optional accessories**
**MPW-380/R**

[96]	*	BD Vacutainer® (13 x 75 mm), (1,6-5,3 ml)
[96]	*	BD Vacutainer® (13 x 100 mm), (4-7 ml)
[96]	*	Greiner Vacuette® (13 x 75 mm), (1-4,5 ml)
[96]	*	Greiner Vacuette® (13 x 100 mm), (3,5-6 ml)
[96]	*	Sarstedt S-Monovette® (13 x 75 mm), (2,7; 3; 4,3 ml)
[96]	*	Sarstedt S-Monovette® (11 x 92 mm), (4,5; 5 ml)
[96]	*	Sarstedt S-Monovette® (13 x 65 mm), (2,6; 2,9; 3,4; 3,8 ml)
[96]	*	Sarstedt S-Monovette® (13 x 90 mm), (4,9; 5,6 ml)
[96]	*	5 ml probówka szklana (12 x 75 mm) 5 ml glass tube (12 x 75 mm)
[96]	*	5 ml probówka z korkiem (12 x 85 mm), Sarstedt® 5 ml tube with cap (12 x 85 mm), Sarstedt®
[96]	*	6 ml probówka z pokrywką (11,5 x 92 mm), Sarstedt® 6 ml tube with cap (11,5 x 92 mm), Sarstedt®
<b>14842+14017</b>		
[4]	*	250 ml butelka okrągłodenna (62 x 122 mm), Herolab® nr 25 34 43 250 ml round-bottom bottle (62 x 122 mm), Herolab® no. 25 34 43
<b>14842+14175</b>		
[4]	15175	250 ml butelka płaskodenna (62 x 122 mm), Herolab® nr 25 34 21 250 ml bottle, flat bottom (62 x 122 mm), Herolab® no. 25 34 21
[4]	15176	250 ml butelka płaskodenna (62 x 122 mm), Herolab® nr 25 34 01 250 ml bottle, flat bottom (62 x 122 mm), Herolab® no. 25 34 01
<b>13833+17834</b>		
<b>14851+14175</b>		
[4]	15175	250 ml butelka płaskodenna (62 x 122 mm), Herolab® nr 25 34 21 250 ml bottle, flat bottom (62 x 122 mm), Herolab® no. 25 34 21
[4]	15176	250 ml butelka płaskodenna (62 x 122 mm), Herolab® nr 25 34 01 250 ml bottle, flat bottom (62 x 122 mm), Herolab® no. 25 34 01
<b>13833 R max 184 RCF 3804</b>		
<b>14845 Rmax 184 RCF 3804</b>		
[72]	*	BD Vacutainer® (13 x 75 mm), (1,6-5,3 ml)
[72]	*	BD Vacutainer® (13 x 100 mm), (4-7 ml)
[72]	*	Greiner Vacuette® (13 x 75 mm), (1-4,5 ml)
[72]	*	Greiner Vacuette® (13 x 100 mm), (3,5-6 ml)
[72]	*	Sarstedt S-Monovette® (11 x 66 mm), (1,6; 2; 2,7; 3; 3,1 ml)
[72]	*	Sarstedt S-Monovette® (13 x 65 mm), (2,6; 2,9; 3,4; 3,8 ml)
[72]	*	Sarstedt S-Monovette® (13 x 75 mm), (2,7; 3; 4,3 ml)
[72]	*	Sarstedt S-Monovette® (11 x 92 mm), (4,5; 5 ml)
[72]	*	Sarstedt S-Monovette® (13 x 90 mm), (4,9; 5,6 ml)
[72]	*	5 ml probówka szklana (12 x 75 mm) 5 ml glass tube (12 x 75 mm)
[72]	*	5 ml probówka z korkiem (12 x 85 mm), Sarstedt® 5 ml tube with cap (12 x 85 mm), Sarstedt®
[72]	*	7 ml probówka szklana (12 x 100 mm) 7 ml glass tube (12 x 100 mm)
[72]	*	6 ml probówka z pokrywką (11,5 x 92 mm), Sarstedt® 6 ml tube with cap (11,5 x 92 mm), Sarstedt®
<b>14846 Rmax 184 RCF 3804</b>		
[48]	15046	14 ml probówka z pokrywką (16,8 x 113,7 mm), Sarstedt® 14 ml tube with cap (16,8 x 113,7 mm), Sarstedt®
[48]	15053	10 ml probówka z pokrywką (16 x 106 mm) 10 ml tube with cap (16 x 106 mm)
[48]	*	BD Vacutainer® (16 x 100 mm), (2,5-11 ml)
[48]	*	Greiner Vacuette® (16 x 100 mm), (7-9 ml)
[48]	*	Sarstedt S-Monovette® (15 x 92 mm), (7,5; 8,2; 8,5 ml)
[48]	*	10 ml Thermo Nalgene® Oak Ridge (16 x 81,5 mm)
[48]	15118	10 ml probówka szklana (16 x 100 mm) 10 ml glass tube (16 x 100 mm)
<b>14848 Rmax 184 RCF 3804</b>		
[20]	15055	30 ml probówka z pokrywką (25,4 x 103,2 mm) 30 ml tube with cap (25,4 x 103,2 mm)
[20]	*	28 ml Thermo Nalgene® Oak Ridge (25,4 x 101,8 mm)
[20]	*	30 ml Thermo Nalgene® Oak Ridge (25,5 x 94,3 mm) 30 ml Thermo Nalgene® Oak Ridge (25,5 x 94,3 mm)
[20]	*	25 ml probówka szklana (25 x 100 mm) 25 ml glass tube (25 x 100 mm)
<b>14849 Rmax 184 RCF 3804</b>		
[16]	*	50 ml probówka z dnem stożkowym z zakrętką (30 x 117 mm), Falcon®; [15052] 50ml (30 x 117mm) 50 ml tube, conical bottom, with cap (30 x 117 mm), Falcon®; [15052] 50ml Sarstedt® (30 x 117 mm)
[16]	*	50 ml probówka z dnem stożkowym bez rantu (30 x 115 mm), Greiner® 50 ml tube, conical bottom, without skirt (30 x 115 mm), Greiner®
<b>14850 Rmax 184 RCF 3804</b>		
[4]	15040	100 ml probówka z pokrywką (45,2 x 103,7 mm) 100 ml tube with cap (45,2 x 103,7 mm)

\* probówka niedostępna w ofercie MPW lub dostępny odpowiednik (np.[15050]), patrz kolumna z prawej  
tube is not offered by MPW or equivalent is available (e.g. [15050]), see column on the right



**A. Wyposażenie dodatkowe/Optional accessories**
**MPW-380/R**

[4]	*	100 ml probówka szklana (44 x 100 mm) 100 ml glass tube (44 x 100 mm) <b>14853 Rmax 184 RCF 3804</b>
[84]	*	2-1,5 ml probówka (10,8x41,8 mm), Eppendorf®; [15011], 2 ml (10,8x41,8 mm); [15128], 1,5ml (10,8x40,5 mm)
[84]	*	2 ml próbki z filtrem - spin columns (10,8 x 46 mm) 2 ml spin columns (with filter) (10,8 x 46 mm); [15011], 2 ml (10,8x41,8 mm); [15128], 1,5ml <b>14854 Rmax 184 RCF 3804</b>
[4]	15440	200 ml butelka płaskodenna (56 x 112 mm), Herolab® nr 25 33 73 200 ml bottle, flat bottom (56 x 112 mm), Herolab® no. 25 33 73 <b>14861 Rmax 184 RCF 3804</b>
[96]	*	Sarstedt S-Monovette® (8 x 66 mm), (1,1; 1,2; 1,4 ml) Sarstedt S-Monovette® (8 x 66 mm), (1,1; 1,2; 1,4 ml) <b>14867 Rmax 184 RCF 3804</b>
[36]	*	15 ml probówka z dnem stożkowym z zakrętką (17 x 120 mm), Falcon®; [15050], 15ml (17 x 120 mm) 15 ml tube, conical bottom, with cap (17 x 120 mm), Falcon®; [15050] 15ml Sarstedt®(17 x 120 mm) <b>bez wkładki/without adapter Rmax 184 RCF 3804</b>
[4]	15852	500 ml butelka (84 x 135 mm), Herolab® nr 25 36 11 500 ml bottle (84 x 135 mm), Herolab® no. 25 36 11 <b>14851+14017 Rmax 184 RCF 3804</b>
[4]	*	250 ml butelka okrągłodenna (62 x 122 mm), Herolab® nr 25 34 43 250 ml round-bottom bottle (62 x 122 mm), Herolab® no. 25 34 43 <b>14851+14175 Rmax 184 RCF 3804</b>
[4]	15175	250 ml butelka płaskodenna (62 x 122 mm), Herolab® nr 25 34 21 250 ml bottle, flat bottom (62 x 122 mm), Herolab® no. 25 34 21
[4]	15176	250 ml butelka płaskodenna (62 x 122 mm), Herolab® nr 25 34 01 250 ml bottle, flat bottom (62 x 122 mm), Herolab® no. 25 34 01 <b>14847 Rmax 184 RCF 3804</b>
[48]	15050	15 ml probówka z dnem stożkowym z zakrętką (17 x 120 mm), Sarstedt® 15 ml tube, conical bottom, with cap (17 x 120 mm), Sarstedt® <b>14859 Rmax 184 RCF 3804</b>
[12]	*	50 ml probówka szklana (35 x 100 mm) 50 ml glass tube (35 x 100 mm) <b>14850+14159 Rmax 184 RCF 3804</b>
[4]	*	50 ml probówka szklana (35 x 100 mm) 50 ml glass tube (35 x 100 mm) <b>13865 R max 183 RCF 3783</b> <b>14043 Rmax 183 RCF 3783</b>
[28]	*	Greiner Vacuette® (13 x 75 mm), (1-4,5 ml)
[28]	*	5 ml probówka szklana (12 x 75 mm) 5 ml glass tube (12 x 75 mm)
[28]	*	5 ml probówka z korkiem (12 x 85 mm), Sarstedt® 5 ml tube with cap (12 x 85 mm), Sarstedt® <b>14071 Rmax 183 RCF 3783</b>
[28]	15055	30 ml probówka z pokrywką (25,4 x 103,2 mm) 30 ml tube with cap (25,4 x 103,2 mm)
[28]	*	28 ml Thermo Nalgene® Oak Ridge (25,4 x 101,8 mm)
[28]	*	30 ml probówka z pokrywką (25,5 x 94 mm), Nalgene® 30 ml tube with cap (25,5 x 94 mm), Nalgene®
[28]	*	30 ml Thermo Nalgene® Oak Ridge (25,5 x 94,3 mm) 30 ml Thermo Nalgene® Oak Ridge (25,5 x 94,3 mm)
[28]	*	25 ml probówka szklana (25 x 100 mm) 25 ml glass tube (25 x 100 mm) <b>14073 Rmax 183 RCF 3783</b>
[28]	15053	10 ml probówka z pokrywką (16 x 106 mm) 10 ml tube with cap (16 x 106 mm)
[28]	*	BD Vacutainer® (16 x 100 mm), (2,5-11 ml)
[28]	*	Greiner Vacuette® (16 x 100 mm), (7-9 ml)
[28]	*	Sarstedt S-Monovette® (15 x 92 mm), (7,5; 8,2; 8,5 ml)
[28]	15046	14 ml probówka z pokrywką (16,8 x 113,7 mm), Sarstedt® 14 ml tube with cap (16,8 x 113,7 mm), Sarstedt®
[28]	*	Sarstedt S-Monovette® (16 x 92 mm), (9; 10 ml)
[28]	15118	10 ml probówka szklana (16 x 100 mm) 10 ml glass tube (16 x 100 mm)
[28]	*	15 ml Thermo Nalgene® (16 x 113 mm) 15 ml Thermo Nalgene® (16 x 113 mm) <b>14089 Rmax 183 RCF 3783</b>
[4]	*	15 ml probówka z dnem stożkowym z zakrętką (17 x 120 mm), Falcon®; [15050], 15ml (17 x 120 mm) 15 ml tube, conical bottom, with cap (17 x 120 mm), Falcon®; [15050] 15ml Sarstedt®(17 x 120 mm) <b>bez wkładki/without adapter Rmax 183 RCF 3783</b>
[28]	*	50 ml probówka z dnem stożkowym z zakrętką (30 x 117 mm), Falcon®; [15052] 50ml (30 x 117mm) 50 ml tube, conical bottom, with cap (30 x 117 mm), Falcon®; [15052] 50ml Sarstedt® (30 x 117 mm)
[28]	*	50 ml probówka z dnem stożkowym bez rantu (30 x 115 mm), Greiner® 50 ml tube, conical bottom, without skirt (30 x 115 mm), Greiner®
		<b>13866 R max 186 RCF 3845</b>

\* probówka niedostępna w ofercie MPW lub dostępny odpowiednik (np:[15050]), patrz kolumna z prawej  
tube is not offered by MPW or equivalent is available (e.g. [15050]), see column on the right

**A. Wyposażenie dodatkowe/Optional accessories**
**MPW-380/R**

		<b>14043 Rmax 186 RCF 3845</b>
[24]	*	Greiner Vacuette® (13 x 75 mm), (1-4,5 ml)
[24]	*	5 ml probówka szklana (12 x 75 mm) 5 ml glass tube (12 x 75 mm)
[24]	*	5 ml probówka z korkiem (12 x 85 mm), Sarstedt® 5 ml tube with cap (12 x 85 mm), Sarstedt®
		<b>14071 Rmax 186 RCF 3845</b>
[24]	15055	30 ml probówka z pokrywką (25,4 x 103,2 mm) 30 ml tube with cap (25,4 x 103,2 mm)
[24]	*	28 ml Thermo Nalgene® Oak Ridge (25,4 x 101,8 mm)
[24]	*	30 ml probówka z pokrywką (25,5 x 94 mm), Nalgene® 30 ml tube with cap (25,5 x 94 mm), Nalgene®
[24]	*	30 ml Thermo Nalgene® Oak Ridge (25,5 x 94,3 mm) 30 ml Thermo Nalgene® Oak Ridge (25,5 x 94,3 mm)
[24]	*	25 ml probówka szklana (25 x 100 mm) 25 ml glass tube (25 x 100 mm)
		<b>14073 Rmax 186 RCF 3845</b>
[24]	15046	14 ml probówka z pokrywką (16,8 x 113,7 mm), Sarstedt® 14 ml tube with cap (16,8 x 113,7 mm), Sarstedt®
[24]	15053	10 ml probówka z pokrywką (16 x 106 mm) 10 ml tube with cap (16 x 106 mm)
[24]	*	BD Vacutainer® (16 x 100 mm), (2,5-11 ml)
[24]	*	Greiner Vacuette® (16 x 100 mm), (7-9 ml)
[24]	*	Sarstedt S-Monovette® (15 x 92 mm), (7,5; 8,2; 8,5 ml)
[24]	*	Sarstedt S-Monovette® (16 x 92 mm), (9; 10 ml)
[24]	15118	10 ml probówka szklana (16 x 100 mm) 10 ml glass tube (16 x 100 mm)
[24]	*	15 ml Thermo Nalgene® (16 x 113 mm) 15 ml Thermo Nalgene® (16 x 113 mm)
		<b>14089 Rmax 186 RCF 3845</b>
[4]	*	15 ml probówka z dnem stożkowym z zakrętką (17 x 120 mm), Falcon®; [15050], 15ml (17 x 120 mm) 15 ml tube, conical bottom, with cap (17 x 120 mm), Falcon®; [15050] 15ml Sarstedt®(17 x 120 mm) <b>bez wkładki/without adapter Rmax 186 RCF 3845</b>
[24]	*	50 ml probówka z dnem stożkowym z zakrętką (30 x 117 mm), Falcon®; [15052] 50ml (30 x 117mm) 50 ml tube, conical bottom, with cap (30 x 117 mm), Falcon®; [15052] 50ml Sarstedt® (30 x 117 mm)
[24]	*	50 ml probówka z dnem stożkowym bez rantu (30 x 115 mm), Greiner® 50 ml tube, conical bottom, without skirt (30 x 115 mm), Greiner®
		<b>13833+17834 R max 184 RCF 3804</b>
		<b>14845 Rmax 184 RCF 3804</b>
[72]	*	BD Vacutainer® (13 x 75 mm), (1,6-5,3 ml)
[72]	*	BD Vacutainer® (13 x 100 mm), (4-7 ml)
[72]	*	Greiner Vacuette® (13 x 75 mm), (1-4,5 ml)
[72]	*	Greiner Vacuette® (13 x 100 mm), (3,5-6 ml)
[72]	*	Sarstedt S-Monovette® (11 x 66 mm), (1,6; 2; 2,7; 3; 3,1 ml)
[72]	*	Sarstedt S-Monovette® (13 x 65 mm), (2,6; 2,9; 3,4; 3,8 ml)
[72]	*	Sarstedt S-Monovette® (13 x 75 mm), (2,7; 3; 4,3 ml)
[72]	*	Sarstedt S-Monovette® (11 x 92 mm), (4,5; 5 ml)
[72]	*	Sarstedt S-Monovette® (13 x 90 mm), (4,9; 5,6 ml)
[72]	*	5 ml probówka szklana (12 x 75 mm) 5 ml glass tube (12 x 75 mm)
[72]	*	5 ml probówka z korkiem (12 x 85 mm), Sarstedt® 5 ml tube with cap (12 x 85 mm), Sarstedt®
[72]	*	7 ml probówka szklana (12 x 100 mm) 7 ml glass tube (12 x 100 mm)
[72]	*	6 ml probówka z pokrywką (11,5 x 92 mm), Sarstedt® 6 ml tube with cap (11,5 x 92 mm), Sarstedt®
		<b>14846 Rmax 184 RCF 3804</b>
[48]	15046	14 ml probówka z pokrywką (16,8 x 113,7 mm), Sarstedt® 14 ml tube with cap (16,8 x 113,7 mm), Sarstedt®
[48]	15053	10 ml probówka z pokrywką (16 x 106 mm) 10 ml tube with cap (16 x 106 mm)
[48]	*	BD Vacutainer® (16 x 100 mm), (2,5-11 ml)
[48]	*	Greiner Vacuette® (16 x 100 mm), (7-9 ml)
[48]	*	Sarstedt S-Monovette® (15 x 92 mm), (7,5; 8,2; 8,5 ml)
[48]	*	10 ml Thermo Nalgene® Oak Ridge (16 x 81,5 mm)
[48]	15118	10 ml probówka szklana (16 x 100 mm) 10 ml glass tube (16 x 100 mm)
		<b>14848 Rmax 184 RCF 3804</b>
[20]	15055	30 ml probówka z pokrywką (25,4 x 103,2 mm) 30 ml tube with cap (25,4 x 103,2 mm)
[20]	*	28 ml Thermo Nalgene® Oak Ridge (25,4 x 101,8 mm)
[20]	*	30 ml Thermo Nalgene® Oak Ridge (25,5 x 94,3 mm) 30 ml Thermo Nalgene® Oak Ridge (25,5 x 94,3 mm)
[20]	*	25 ml probówka szklana (25 x 100 mm) 25 ml glass tube (25 x 100 mm)
		<b>14849 Rmax 184 RCF 3804</b>

\* probówka niedostępna w ofercie MPW lub dostępny odpowiednik (np.[15050]), patrz kolumna z prawej  
tube is not offered by MPW or equivalent is available (e.g. [15050]), see column on the right

**A. Wyposażenie dodatkowe/Optional accessories**
**MPW-380/R**

[16]	*	50 ml probówka z dnem stożkowym z zakrętką (30 x 117 mm), Falcon®; [15052] 50ml (30 x 117mm) 50 ml tube, conical bottom, with cap (30 x 117 mm), Falcon®; [15052] 50ml Sarstedt® (30 x 117 mm)
[16]	*	50 ml probówka z dnem stożkowym bez rantu (30 x 115 mm), Greiner® 50 ml tube, conical bottom, without skirt (30 x 115 mm), Greiner®
		<b>14850 Rmax 184 RCF 3804</b>
[4]	15040	100 ml probówka z pokrywką (45,2 x 103,7 mm) 100 ml tube with cap (45,2 x 103,7 mm)
[4]	*	100 ml probówka szklana (44 x 100 mm) 100 ml glass tube (44 x 100 mm)
		<b>14853 Rmax 184 RCF 3804</b>
[84]	*	2-1,5 ml probówka (10,8x41,8 mm), Eppendorf®; [15011], 2 ml (10,8x41,8 mm); [15128], 1,5ml (10,8x40,5 mm)
[84]	*	2 ml próbki z filtrem - spin columns (10,8 x 46 mm) 2 ml spin columns (with filter) (10,8 x 46 mm); [15011], 2 ml (10,8x41,8 mm); [15128], 1,5ml
		<b>14854 Rmax 184 RCF 3804</b>
[4]	15440	200 ml butelka płaskodenna (56 x 112 mm), Herolab® nr 25 33 73 200 ml bottle, flat bottom (56 x 112 mm), Herolab® no. 25 33 73
		<b>14861 Rmax 184 RCF 3804</b>
[96]	*	Sarstedt S-Monovette® (8 x 66 mm), (1,1; 1,2; 1,4 ml) Sarstedt S-Monovette® (8 x 66 mm), (1,1; 1,2; 1,4 ml)
		<b>14867 Rmax 184 RCF 3804</b>
[36]	*	15 ml probówka z dnem stożkowym z zakrętką (17 x 120 mm), Falcon®; [15050], 15ml (17 x 120 mm) 15 ml tube, conical bottom, with cap (17 x 120 mm), Falcon®; [15050] 15ml Sarstedt®(17 x 120 mm)
		<b>bez wkładki/without adapter Rmax 184 RCF 3804</b>
[4]	15852	500 ml butelka (84 x 135 mm), Herolab® nr 25 36 11 500 ml bottle (84 x 135 mm), Herolab® no. 25 36 11
		<b>14851+14017 Rmax 184 RCF 3804</b>
[4]	*	250 ml butelka okrągłodenna (62 x 122 mm), Herolab® nr 25 34 43 250 ml round-bottom bottle (62 x 122 mm), Herolab® no. 25 34 43
		<b>14847 Rmax 184 RCF 3804</b>
[48]	15050	15 ml probówka z dnem stożkowym z zakrętką (17 x 120 mm), Sarstedt® 15 ml tube, conical bottom, with cap (17 x 120 mm), Sarstedt®
		<b>14859 Rmax 184 RCF 3804</b>
[12]	*	50 ml probówka szklana (35 x 100 mm) 50 ml glass tube (35 x 100 mm)
		<b>14850+14159 Rmax 184 RCF 3804</b>
[4]	*	50 ml probówka szklana (35 x 100 mm) 50 ml glass tube (35 x 100 mm)
<b>12901</b>		
		<b>RPM 4100 RCF 3533 Rmax 188 <math>\alpha</math> 90</b>
<b>13975</b>		
		<b>bez wkładki/without adapter</b>
[4]	*	750ml butelka (100x130mm), Herolab® nr 25 37 35 750 ml bottle (100 x 130 mm), Herolab® no. 25 37 35
		<b>14902</b>
[28]	*	50 ml probówka z dnem stożkowym z zakrętką (30 x 117 mm), Falcon®; [15052] 50ml (30 x 117mm) 50 ml tube, conical bottom, with cap (30 x 117 mm), Falcon®; [15052] 50ml Sarstedt® (30 x 117 mm)
[28]	*	50 ml probówka z dnem stożkowym bez rantu (30 x 115 mm), Greiner® 50 ml tube, conical bottom, without skirt (30 x 115 mm), Greiner®
		<b>14903</b>
[88]	*	BD Vacutainer® (16 x 100 mm), (2,5-11 ml)
[88]	*	Greiner Vacuette® (16 x 100 mm), (7-9 ml)
[88]	*	10 ml Thermo Nalgene® Oak Ridge (16 x 81,5 mm)
[88]	15118	10 ml probówka szklana (16 x 100 mm) 10 ml glass tube (16 x 100 mm)
[88]	*	15 ml Thermo Nalgene® (16 x 113 mm) 15 ml Thermo Nalgene® (16 x 113 mm)
		<b>14904</b>
[100]	*	BD Vacutainer® (13 x 75 mm), (1,6-5,3 ml)
[100]	*	BD Vacutainer® (13 x 100 mm), (4-7 ml)
[100]	*	Greiner Vacuette® (13 x 75 mm), (1-4,5 ml)
[100]	*	Greiner Vacuette® (13 x 100 mm), (3,5-6 ml)
[100]	*	Sarstedt S-Monovette® (13 x 65 mm), (2,6; 2,9; 3,4; 3,8 ml)
[100]	*	Sarstedt S-Monovette® (13 x 75 mm), (2,7; 3; 4,3 ml)
[100]	*	Sarstedt S-Monovette® (13 x 90 mm), (4,9; 5,6 ml)
[100]	*	7 ml probówka szklana (12 x 100 mm) 7 ml glass tube (12 x 100 mm)
[100]	*	5 ml probówka szklana (12 x 75 mm) 5 ml glass tube (12 x 75 mm)
		<b>14901</b>
[56]	*	15 ml probówka z dnem stożkowym z zakrętką (17 x 120 mm), Falcon®; [15050], 15ml (17 x 120 mm) 15 ml tube, conical bottom, with cap (17 x 120 mm), Falcon®; [15050] 15ml Sarstedt®(17 x 120 mm)
		<b>13976+17976</b>
		<b>bez wkładki/without adapter</b>

\* probówka niedostępna w ofercie MPW lub dostępny odpowiednik (np.[15050]), patrz kolumna z prawej  
tube is not offered by MPW or equivalent is available (e.g. [15050]), see column on the right

**A. Wyposażenie dodatkowe/Optional accessories****MPW-380/R**

[4]	*	750ml butelka (100x130mm), Herolab® nr 25 37 35 750 ml bottle (100 x 130 mm), Herolab® no. 25 37 35
<b>14902</b>		
[28]	*	50 ml probówka z dnem stożkowym z zakrętką (30 x 117 mm), Falcon®; [15052] 50ml (30 x 117mm) 50 ml tube, conical bottom, with cap (30 x 117 mm), Falcon®; [15052] 50ml Sarstedt® (30 x 117 mm)
[28]	*	50 ml probówka z dnem stożkowym bez rantu (30 x 115 mm), Greiner® 50 ml tube, conical bottom, without skirt (30 x 115 mm), Greiner®
<b>14903</b>		
[88]	*	BD Vacutainer® (16 x 100 mm), (2,5-11 ml)
[88]	*	Greiner Vacuette® (16 x 100 mm), (7-9 ml)
[88]	*	10 ml Thermo Nalgene® Oak Ridge (16 x 81,5 mm)
[88]	15118	10 ml probówka szklana (16 x 100 mm) 10 ml glass tube (16 x 100 mm)
[88]	*	15 ml Thermo Nalgene® (16 x 113 mm) 15 ml Thermo Nalgene® (16 x 113 mm)
<b>14904</b>		
[100]	*	BD Vacutainer® (13 x 75 mm), (1,6-5,3 ml)
[100]	*	BD Vacutainer® (13 x 100 mm), (4-7 ml)
[100]	*	Greiner Vacuette® (13 x 75 mm), (1-4,5 ml)
[100]	*	Greiner Vacuette® (13 x 100 mm), (3,5-6 ml)
[100]	*	Sarstedt S-Monovette® (13 x 65 mm), (2,6; 2,9; 3,4; 3,8 ml)
[100]	*	Sarstedt S-Monovette® (13 x 75 mm), (2,7; 3; 4,3 ml)
[100]	*	Sarstedt S-Monovette® (13 x 90 mm), (4,9; 5,6 ml)
[100]	*	7 ml probówka szklana (12 x 100 mm) 7 ml glass tube (12 x 100 mm)
[100]	*	5 ml probówka szklana (12 x 75 mm) 5 ml glass tube (12 x 75 mm)
<b>14901</b>		
[56]	*	15 ml probówka z dnem stożkowym z zakrętką (17 x 120 mm), Falcon®; [15050], 15ml (17 x 120 mm) 15 ml tube, conical bottom, with cap (17 x 120 mm), Falcon®; [15050] 15ml Sarstedt®(17 x 120 mm)

**Suma końcowa**

## EU DECLARATION OF CONFORMITY

This EU declaration of conformity is issued under the sole responsibility of the manufacturer.

**Manufacturer:** "MPW MED. INSTRUMENTS" SPÓŁDZIELNIA PRACY  
46 Boremlowska Street, 04-347 Warsaw, Poland

**The Quality Management System complies with the standards:** PN-EN ISO 9001:2015, PN-EN ISO 13485:2016

**SRN:** PL-MF-000032831

**Device name:** Laboratory centrifuge MPW-380  
(with the accessory indicated in the operating instructions provided with the centrifuge)

**BASIC UDI-DI:** 590538636-IVD-CEN-011-62

**Catalogue numbers:** 10380/2-56                      10380/1-56                      10380/1-56/100  
10380/1-56/110                      10380/1-56/127

The aforementioned device is in conformity with the following EU regulations and directives:

**2017/746 (IVDR)** REGULATION (EU) 2017/746 OF THE EUROPEAN PARLIAMENT AND OF THE COUNCIL of 5 April 2017 on in vitro diagnostic medical devices and repealing Directive 98/79/EC and Commission Decision 2010/227/EU, including the changes published prior to the date of this declaration.

**2011/65/EU (RoHS 2)** DIRECTIVE 2011/65/EU OF THE EUROPEAN PARLIAMENT AND OF THE COUNCIL of 8 June 2011 on the restriction of the use of certain hazardous substances in electrical and electronic equipment, including the changes published prior to the date of this declaration.

**Intended purpose:** The device is intended for the separation of the mixtures of the liquid substances derived from the human body, including blood, urine, and other body fluids, and for the preparation of the samples intended for further in vitro diagnostics procedures.

**Risk class:** Class A  
(in accordance with the rule 5 of Annex VIII of Regulation (EU) 2017/746).

The conformity assessment of the device and accessory has been carried out in accordance with Article 48(10) of Regulation (EU) 2017/746.

**Wojciech Anisiewicz**  
Vice-President of the Management Board

**Łukasz Szański**  
President of the Management Board



## EU DECLARATION OF CONFORMITY

This EU declaration of conformity is issued under the sole responsibility of the manufacturer.

**Manufacturer:** "MPW MED. INSTRUMENTS" SPÓŁDZIELNIA PRACY  
46 Boremlowska Street, 04-347 Warsaw, Poland

**The Quality Management System complies with the standards:** PN-EN ISO 9001:2015, PN-EN ISO 13485:2016

**SRN:** PL-MF-000032831

**Device name:** Refrigerated laboratory centrifuge MPW-380R  
(with the accessory indicated in the operating instructions provided with the centrifuge)

**BASIC UDI-DI:** 590538636-IVD-CEN-012-65

**Catalogue numbers:** 10380R/2-56                      10380R/1-6                      10380R/1-6/100  
10380R/1-6/110                      10380R/1-6/127

**The aforementioned device is in conformity with the following EU regulations and directives:**

**2017/746 (IVDR)** REGULATION (EU) 2017/746 OF THE EUROPEAN PARLIAMENT AND OF THE COUNCIL of 5 April 2017 on in vitro diagnostic medical devices and repealing Directive 98/79/EC and Commission Decision 2010/227/EU, including the changes published prior to the date of this declaration.

**2011/65/EU (RoHS 2)** DIRECTIVE 2011/65/EU OF THE EUROPEAN PARLIAMENT AND OF THE COUNCIL of 8 June 2011 on the restriction of the use of certain hazardous substances in electrical and electronic equipment, including the changes published prior to the date of this declaration.

**Intended purpose:** The device is intended for the separation of the mixtures of the liquid substances derived from the human body, including blood, urine, and other body fluids, and for the preparation of the samples intended for further in vitro diagnostics procedures.

**Risk class:** Class A  
(in accordance with the rule 5 of Annex VIII of Regulation (EU) 2017/746).

**The conformity assessment of the device and accessory has been carried out in accordance with Article 48(10) of Regulation (EU) 2017/746.**

**Wojciech Anisiewicz**  
Vice-President of the Management Board

**Łukasz Satański**  
President of the Management Board

# DECLARATION OF DECONTAMINATION

(repair)

In order to protect our employees please fill out the declaration of decontamination completely before sending centrifuge to the manufacturer (repair).

If it is impossible to completely and effectively decontaminate the device, it should be treated in accordance with the regulations for medical waste.

**1. Device:**

– type: .....  
– serial No.: .....

**2. Description of decontamination**

(see user manual)

.....  
.....  
.....  
.....

**3. Decontamination carried out by:**

name: .....

**4. Date and signature:**

.....

# DECLARATION OF DECONTAMINATION

(return)

In order to protect our employees please fill out the declaration of decontamination completely before sending centrifuge to the manufacturer (return).

If it is impossible to completely and effectively decontaminate the device, it should be treated in accordance with the regulations for medical waste.

**1. Device:**

– type: .....

– serial No.: .....

**2. Description of decontamination**

(see user manual)

.....

.....

.....

.....

**3. Decontamination carried out by:**

name: .....

**4. Date and signature:**

.....



# NOMOGRAM

Centrifuging radius [cm]

R.C.F. (x "g")  
multiple of  
gravitational  
acceleration

[r.p.m.]

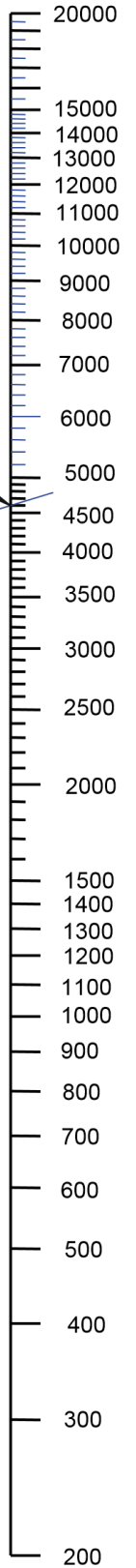
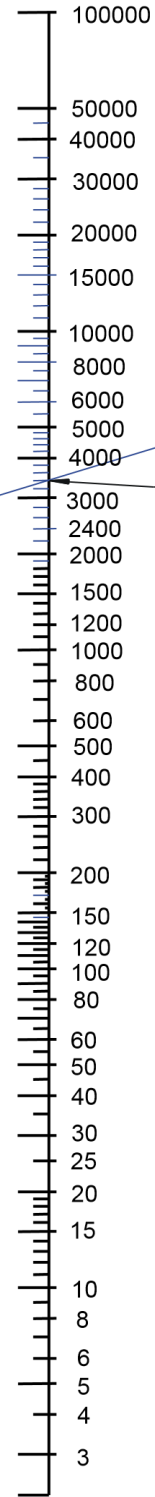
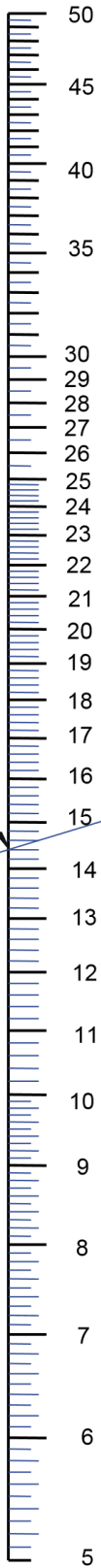

Formula used for calculation of this nomogram :

$$R.C.F. = 11,18 * r * (n/1000)^2$$

where :

- R.C.F. - multiple of gravitational acceleration
- r - centrifuging radius (cm)
- n - rotational speed (r.p.m.)
- g - gravitational acceleration

Example of making use  
of the nomogram:

A=14,4 cm  
B=4600 r.p.m.  
C=3400 x g

$$n = 1000 * \sqrt{\frac{RCF}{(11,18 * r)}}$$

$$r = \frac{RCF}{\left[ 11,18 * \left( \frac{n}{1000} \right)^2 \right]}$$

A

B

C